

Barbie

# Knit Hits™ Fashion Maker

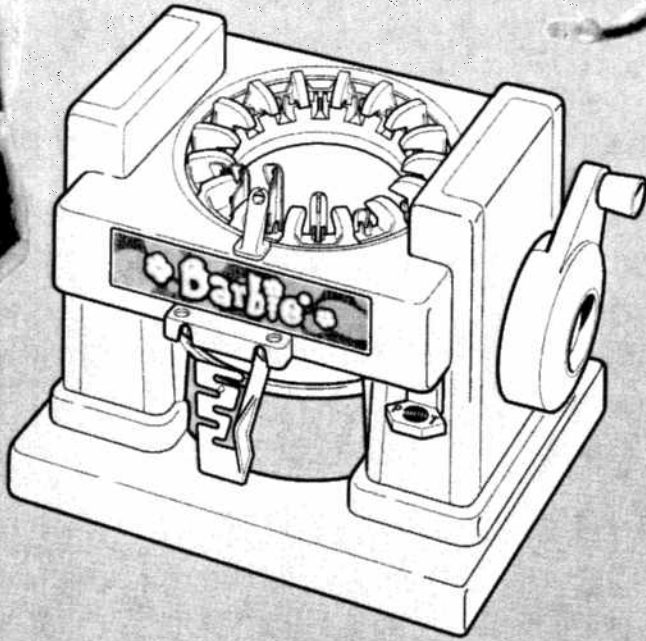

*Dolls not included.*

**Everything you need to make  
2 Barbie® doll dresses, 2 hand bags (one for you,  
one for Barbie® doll), 1 hair tie and 1 headband.  
Includes yarn, accent beads & more!**

22900-0920G



*Keep these instructions for future reference, as they contain important information.*

© 1998 Mattel, Inc., El Segundo, CA 90245. U.S.A. All Rights Reserved.

**Contents:**

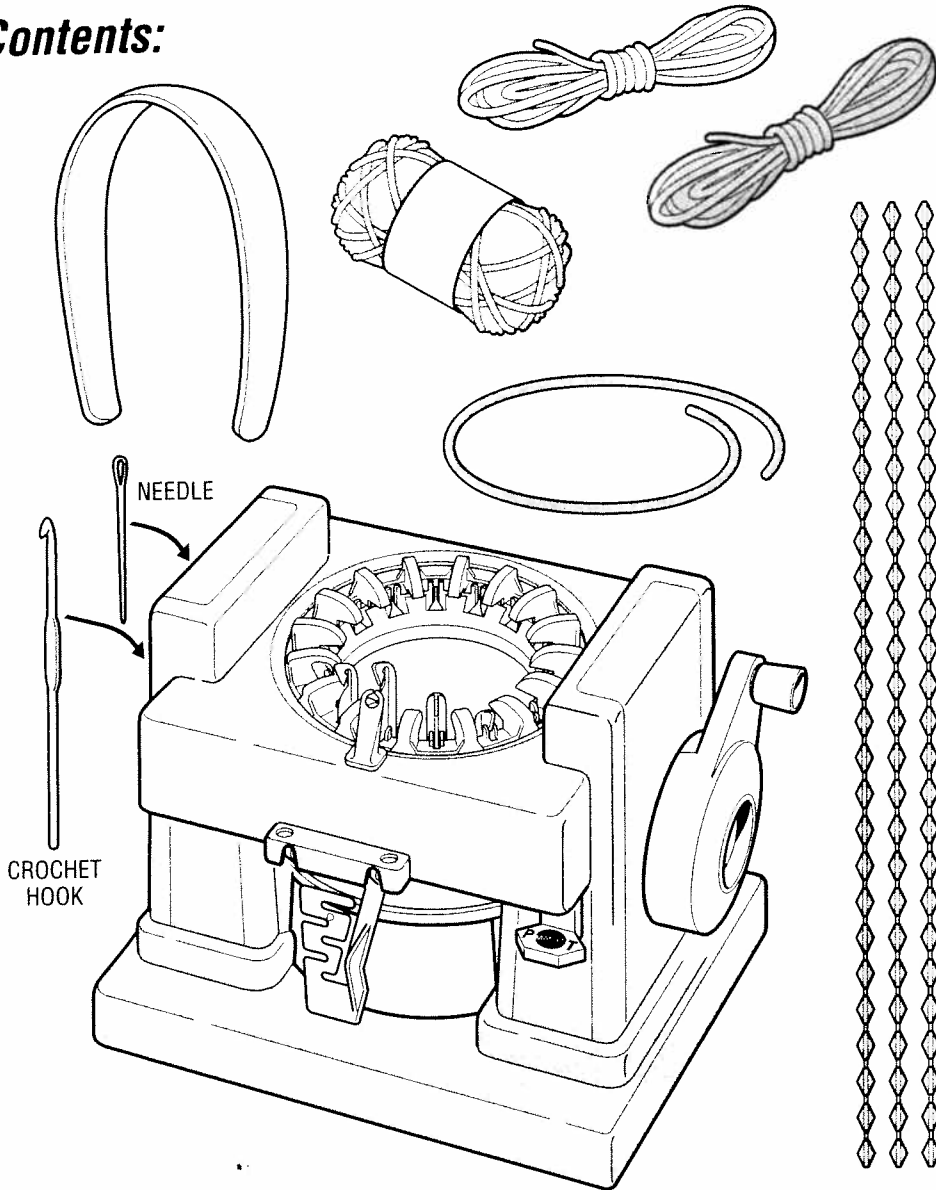

Please remove everything from the package and compare to the contents shown here.  
If any items are missing, please call 1-800-524-TOYS.

**ADULT ASSISTANCE REQUIRED.**

**Adult:** We suggest you go through the instructions and practice the lessons with your child.

Create your own knit hits! It's so easy, but before you start any project it's important to read and do all of the lessons. Each lesson will show you everything you will need to know to make totally cool outfits for Barbie® doll and trendy accessories for you!

For best results, practice the lessons several times before you start a project.

## Table of Contents:

<b>THINGS TO WATCH FOR WHEN KNITTING</b> .....	2
<b>KINDS OF YARN TO USE</b> .....	2
<b>DEFINITIONS</b> .....	2
<b>LESSON 1:</b>	
How To Knit A Tube .....	3
How To Remove A Knitted Tube .....	5
How To Finish Open Tube Ends .....	6
How To Close Tube Ends .....	7
<b>LESSON 2:</b>	
How To Knit A Panel .....	8
How To Close Panel Ends .....	10
<b>PROJECTS:</b>	
Jacket .....	11
Tubes for Fashions.....	12
Tubes for Accessories.....	13
How To Change The Color of Yarn.....	13
Basic Dress.....	14
Dress .....	15
Bikini.....	16
Sweater with Glitter Yarn .....	17
Purse with Glitter Yarn.....	17
Barbie® Doll Accessories (Purse, Hat, Scarf).....	18
Child Accessories (Handbag, Hair Tie, Headband).....	19
Crochet A Chain .....	20
Trouble Shooting .....	21

## Things to Watch For When Knitting:

If your Knit Hits™ Fashion Maker handle becomes hard to turn:

1. There is not enough slack between the machine and skein of yarn. Unravel more yarn from the skein.
2. Yarn is jamming in machine hooks. Remove yarn from machine hooks.

### NOTE:

- If the yarn tension arm comes off the Fashion Maker, snap it back in place.
- If the Fashion Maker makes a hard snapping noise: There is too much back tension.
- If your knitting Fashion Maker misses stitches or is knitting too loose, you need more back tension. Wind more turns on tension arm to suit.

## Kinds of Yarn To Use:

Your Knit Hits™ Fashion Maker has been designed to use:

- 3-ply yarn (wool, acrylic, polyester)
- Shimmery yarn.

Four-ply yarn may be used with care. You may use any kind of fiber: Wool, Acrylic, Polyester. Get creative! Use shimmery yarn to create elegant fashions, or mix-and-match colors for a more trendy look. Stretchy yarn (3-ply) will make great looking fashions, too! It's all up to you, let your imagination go wild!

## Definitions:

**Skein:** Yarn wound in a coil.

**Slack:** To be loose; not tight from skein to tension arm.

**Tension:** Tightness (in yarn) from tension arm to guide.

**Back Tension:** Too much tightness (in yarn) from tension arm to guide.

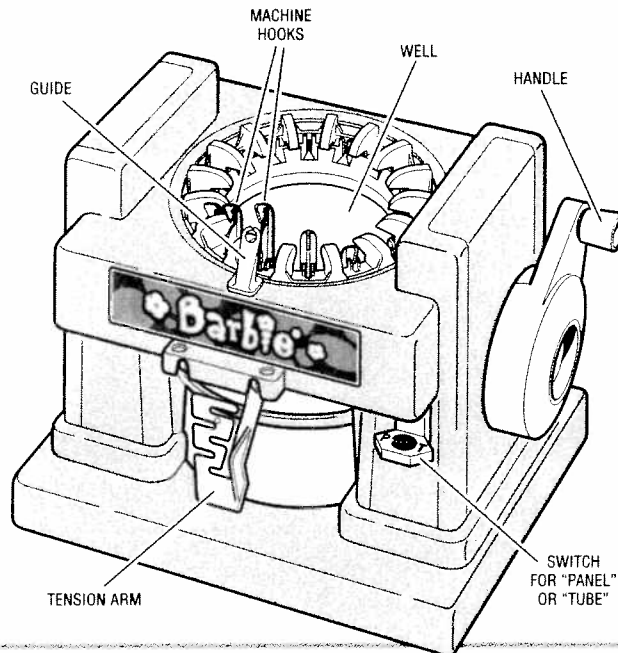

2.

# Lesson 1

## How To Knit A Tube

You can make every project in the Knit Hits™ Fashion Maker from either a TUBE or a PANEL.

**Before you start ANY project, do the lessons.**

1. Move the switch to the **TUBE**, "T" position. Find the loose end of yarn on the **INSIDE** of the yarn roll. Drop the end of yarn through the well of the machine until it touches the table top.

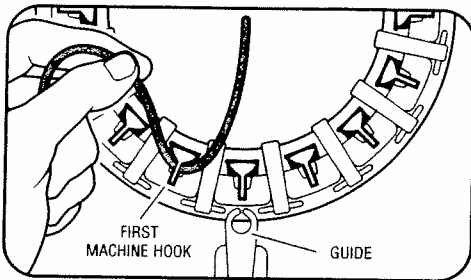
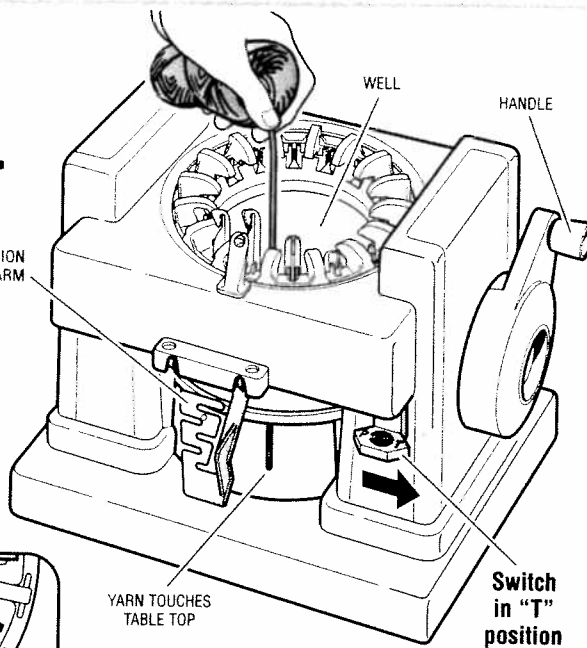

2. Drape yarn under the first machine hook, **LEFT** of the guide.

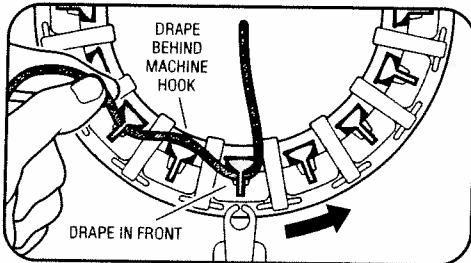

3. With your right hand, turn the handle **AWAY** (clockwise) from you. Drape the yarn **BEHIND** the next hook.

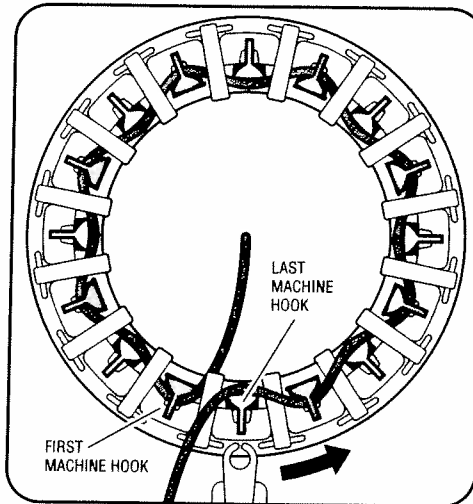

4. Continue to turn the handle. On the next hook, drape the yarn in **FRONT** under the hook. Alternate **FRONT** to **BACK** until all hooks are threaded.

**5.**

Loop yarn through the guide. Raise the tension arm. Slide yarn into the top slot.

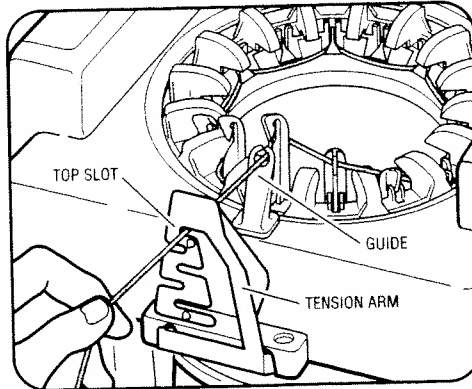

**6.**

Thread the yarn over and through to the second slot. Under and through to the third slot. Over and through to the fourth slot. Under to the fifth slot.

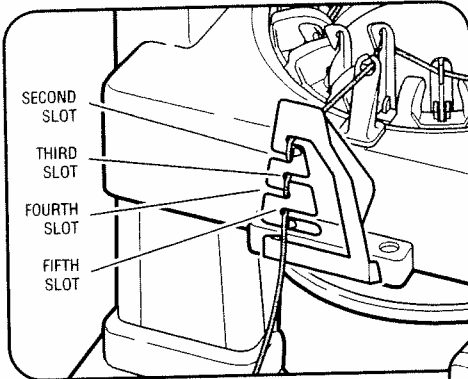

**7.**

You are ready to practice knitting a tube. Turn handle *AWAY* from you. When you have made several complete rows, check for missed stitches. A missed stitch will cause a hole to appear in the side of the knitted tube. If a stitch was missed, start over. (*See Step 8 for removing knitting from machine.*)

Practice knitting until the tube is to the first ridge in the well.

If the handle becomes hard to turn, there is not enough slack between the machine and skein of yarn. Unravel more yarn from the skein.

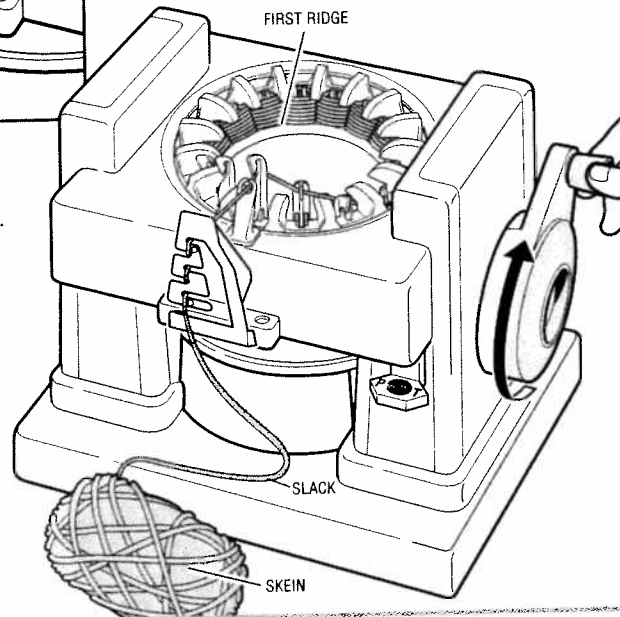

## How To Remove A Knitted Tube

**8.**

Unwind the yarn from tension arm and guide. Hold the loose yarn over the well of the machine. Turn the handle **AWAY** from you. As the well moves, the tube is released from the machine.

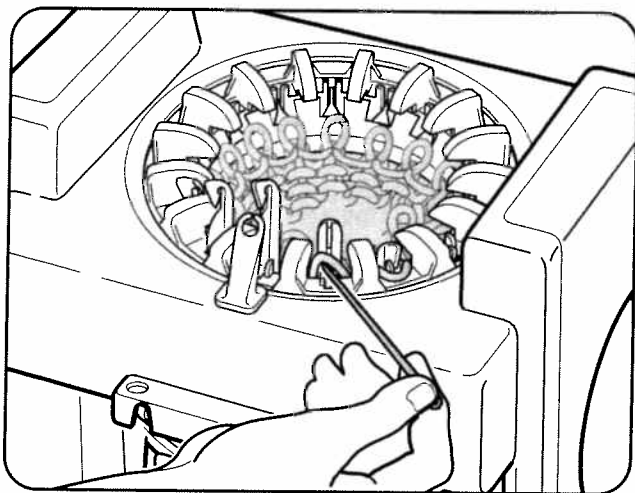
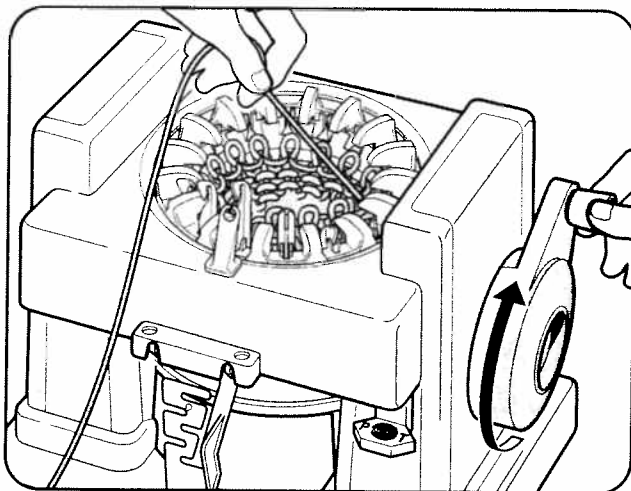

**9.**

If there is still one or two loops attached, gently remove them with your fingers, or with the needle or crochet hook. Lift knitted tube out of well.

**10.**

Hold the finished tube at each end and pull. Stretch to make the stitches firm.

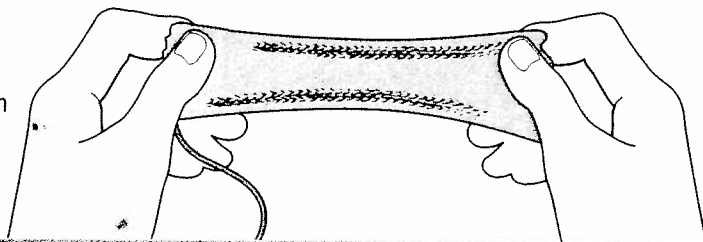

## How To Finish Open Tube Ends

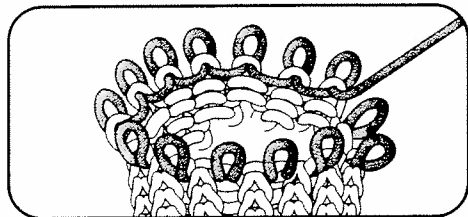
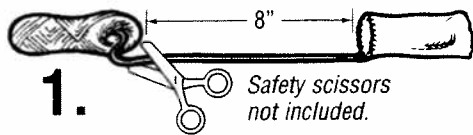

2. **Unravel 2 complete rows of loops** (to make loops easier to see).

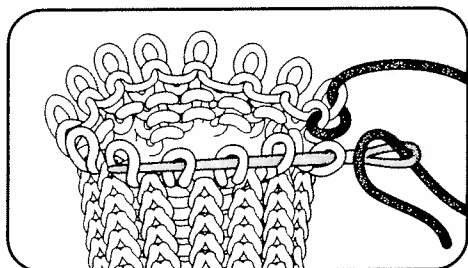

3. **Thread the needle and push the needle through the loops on one side.**

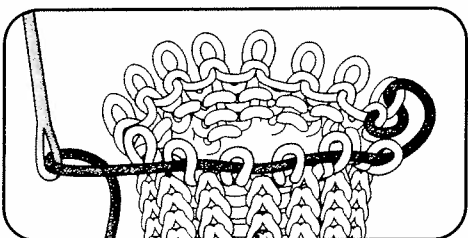

4. **Then, guide the needle through the loops.**

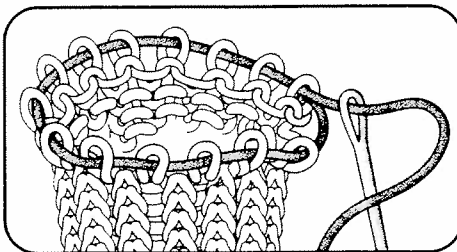

5. **Now, wiggle the needle through the remaining loops.**

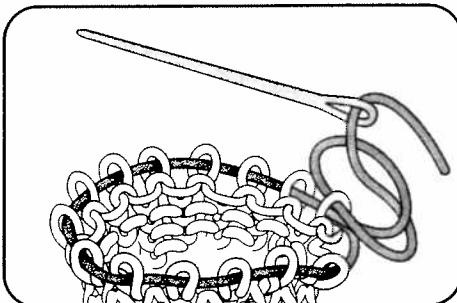

6. **Tie a knot as shown.**

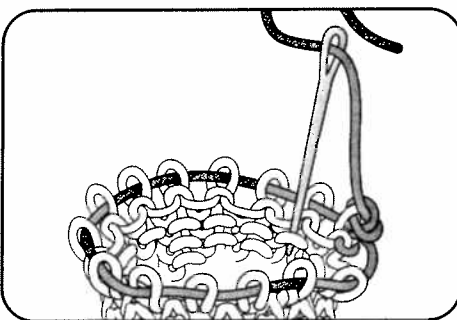

7. **Now, pull the needle inside through two stitches and cut off.**



# How To Close Tube Ends

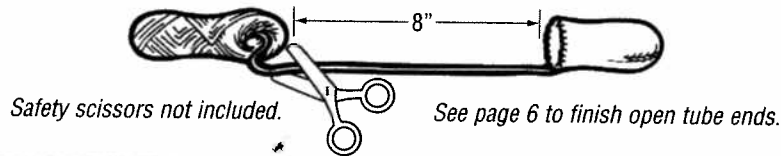
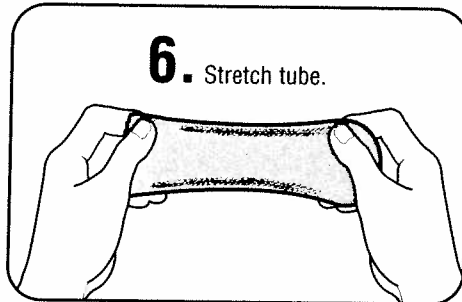
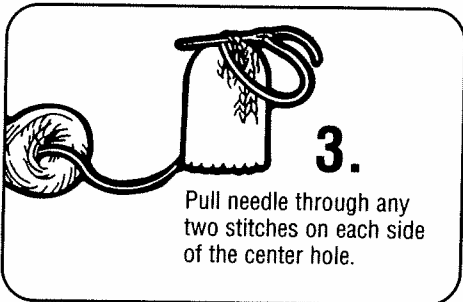
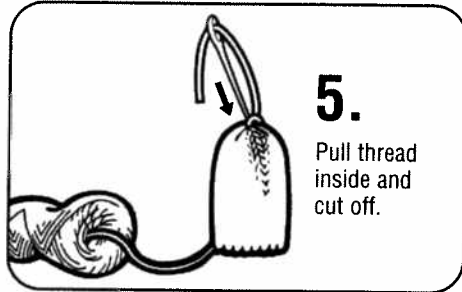
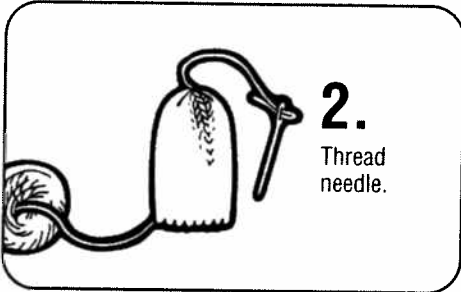
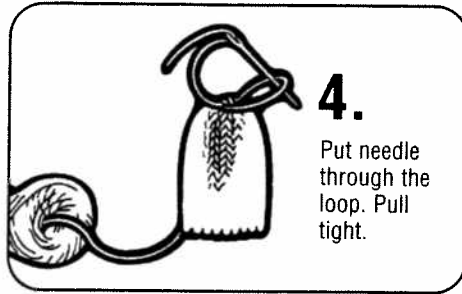
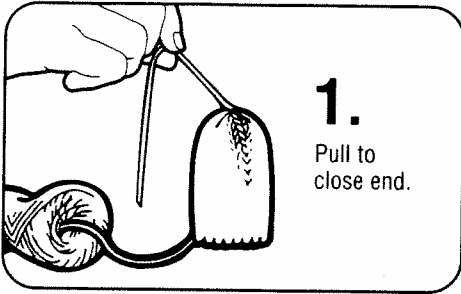

# Lesson 2

## How To Knit A Panel

1. Move your Switch to the "P" position. "P" means you'll be knitting a "panel". Turn handle toward you (counter clockwise) until it stops. Drop the free end of the yarn into the center of the machine as you did before.

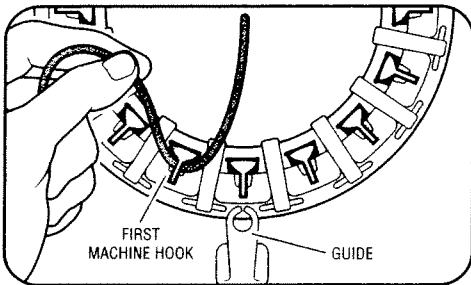
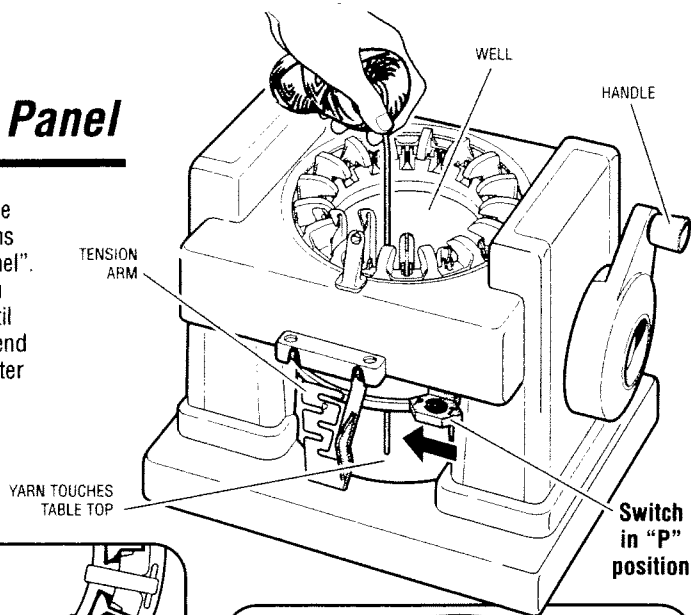

2. Drape yarn under the first machine hook to the LEFT of the guide.

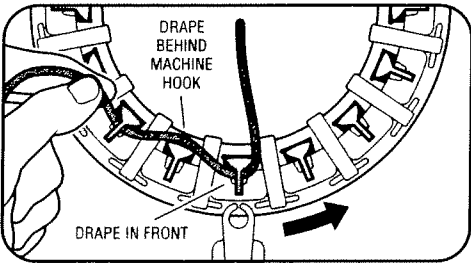

3. With your right hand; turn the handle AWAY (clockwise) from you. Drape the yarn BEHIND the next hook.

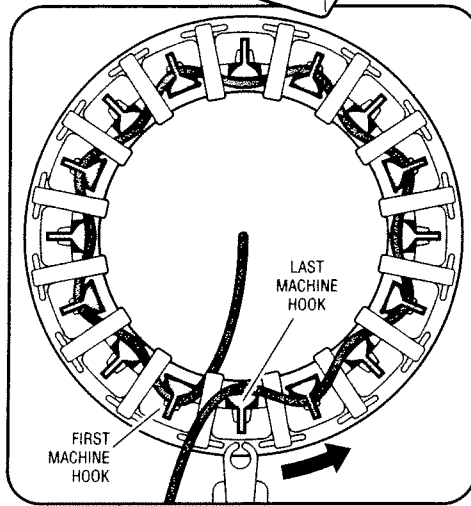

4. Continue to turn the handle. On the next hook, drape the yarn in front under the hook. Alternate front to back until all hooks are threaded. Place the yarn into the guide and tension arm as before. Continue to turn the handle away from you until it stops.

- 5.** Now start turning handle toward you until it stops. Do this back and forth until you have completed 30 rows. Every time it stops you have completed one row. Be sure to keep count. When you reach 30, your panel is finished.

### IMPORTANT!

Once you start turning in a direction – don't stop. Keep turning until handle stops. Don't stop knitting in the middle of a row. Keep tension consistent. To avoid dropping stitches – learn to knit slowly. Gradually increase your speed as your skill improves. Knitting too fast causes stitches to drop.

When knitting, the tension arm will move up and down to adjust slack. **WHEN YOU REACH A STOP, THE TENSION ARM SHOULD ALWAYS BE UP.** Check the (3-ply) yarn to be sure it is always threaded in all tension arm slots. If the handle becomes hard to turn, there is not enough slack between the machine and skein of yarn. Unravel more yarn from the skein.

- 6.** Remove panel from machine the same as you removed tube. First move switch to "T" position. Remove yarn from tension arm and guide. Hold yarn over center of machine. Turn handle away from you until top loops release from hooks. Remove panel.

- 7.** Hold your knitted panel at each end and stretch it apart as shown. Your panel should be about 5" or 12.5 cm long.

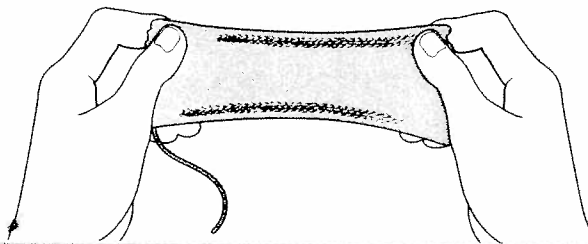
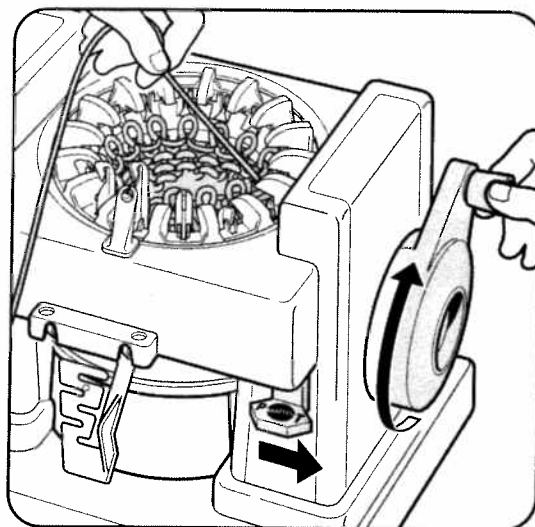
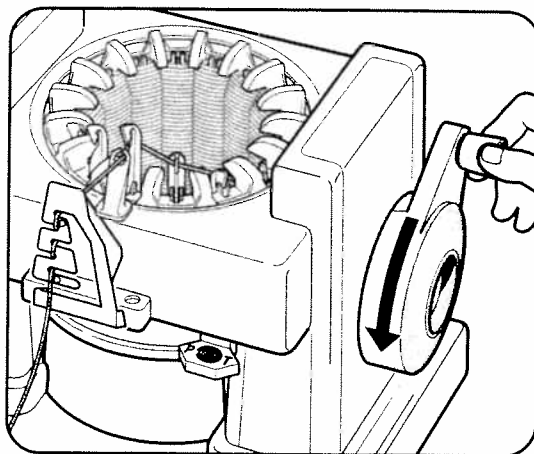

# How To Close Panel Ends

**8.**

To keep the stitches from unraveling, the end of the panel must be knotted. Thread the loose end of yarn into your needle. Pull the needle and yarn through all loops.

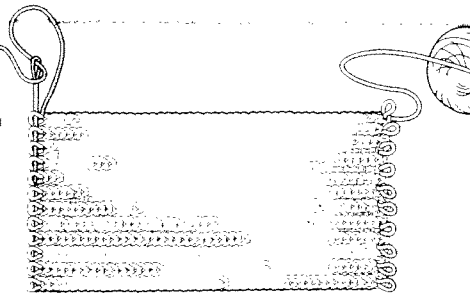

**9.**

Tie a knot through the last loop.

SNIP OFF 1/4" TO 1/2" OF YARN AND TUCK INTO KNITTED STRANDS

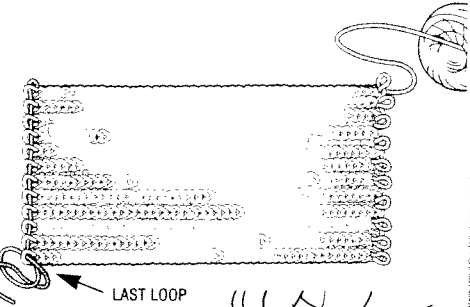
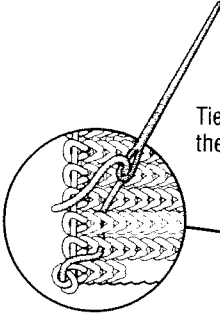

**10.**

Before you knot the panel end attached to the skein of yarn, unravel 2 complete rows of stitches until the loose yarn is hanging from an end loop. (This will make the loops easier to thread). Cut off the yarn about 8" or 20 cm from the panel. Use safety scissors (not included).

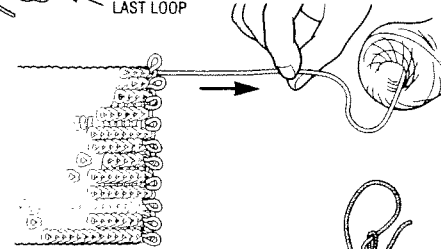

**11.**

Thread your needle. Push it through all loops.

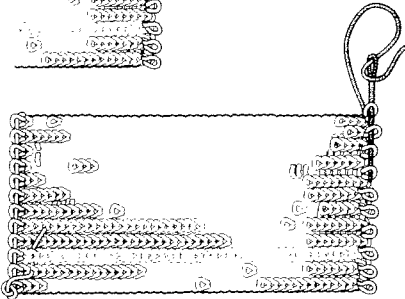

**12.**

Tie a knot through the last loop. YOU ARE NOW READY TO MAKE A PROJECT.

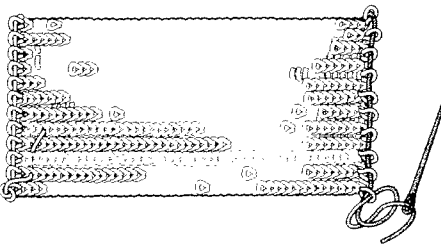

# Panels: Jacket



Doll not included.

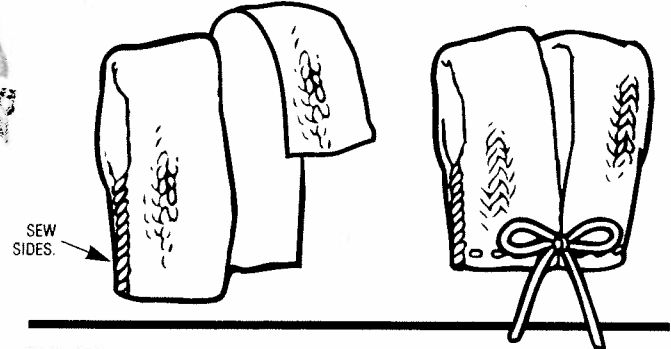
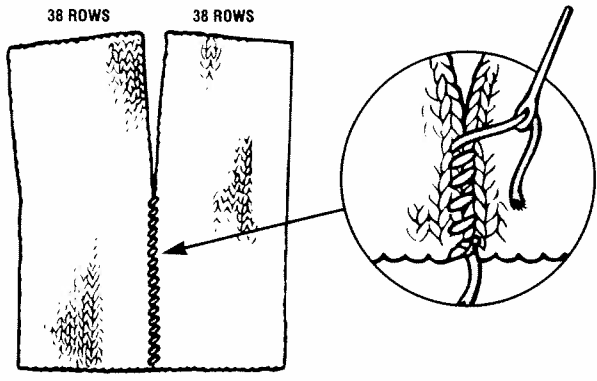

# Tube: Jacket

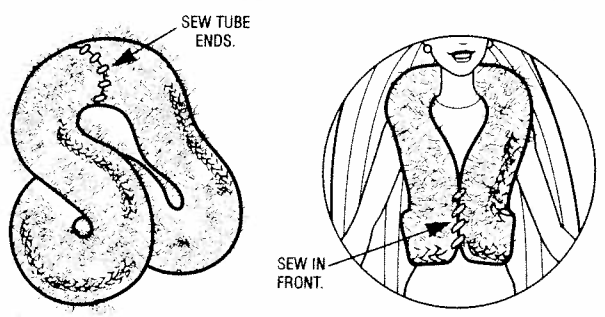
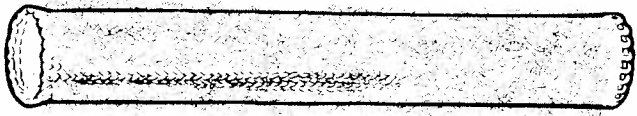

# Tubes: For Fashions

## Long Dress

(Page 15)  
57 Rows

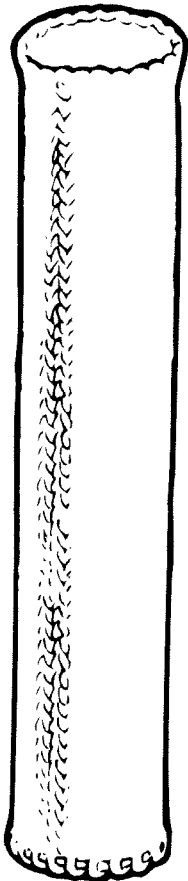

## Short Dress

(Page 15)  
32 Rows

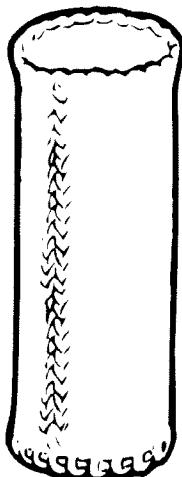

## Sweater

(Page 17)  
22 Rows

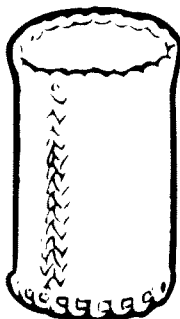

## Bikini Top

(Page 16)  
11 Rows



## Bikini Bottom

(Page 16)  
17 Rows

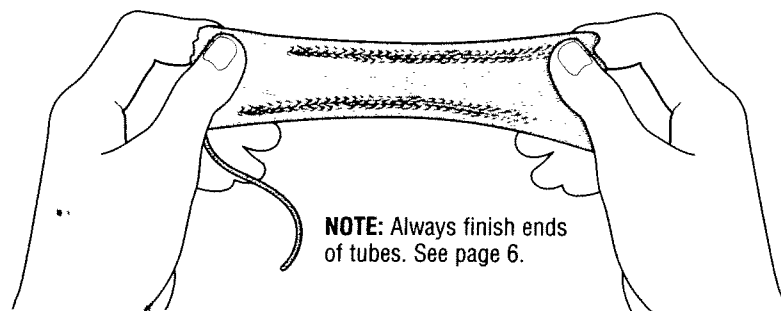
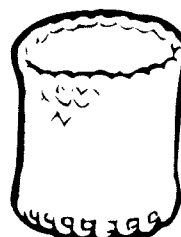

**NOTE:** Always finish ends of tubes. See page 6.

# Tubes: For Accessories

## Scarf

(Page 18)  
48 Rows

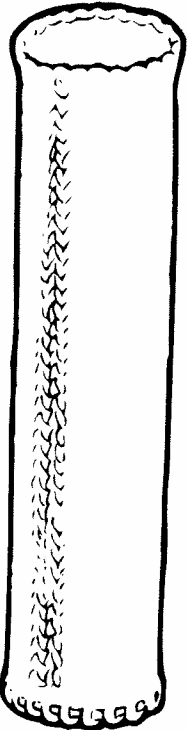

## Hat or Tall Purse

(Page 18)  
17 Rows

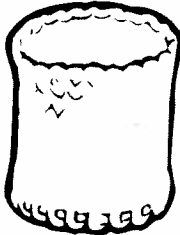

## Short Purse

(Page 18)  
17 Rows

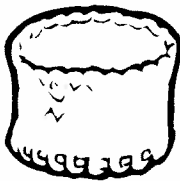

## How To Change the Color of Yarn

To use more than one color, all you do is tie one strand to another – it's that easy. The knot will not show when your project is finished. You can use as many colors as you like.

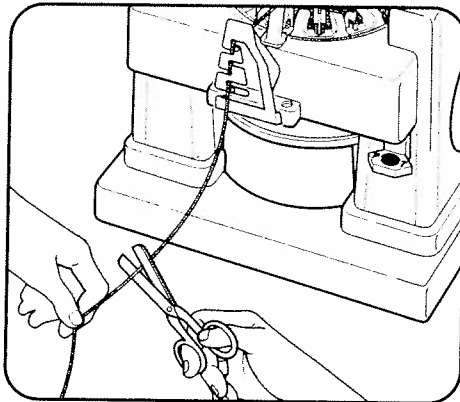

1. Cut yarn with safety scissors (not included).

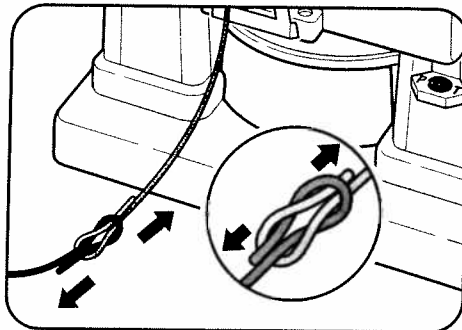

2. Tie knot and snip off ends. Continue knitting.

# Tube: Basic Dress



Doll not included.

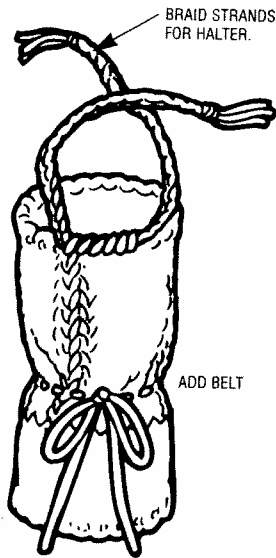
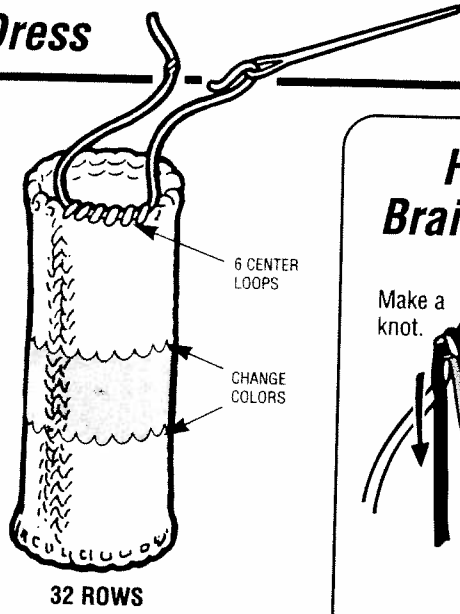

## How To Braid Strands

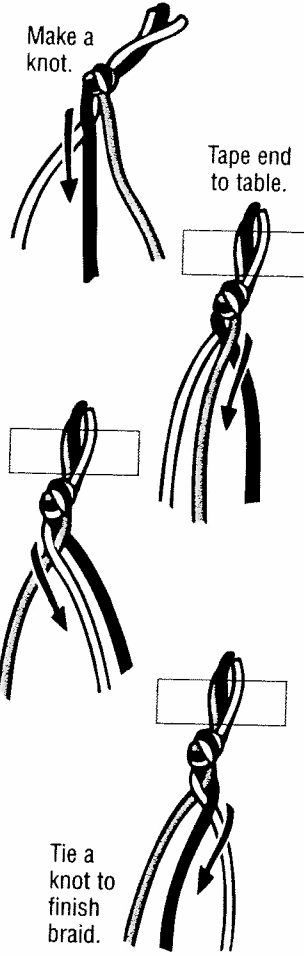



# Tube: Dress



**Short Dress**

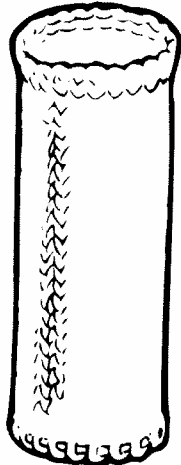

32 ROWS

**Long Dress**

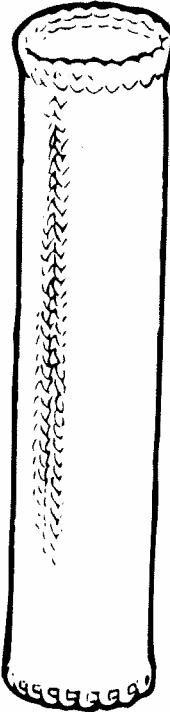

57 ROWS

**Alternate Collar**

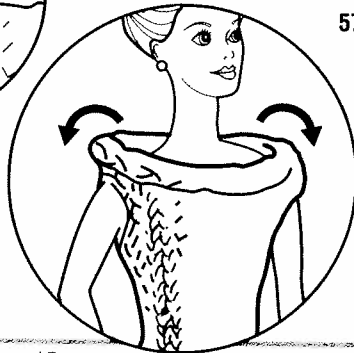
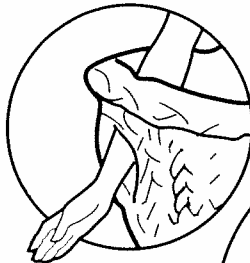

*Doll not included.*

# Tube: Bikini



Doll not included.

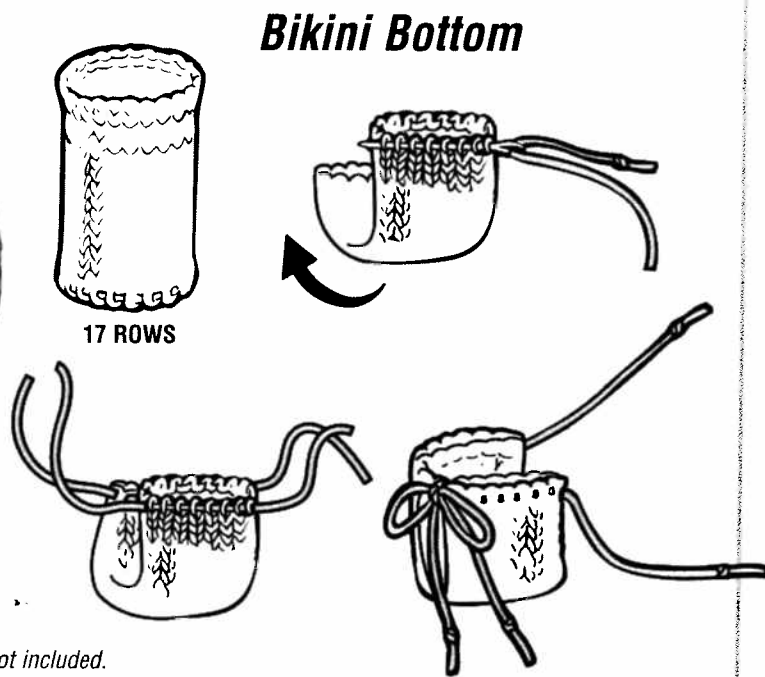
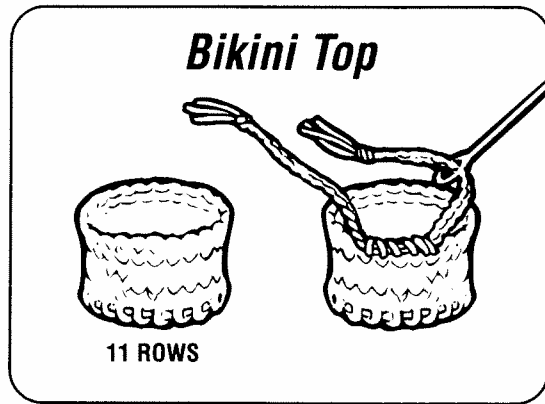

# Tube: Sweater With Glitter Yarn

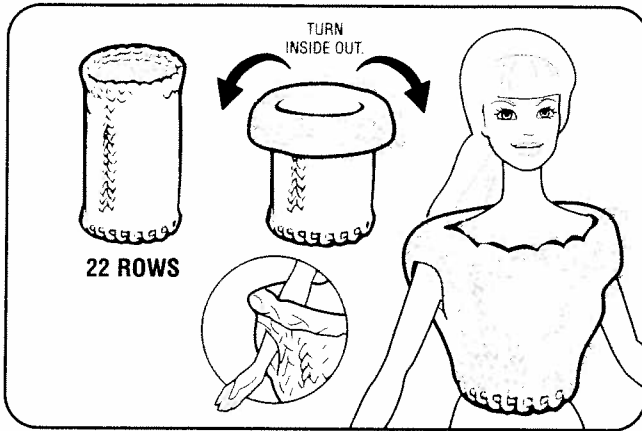

# Purse With Wrapped Glitter Yarn

*Doll not included.*

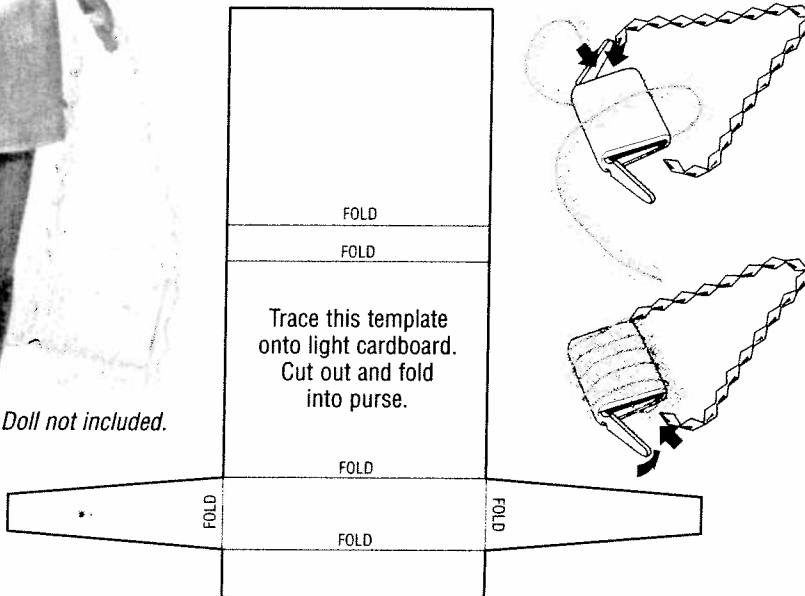

# Tube: Barbie® Doll Accessories

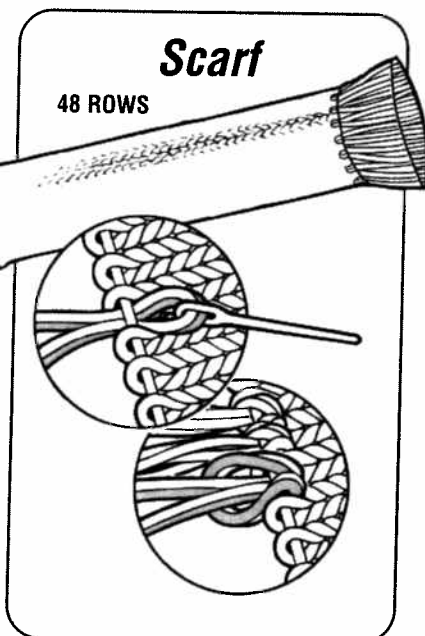
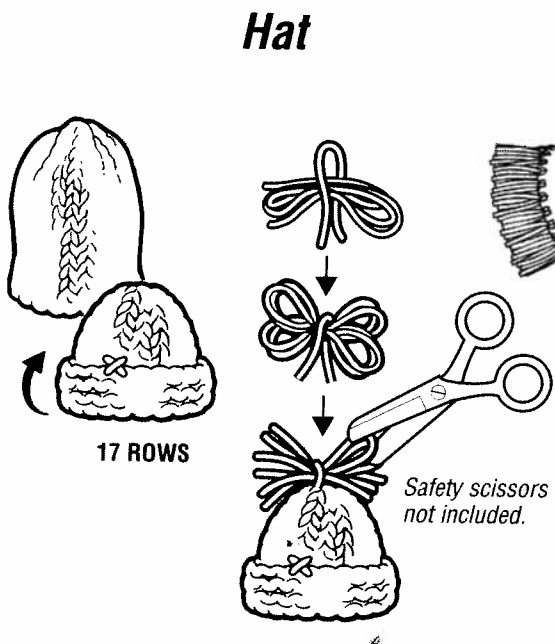
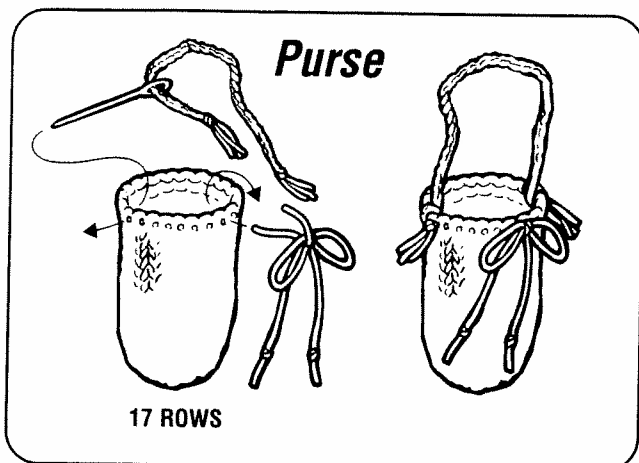

# Child Accessories

## Tube: Handbag

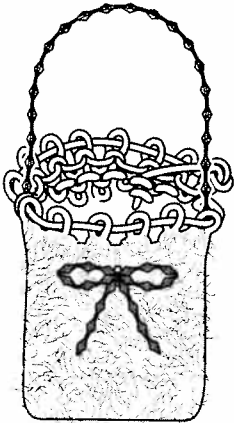
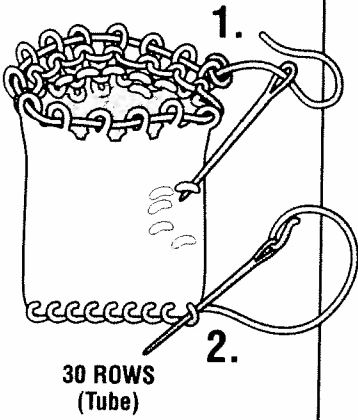

Turn handbag inside out.  
Use accent beads to make  
handle and bow.

## Tube: Hair Tie

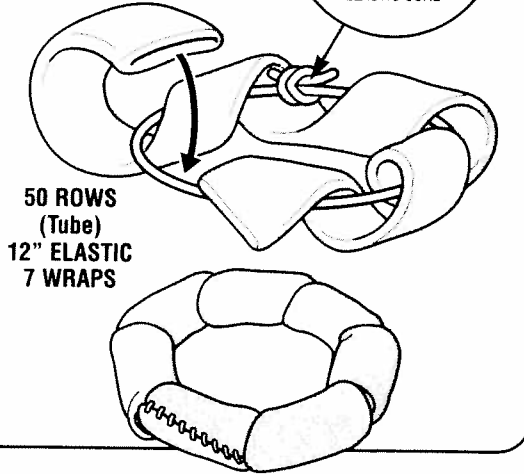

## Tube: Headband

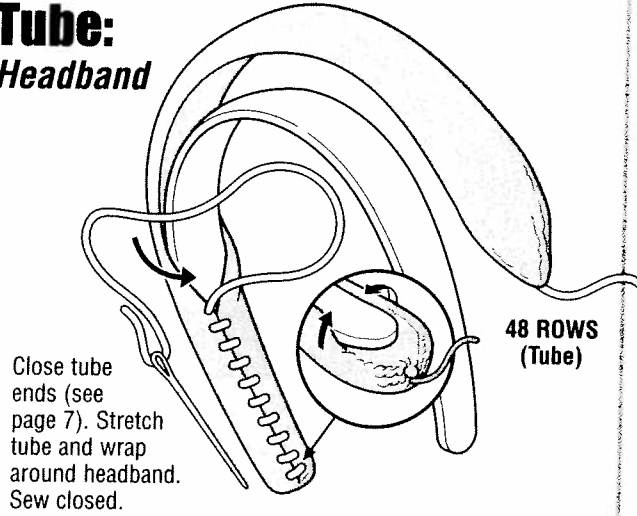

Close tube  
ends (see  
page 7). Stretch  
tube and wrap  
around headband.  
Sew closed.

# Crochet a Chain



## RIGHT HANDED

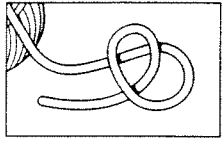

1. Place yarn as shown.

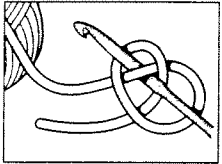

2. Insert crochet hook.

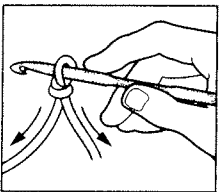

3. Pull yarn to make knot, but **not** too tight! the yarn should slide easily on the hook.

### How to hold the yarn.

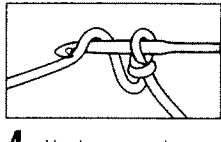
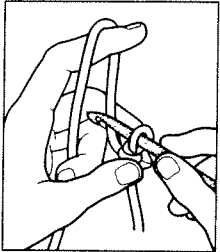

4. Hook yarn and ...

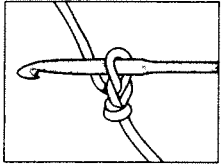

5. pull through loop.

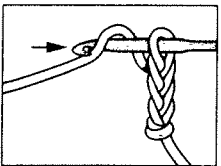

6. Continue pulling yarn through loops. Yarn must **always** go over the crochet hook from back to front.

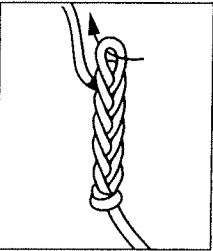

7. To finish, cut 4" length and bring through last loop. Tighten!

## LEFT HANDED

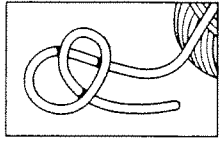

1. Place yarn as shown.

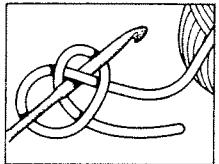

2. Insert crochet hook.

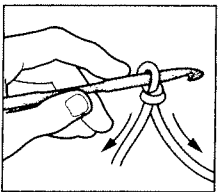

3. Pull yarn to make knot, but **not** too tight! the yarn should slide easily on the hook.

### How to hold the yarn.

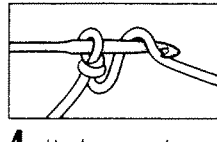
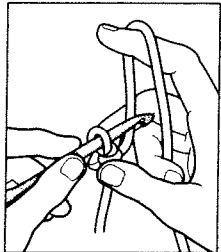

4. Hook yarn and ...

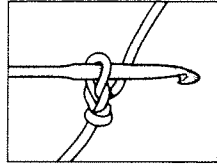

5. pull through loop.

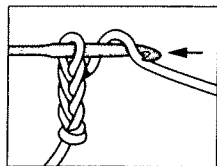

6. Continue pulling yarn through loops. Yarn must **always** go over the crochet hook from back to front.

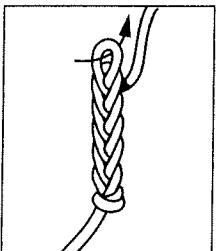

7. To finish, cut 4" length and bring through last loop. Tighten!

# Troubleshooting

If a stitch is dropped, use  
crochet hook to lift over  
machine hook.

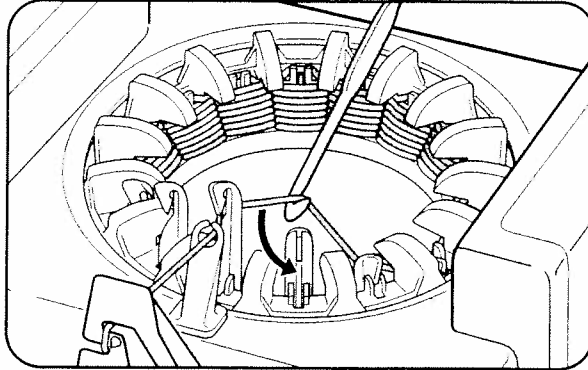

If a dropped stitch is woven  
into a tube or panel, simply  
unravel past the dropped  
stitch.

**NOTE:** Panels and tubes can  
be completely unraveled and  
yarn wound back onto skein  
for re-use.

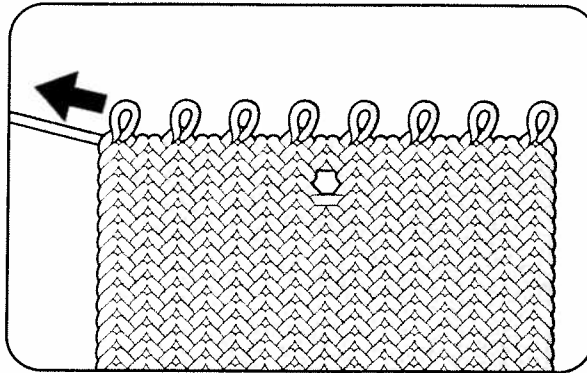

If tangles occur and  
cannot be undone, cut  
yarn with safety scissors  
(not included) and tie.  
Continue knitting.

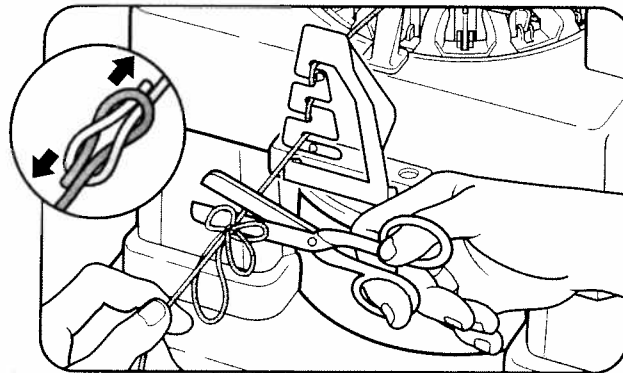

**CREATE A CUSTOM ACCESSORY FOR YOUR DOLL!**



*Dolls not included.*

**WARNING:**  
**CHOKING HAZARD** - Small parts.  
Not for children under 3 years.

**TWO YEAR LIMITED WARRANTY**

Mattel, Inc. warrants to the original consumer purchaser that this product will be free of defects in material or workmanship for two years (unless specified in alternate warranties) from the date of purchase. If defective, return the product along with proof of the date of purchase, postage prepaid, to Consumer Adjustment Center, 15930 E. Valley Boulevard, City of Industry, California 91744 for replacement or refund at our option. This warranty does not cover damage resulting from accident, misuse or abuse. **VALID ONLY IN U.S.A.** This warranty gives you specific legal rights and you may also have other rights which vary from state to state.

**CONSUMER INFORMATION**

YOU CAN TELL IT'S MATTEL! CALL us toll-free or write with any comments or questions about our products or service. Monday-Thursday: 8:00 a.m.-5:00 p.m. PST, 11:00 a.m.-4:00 p.m. EST. Friday: 8:00 a.m.-12:30 p.m. PST, 11:00 a.m.-3:30 p.m. EST. Outside U.S.A., see telephone directory for number listing. Consumer Affairs, Mattel, Inc., 333 Continental Blvd., El Segundo, CA 90245, U.S.A.

**1 (800) 524-TOYS**

**CE** CONFORMS TO THE SAFETY REQUIREMENTS OF ASTM F963.

**We are dedicated to quality products.**

Send only the product to the address above. Send all correspondence to Consumer Affairs, Mattel, Inc., 333 Continental Blvd., El Segundo, CA 90245-5012, U.S.A. Or you may phone us toll-free at 1-800-524-TOYS, Monday through Thursday: 8:00 a.m.-5:00 p.m. PST (11:00 a.m.-8:00 p.m. EST); Friday: 8:00 a.m.-12:30 p.m. PST (11:00 a.m.-3:30 p.m. EST).

