

LK100

INSTRUCTION BOOK

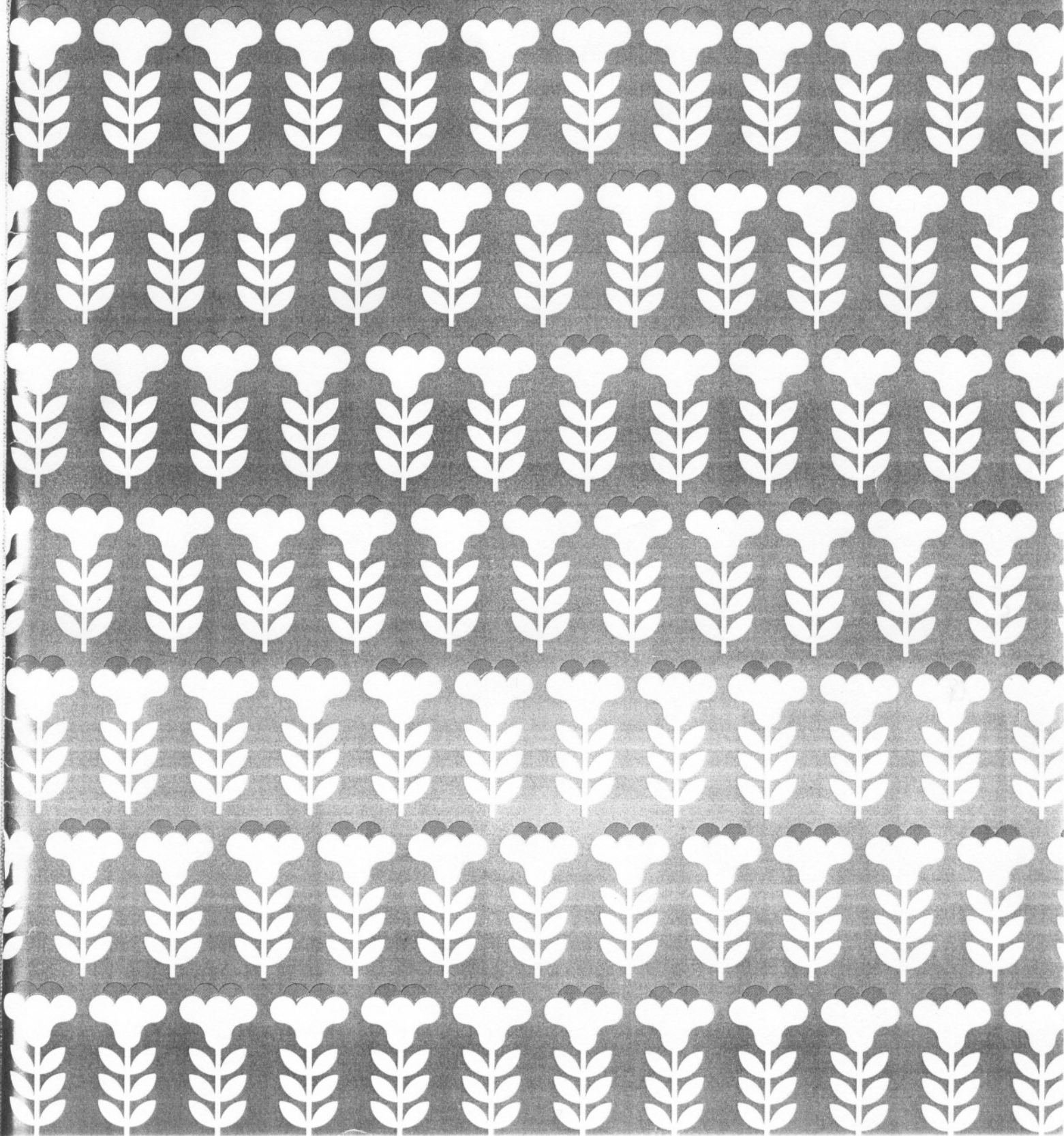

Knitting Procedure

- ① Select a garment from these pictures.
It is advisable to knit "Lady's Pullover" as a first try, as the pullover required most of basic techniques.
- ② Prepare the pattern paper and instruction leaflet for the selected garment.
This book contains the instruction of "Lady's Pullover".
- ③ Prepare the yarn and others following "Materials" on top left of each instruction.
- ④ Select your size, if necessary, following "Finished Measurements" on top right of each instruction.
- ⑤ Set up the machine following this instruction book.
- ⑥ Take a tension gauge following this book.
- ⑦ Calculate the stitches and rows on selected size of the selected pattern following this book.
- ⑧ Knit a garment following each instruction.

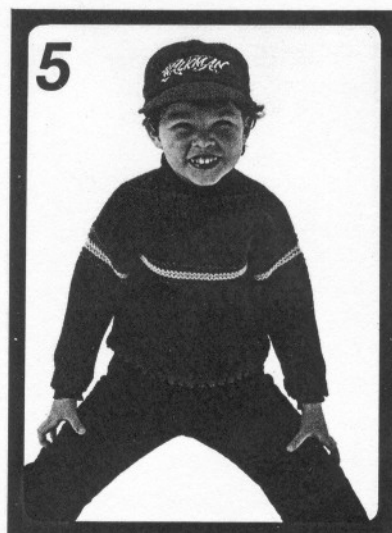
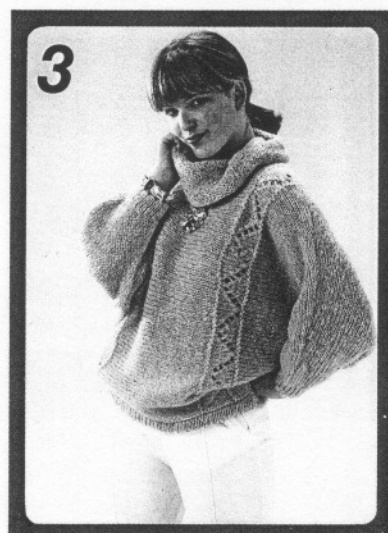

1. Lady's Pullover
2. Lady's Vest
3. Dolman Sleeve Sweater
4. Raglan Sleeve Cardigan
5. Child's Pullover
6. Child's Cardigan



CONTENTS

HOW TO SET UP THE MACHINE	1
NAMES AND FUNCTIONS OF EACH PART	2
How to remove Carriage from Needle Bed	3
How to replace Carriage on Needle Bed	3
Needle positions	4
Yarn and Stitch Dial	4
ACCESSORIES	5
TAKING A TENSION GAUGE	
Knit a Tension Swatch	6
How to obtain a tension gauge	11
CALCULATE THE NUMBER OF STITCHES AND ROWS	
Select two Knitting Scales	12
How to calculate the number of stitches and rows	12
1 Lady's Pullover	16
How to increase the stitch with Transfer Tool	17
How to put yarn mark	18
How to decrease more than two stitches	20
How to decrease one stitch	20
How to remove waste knitting	22
How to close the stitches (back stitch method)	24
How to work blind stitch	26
HELPFUL HINTS	
To pick up a dropped stitch	27
If a dropped stitch has run down for several rows	27
To unravel knitted fabric on the machine	28
If the Carriage has jammed	29
To replace a damaged needle	30
For successful knitting	30
MAINTENANCE	31

HOW TO SET UP THE MACHINE

Remove two Clamps, the Tension Spring and the Row Counter from the Box.
Turn Clamp Screws as far down as they go.

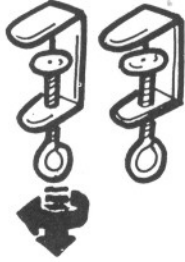

Clamps

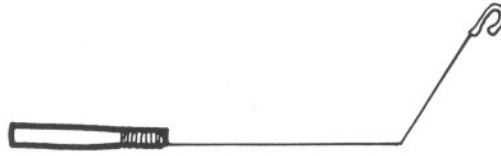

Tension Spring

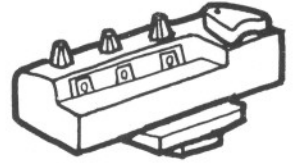

Row Counter

Place the Knitter on the table as shown below.
Insert the Clamps into the slots "A" at the bottom of
Needle Bed.

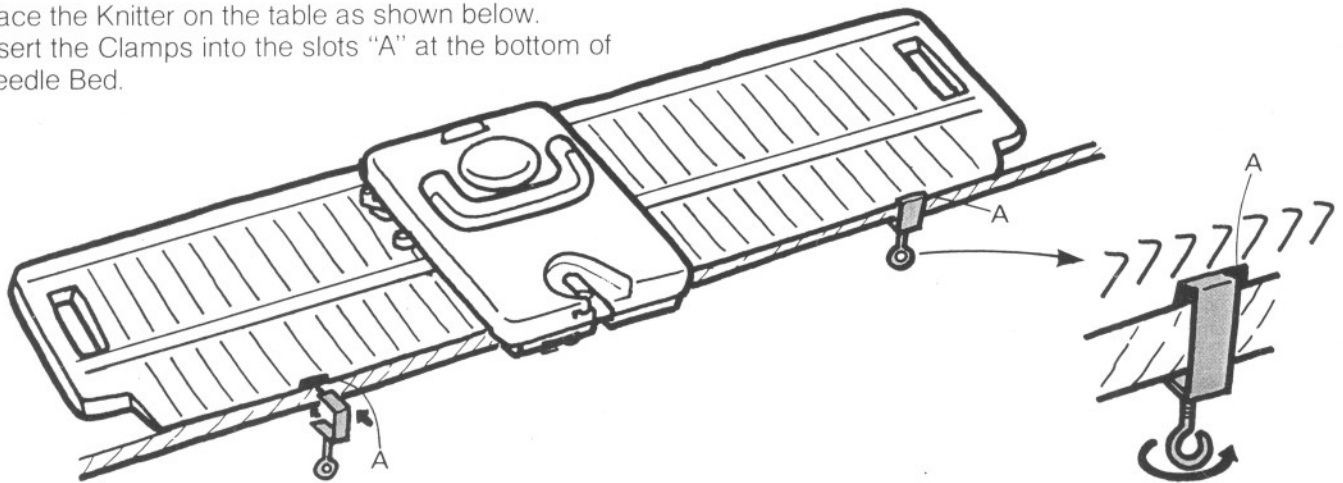

Fasten the Clamps by turning in the arrowed direction.

Align notch "B" with Groove "C" and insert Tension
Spring into Carriage.

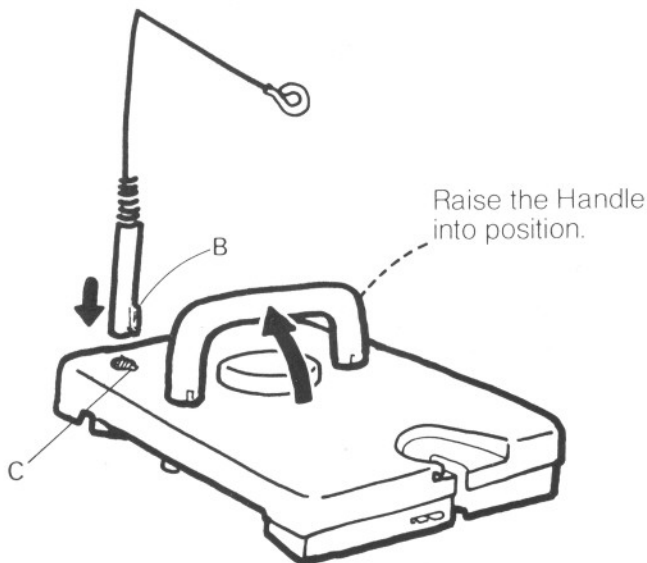

Insert the foot of Row Counter "D" into either slot "E"
at the back of the Needle Bed.

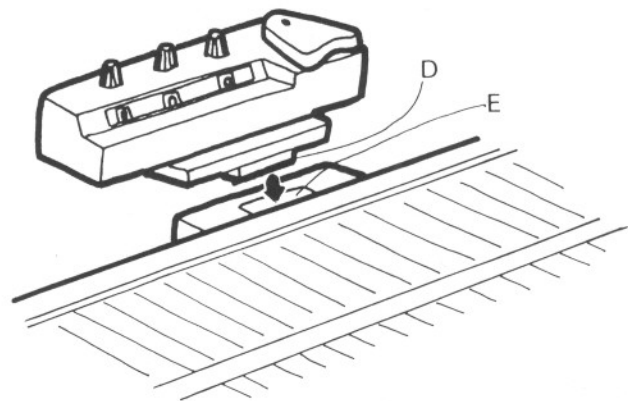

NAMES AND FUNCTIONS OF EACH PART

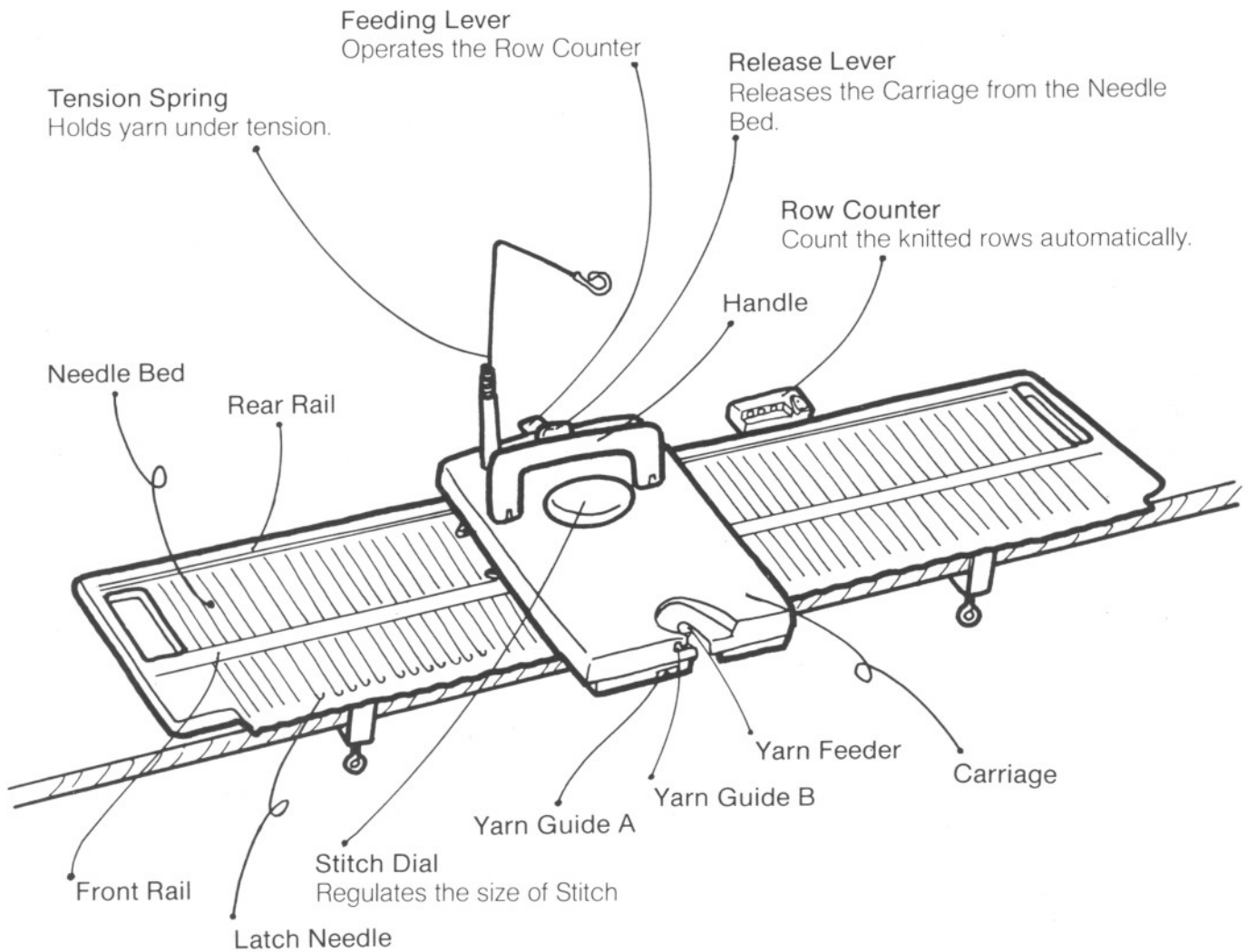

Latch Needle



- a. needle roller
Push the roller to place the needle in the correct position.
- b. latch
- c. hook

How to remove Carriage from Needle Bed

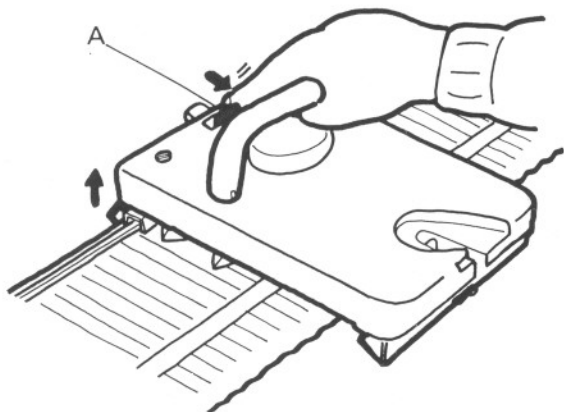

1. Pull forward the Release Lever "A" and lift up the back of Carriage.

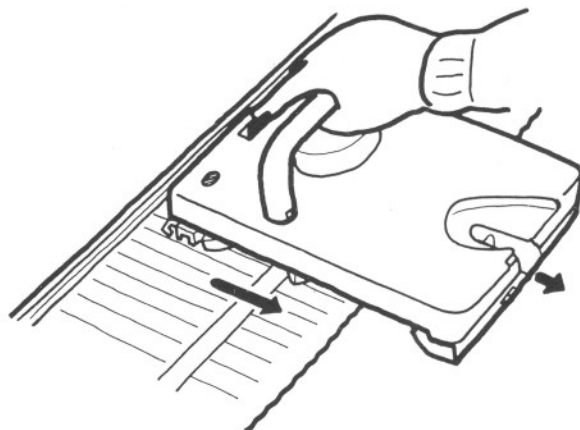

2. Move the Carriage forward.

How to replace Carriage on Needle Bed

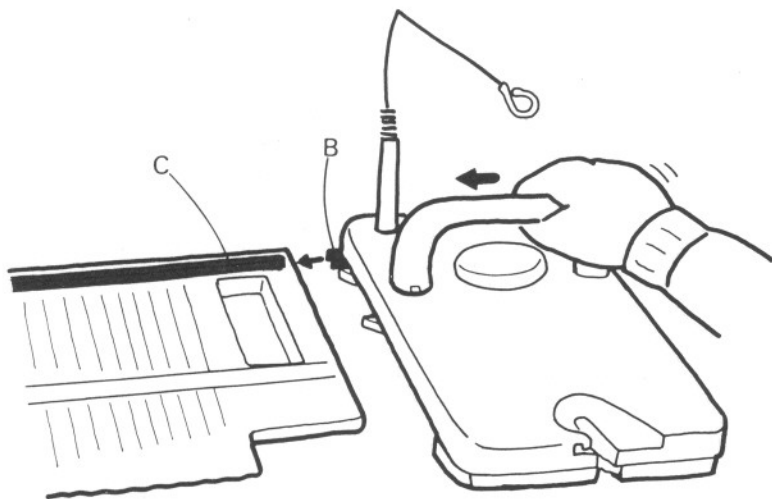

Method 1.

Fit the Carriage Groove "B" to the Rear Rail "C".
Slide Carriage horizontally along Needle Bed.

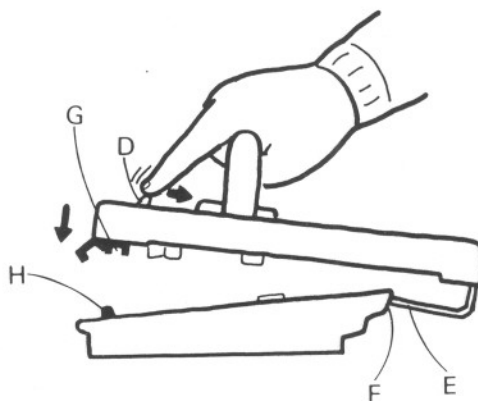

Method 2.

Align needles in A position.
Pulling forward Release Lever "D", fit the Fabric Presser "E" to Sinker Posts "F" and fit the Carriage Groove "G" to Rear Rail "H".

Make sure Carriage moves smoothly on Needle Bed.

Needle positions

The letters A, B, C and D at both ends of the Needle Bed show different needle positions. Each letter denotes a different functions for the needle.

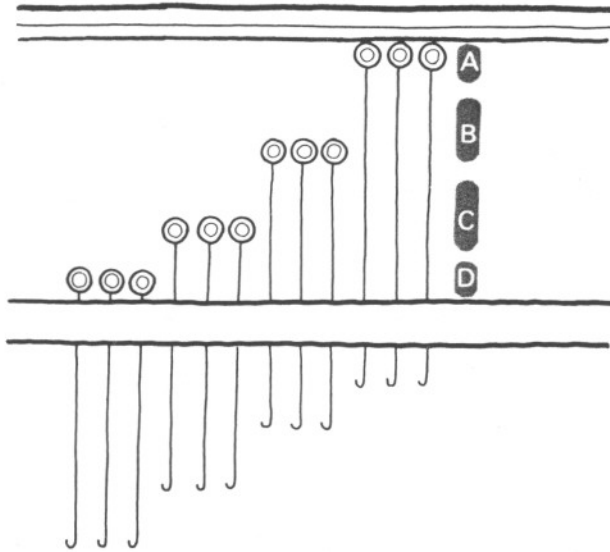

- A non-working position
- B knitting position
- C knitting position for rested needles
- D resting position for working needles

To operate the needles, position the needle rollers within the “0” mark.

Yarn and Stitch Dial

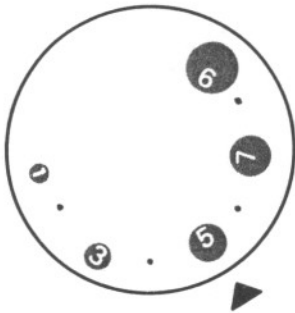

To obtain correct stitch size, or suitable tension for a garment, set the Stitch Dial Number according to the thickness of the yarn. The thicker the yarn, the higher the Stitch Dial Number, and the thinner the yarn, the lower the Stitch Dial Number.

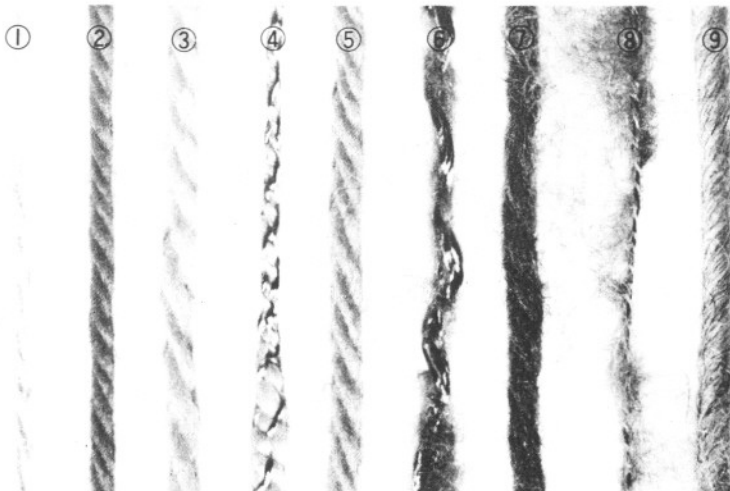

Type of yarns	Stitch Dial
① ~ ③ thick yarn	1 ~ 3
④ ~ ⑤ very thick yarn	4 ~ 5
⑥ ~ ⑦ extra thick yarn	6 ~ 7
⑧ ~ ⑨ super extra thick yarn	8 ~ 9

ACCESSORIES

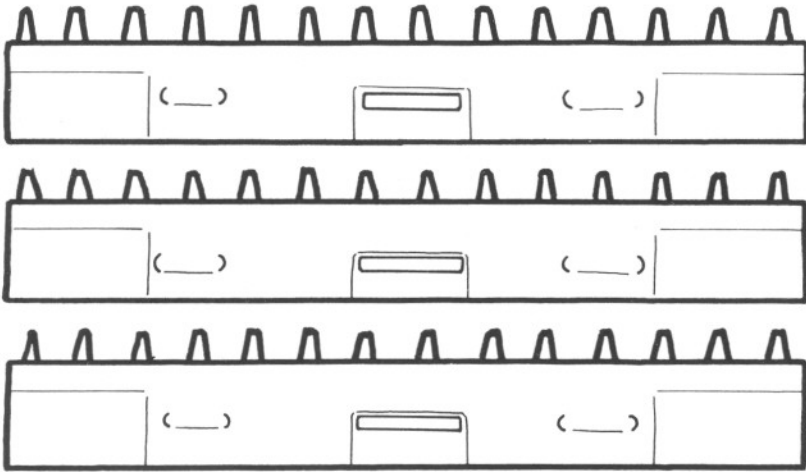

Cast-on Comb (3 pcs.)

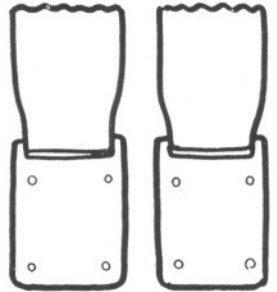

Claw Weight (2 pcs.)



Needle Pusher



Oil

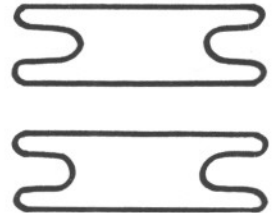

Comb Connector (2 pcs.)

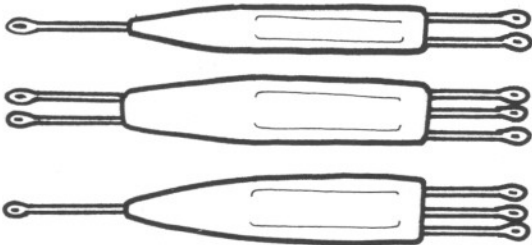

Transfer Tool 1—2
2—3
1—3 (1 pc. each)



Tapestry Needle



Tappet Tool



Pattern Paper & Instruction leaflet
(half size)

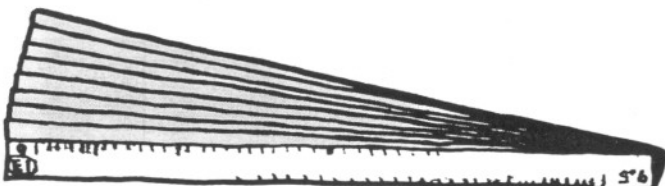

Knitting Scale (E1 — E9)

TAKING A TENSION GAUGE

Tension Gauge indicates how many stitches you need to cast-on, and how many rows you need to knit a 10cms. square.

It is very important to take a correct tension gauge to ensure that your garment is the correct size.

Knit a Tension Swatch

To take a correct tension gauge, the tension swatch must be knitted in the same stitch pattern, with the same yarn and Stitch Dial number as to be used for a garment.

1. Prepare yarn.

Prepare the same yarn as for the garment.

It is impossible to knit from a hank of yarn or hand wound ball, so unwind them into a basket or a box.

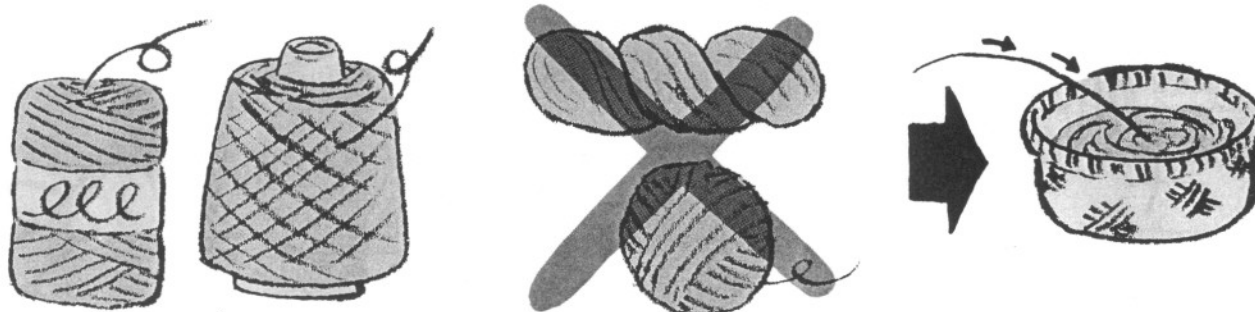

2. Arrange needles.

Place Carriage on the left side of the Needle Bed.

Push 15 needles on both sides of the centre "0" to B position (30 needles altogether) using straight side of Needle Pusher.

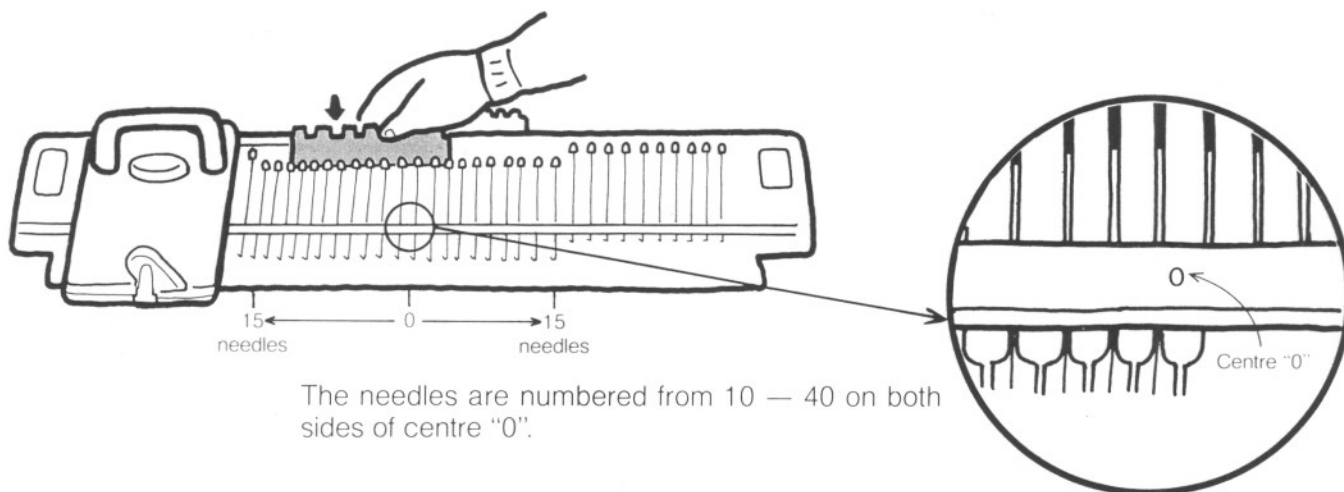

The needles are numbered from 10 — 40 on both sides of centre "0".

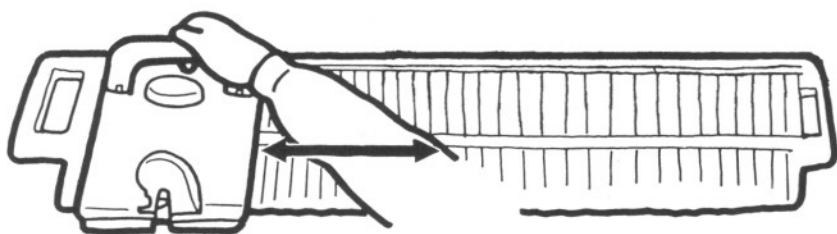

Move the Carriage to the right until it passes all the needles in B position then return it to the left.

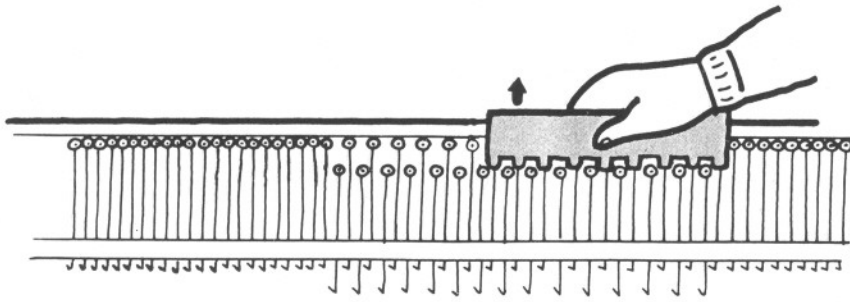

Using 1 × 1 side of Needle Pusher, push every other needle in B position back to A position.

3. Thread yarn.

Set the Stitch Dial referring to page 4.

Place the yarn on the floor in front of the machine and thread it through Carriage in the following manner.

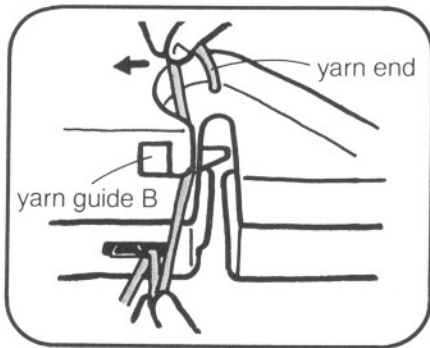

2

Slide the yarn to the left into Yarn Guide B.

3

Click the yarn into Tension Spring eyelet.

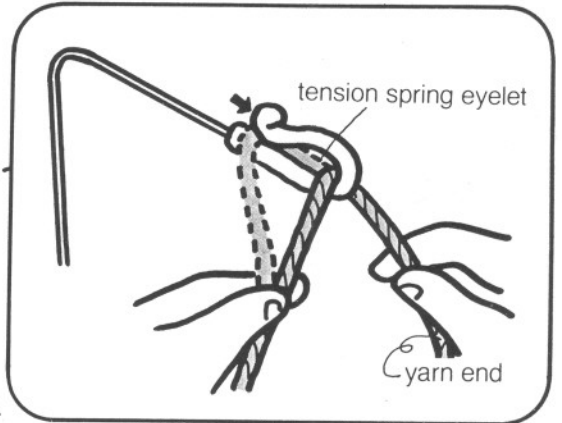

1

Hold the yarn end above Yarn Guide A. Hold the yarn running from the ball below the guide. Slide the yarn from the left side and click it into the eyelet of the Yarn Guide A.

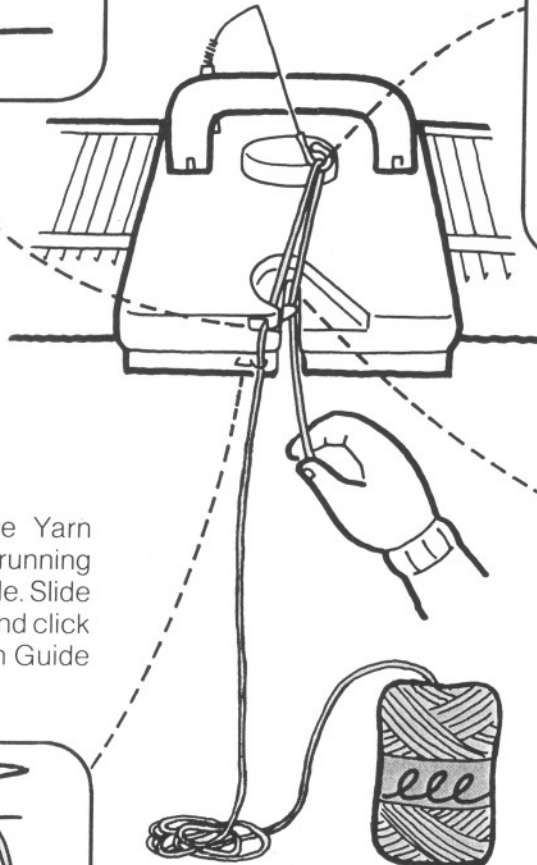
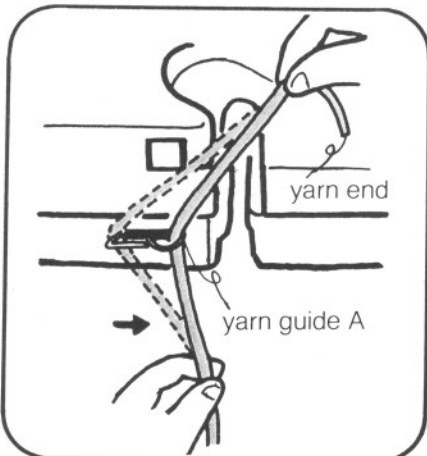

4

Slide the yarn right back into Yarn Feeder.

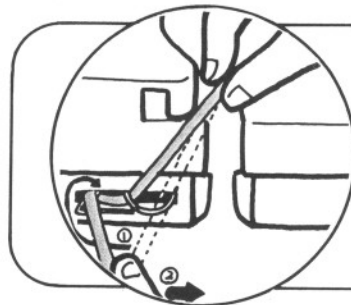
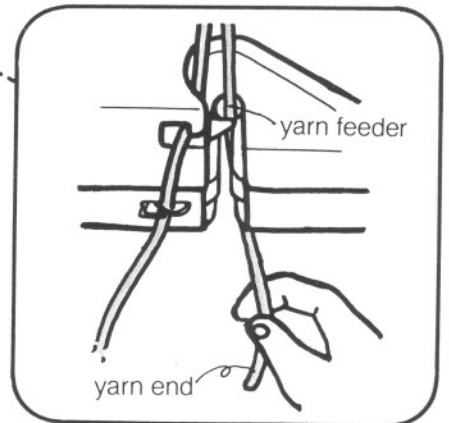

How to remove the yarn from Yarn Guide A.

Hold the yarn as shown opposite. Bring the yarn from behind Yarn Guide and slide it to the right.

4. Knit 1 row.

Holding yarn end underneath Yarn Feeder with your right hand, eliminate slack yarn by pulling yarn under Yarn Guide A.

Move the Carriage from the left to the right.

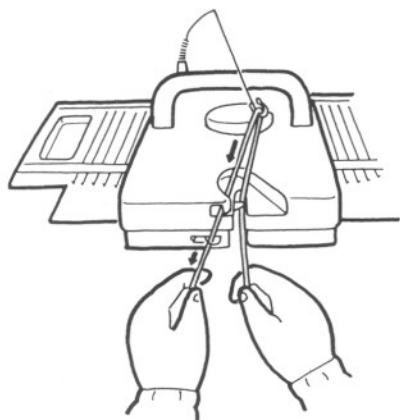

It is advisable to pull out a length of yarn from the yarn ball.

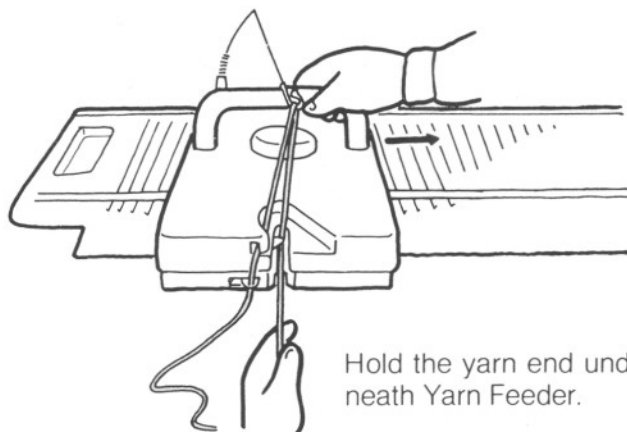

Hold the yarn end underneath Yarn Feeder.

5. Hook Cast-on Comb on sinker loops as shown.

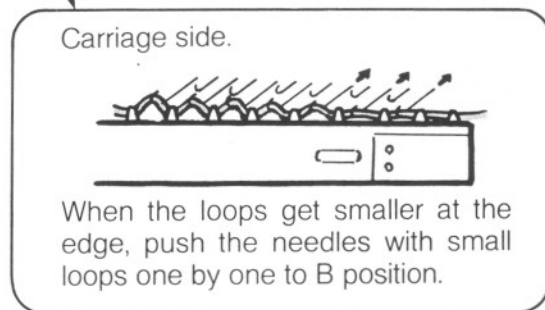
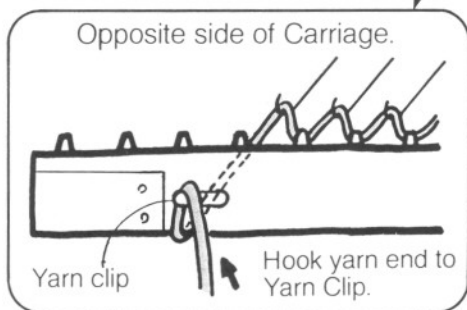
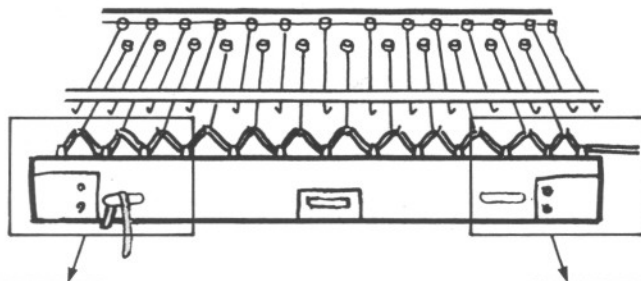

What to do when using a lot of needles

Join Cast-on Combs with Comb Connector according to the width of the knitting.

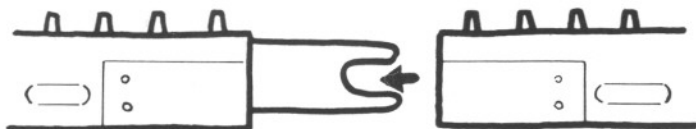

Insert one end of Connector into slot on the side edge of a Comb and join another Comb in the same manner. Hang the Comb so that it is balanced horizontally between working needles.

At Carriage side, unhook this length of yarn from comb.

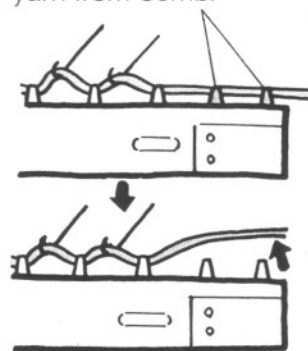

6. Knit a tension switch.

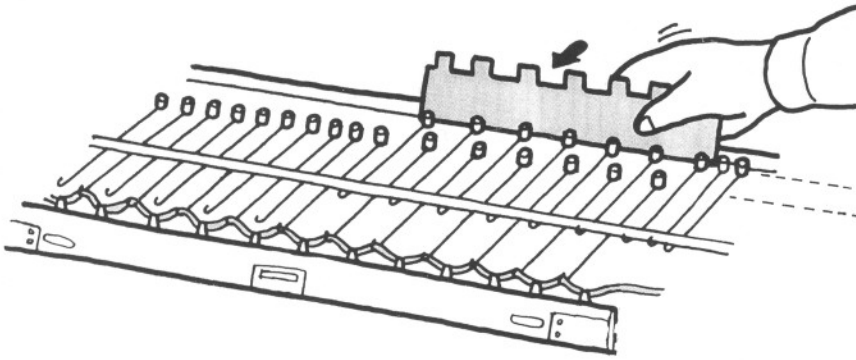

Return needles in A position to B position, using plain side of a Needle Pusher.

A — Non-working position
B — Working position

Set Row Counter to 000 by turning dial.

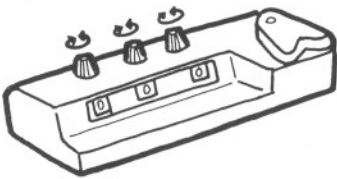

Row Counter will also fit on this side of Needle Bed.

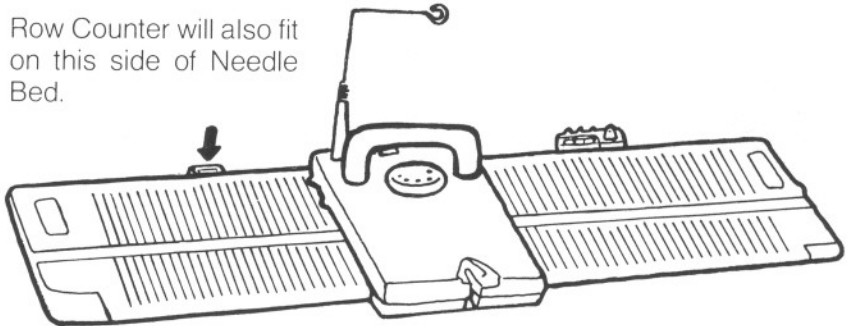

Knit 3 rows at an even speed ensuring the Carriage has passed the last knitted needle by approximately 3 — 4cm. before knitting next row.

Hang Claw Weights on both edges of fabric.

Continue to knit until Row Counter shows 040.

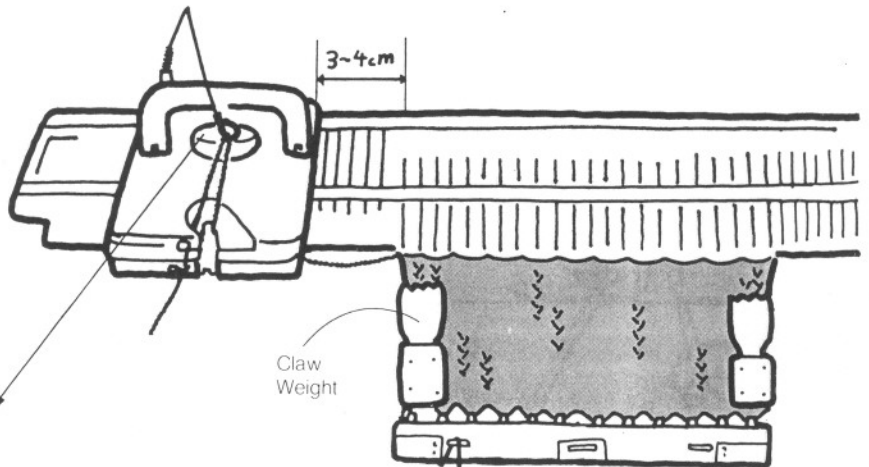

MAKE A NOTE OF THE STITCH DIAL NUMBER.

CAUTION

*If the Carriage jams see page 29.
Do not push the Carriage by force.
Do not lift the Carriage while knitting.*

When you knit a garment, move the Combs and Weights up every 20 rows as shown.

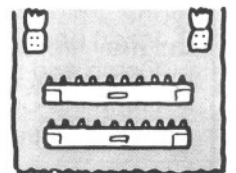

7. Remove the fabric from machine.

Remove Cast-on Comb and Claw Weights from the fabric. Remove the yarn from Carriage and cut the yarn end.

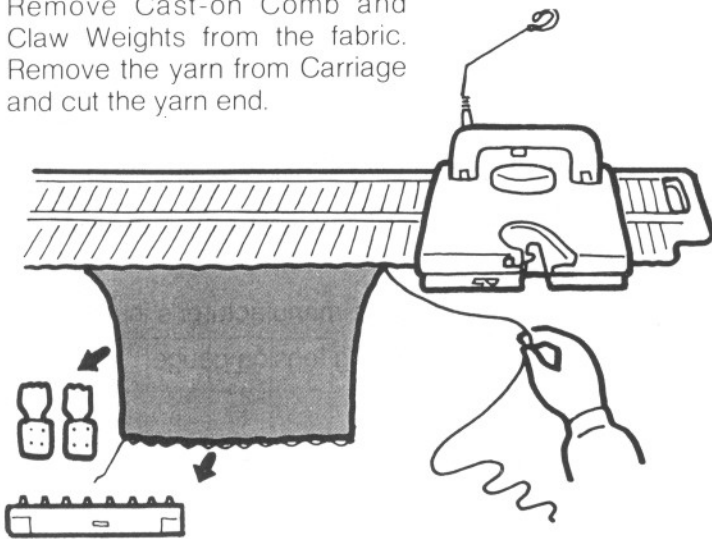

Holding the fabric, move Carriage once. The fabric will be removed from the Needles.

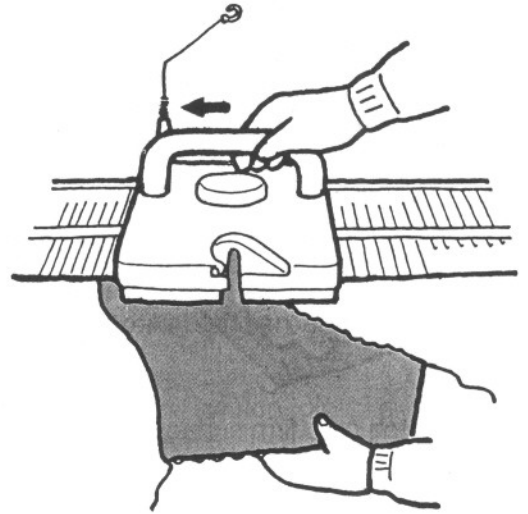

What to do when the yarn is running out.

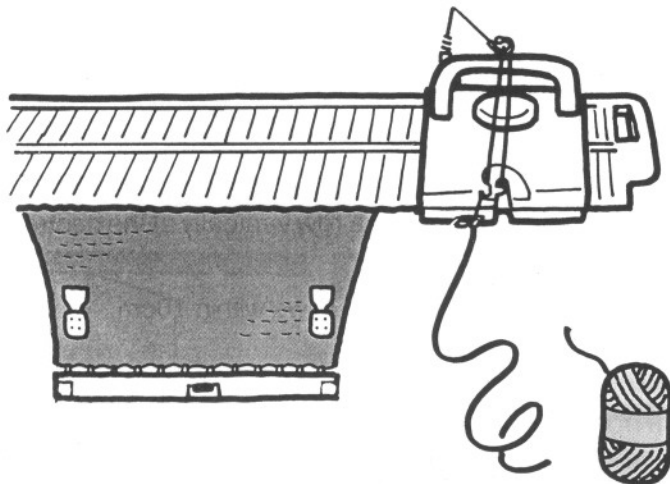

If there isn't enough yarn to complete a row, remove the yarn from the Carriage and hook the end to a Yarn Clip.

Thread new yarn through the Carriage and knit 1 row.

Tie two yarn ends loosely at the edge and continue to knit.

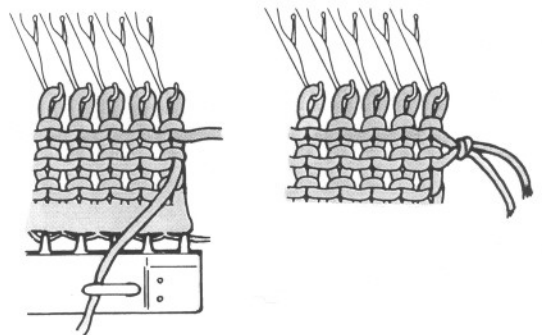

If the yarn is more than 3 times the width of knitting, you can knit another row.

If there is a knot in the yarn, untie or cut at this point and work in the same manner as above.

Do not knit knots.

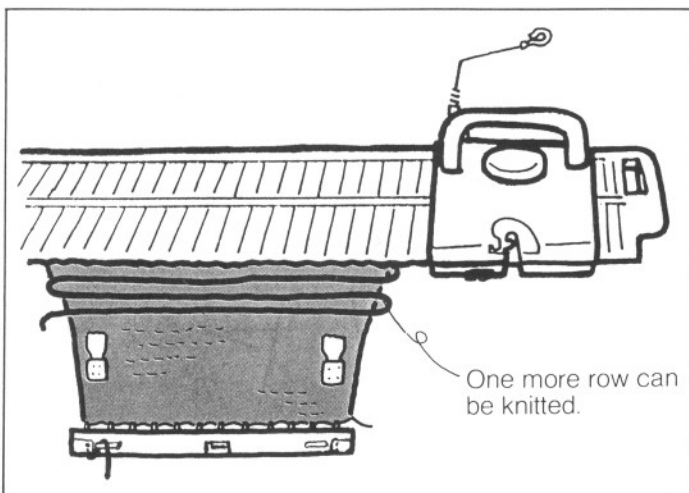

How to obtain a tension gauge

By measuring a tension swatch, you can obtain a tension gauge.
Measure a swatch correctly as follows.



Roll the swatch into a tube from side to side, and pull to close the stitches up.

Allow the swatch to rest for several hours, to return to its natural condition after being stretched on the machine.

Press according to yarn manufacturer's instructions.

Allow to dry before taking tension gauge.

Place the swatch on a firm surface so that it lies flat without distortion.

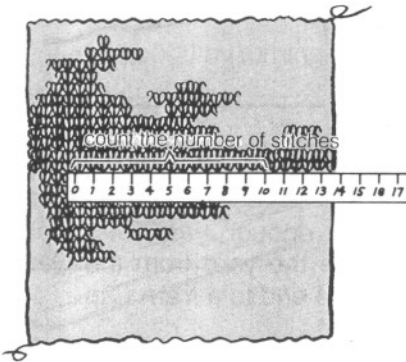

Place a ruler along stitches on the same row at the centre of the swatch.

Count the number of stitches within 10cm.

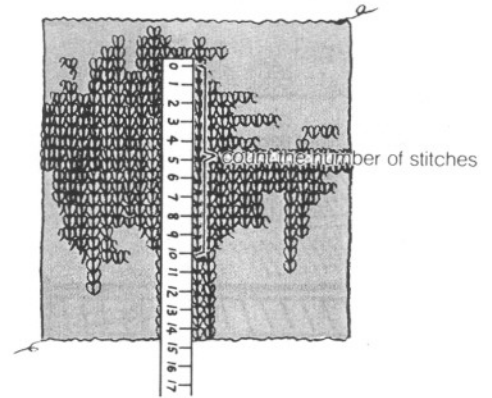

Place a ruler down a row vertically at the centre of the swatch.

Count the number of rows within 10cm.

These numbers are called TENSION GAUGE. Make a note of them, together with the Stitch Dial number.



CALCULATE THE NUMBER OF STITCHES AND ROWS

Select two Knitting Scales

The Knitting Scales are marked to represent stitches or rows required to knit 10cms. Each mark on the Knitting Scale represents $\frac{1}{2}$ stitches or $\frac{1}{2}$ rows of their actual size. Therefore, half scale patterns should be used. If the shaping is the same at both sides, only half the pattern is required.

Nine Knitting Scales are provided, covering 36 gauges in all, from 9 to 30. These are shown in the table below.

Scale No.	E1	E2	E3	E4	E5	E6	E7	E8	E9
Range of stitches/ rows	9	11	13	15	17	19	21	23	27
	9.5	11.5	13.5	15.5	17.5	19.5	21.5	24	28
	10	12	14	16	18	20	22	25	29
	10.5	12.5	14.5	16.5	18.5	20.5	22.5	26	30

Before beginning to knit a garment, a tension gauge of the knitting should be taken, and the correct Knitting Scales selected.

e.g. If the tension swatch gives a reading of 15 stitches for 10cms., use the Knitting Scale with 15 at the left end.

If the tension swatch gives a reading of 23.5 rows for 10cms., use the Knitting Scale with 24 at the left end.

How to calculate the number of stitches and rows

On the pattern, horizontal lines represent stitches, and vertical lines represent rows. Slanting lines represent increasing or decreasing stitches and rows.

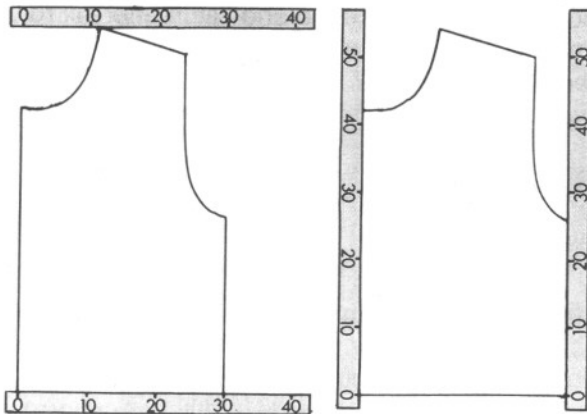

Horizontal and Vertical lines

Place the selected Knitting Scale on a pattern reduced to half scale, and read stitches and rows.

To measure horizontal lines, use the Knitting Scale with the same number as the reading for the stitches on the tension swatch.

To measure vertical lines, use the Knitting Scale with the same number as the reading for the rows on the tension swatch.

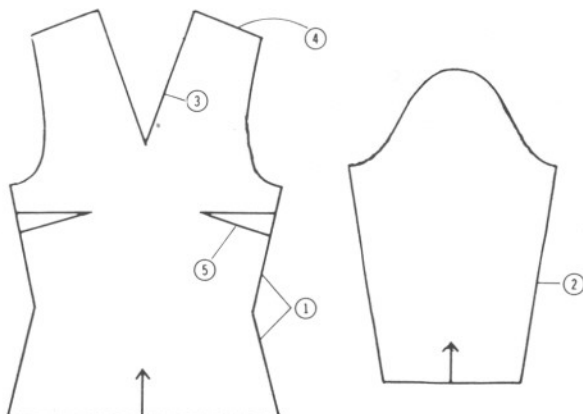

Along a Slanting line

Slanting lines can be steep or gentle ones. The side ①, under arm ②, and V-neckline ③ are the former, and the shoulder slope ④ and side dart ⑤ are the latter.

Calculation of stitches and rows along steeply slanting lines

Stitches must be increased or decreased by one after knitting a given number of rows. To determine the rate of increase or decrease, the total rows should be divided by the total stitches in a particular section. However, you cannot increase or decrease the number of stitches immediately after starting knitting or at the point the knitting ends. Therefore, add one (1) to the number of stitches before calculation.

(Example)

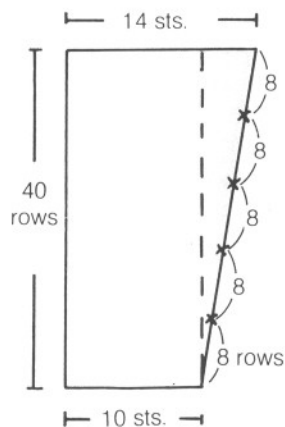

Total increments: 4 stitches over 40 rows.
Therefore: Divide 40 by $(4 + 1) = 8$ rows.

(How to increase stitches)

Increase one stitch after eight rows of knitting. Repeat this process four times in total. Thereafter, knit eight rows without increasing or decreasing stitches.

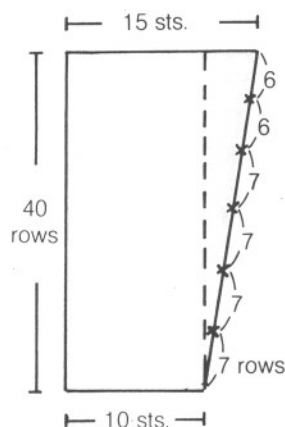

* If the rows are not divisible by stitches, the remainder should be allocated in the following manner.

Total increments: 5 stitches over 40 rows.

Therefore: Divide 40 by $(5 + 1) = 6$ rows and 4 rows (remainder)

(How to allocate the remainder)

To distribute the four rows, increase stitches by one after every seven rows of knitting. Repeat this process four times, then increase one stitch after six rows of knitting, and knit six rows without increase or decrease in stitches.

Calculation of stitches and rows along gently slanting lines

In this instance, more stitches must be increased or decreased than the total number of rows knitted. Every row or every two rows must be increased or decreased by some stitches. The rate of increase or decrease is calculated by dividing the total number of stitches to be increased or decreased by the total number of rows to knit.

Use the partial knitting technique (Holding position) for this. i.e. increase or decrease several stitches every row, or every two rows. Calculate this as follows.

Since partial knitting occurs every two rows the number of rows to be knitted is divided by two,

(Example)

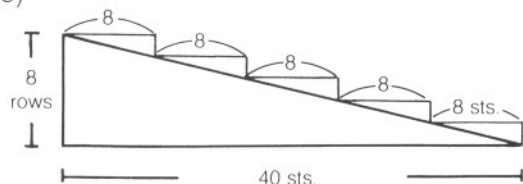

Rows to knit: 8 rows

Partial knitting: $8 \text{ rows} \div 2 = 4$ (times)

$40 \text{ stitches} \div (4 \text{ times} + 1) = 8 \text{ stitches}$

(How to decrease stitches)

Decrease stitches by eight every two rows, using partial knitting. Repeat this process four times. Eight stitches remain.

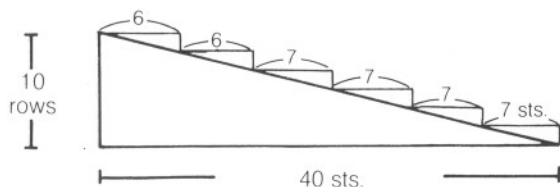

* If the stitches are not divisible by the times of partial knitting plus one, the remainder should be allocated in the following manner.

$$40 \text{ stitches} \div (5 \text{ times} + 1) \\ = 6 \text{ stitches and } 4 \text{ stitches (remainder)}$$

(How to allocate the remainder)
Decrease seven stitches every two rows. Repeat this process four times, then decrease six stitches once, six stitches remain.

Calculation of stitches and rows along curved lines

An accurate and convenient method of determining the number of stitches and rows is to use a graph with the same rulings as the gauge of the knits (knitting graph). Draw a curve on the graph paper, and read the coordinates of the curve.

Preparing a knitting graph

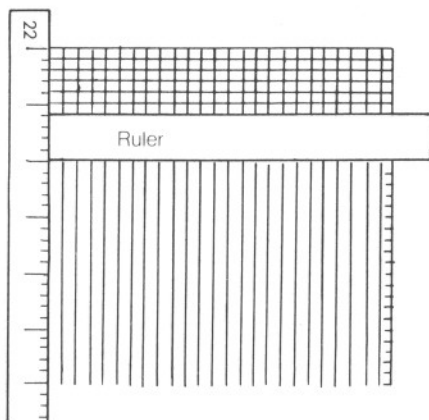
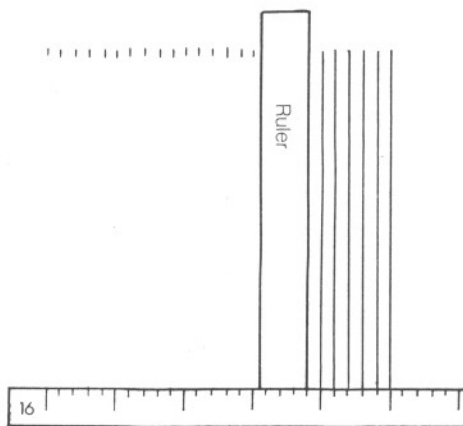

1. Collect a sheet of paper large enough to draw the graph on, the correct Knitting Scales indicated by the measurement of the tension swatch, and tracing paper.
2. Select the Knitting Scales with the same gauge number as the tension swatch. When the tension swatch has a gauge of 16 stitches \times 22 rows, the No.16 and No.22 Knitting Scales should be used. The No.16 scale should be used to draw vertical lines (stitches) and No.22 scale for horizontal lines (rows).
3. Using the Knitting Scales, draw vertical lines and horizontal lines on the sheet of paper.
The graph paper must be large enough to cover all the curved sections of half size patterns (armhole, neckline, sleeve, etc.)

Reading increases or decreases along curved lines

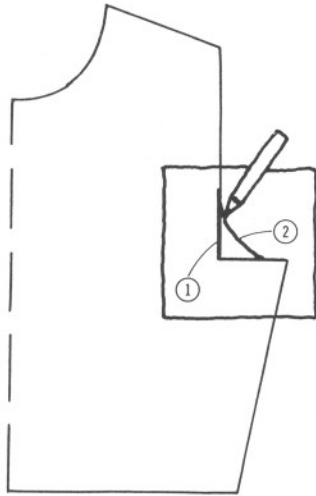

1. Draw a right-angled triangle ① whose oblique side ② starts and finishes at the curved section of the pattern. Overlay tracing paper on the pattern, and trace the curved section on the tracing paper.

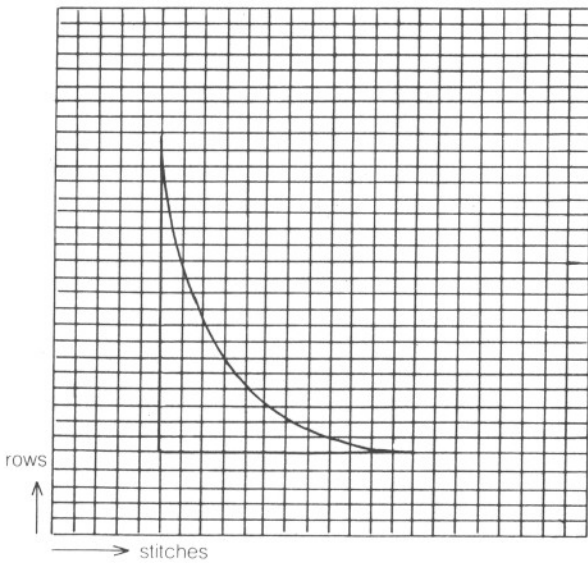

2. Place the tracing paper on the knitting graph paper, aligning the vertical side and the horizontal side of the triangle with horizontal and vertical lines of the graph paper respectively.

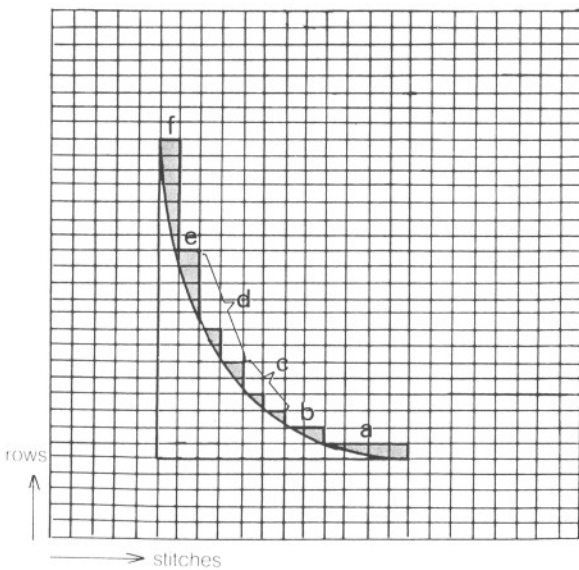

3. Divide the curve into steps as shown on the graph to read increases or decreases of stitches and rows.

(How to decrease stitches)

- a. Decrease four, knit 1.
- b. Decrease 2, knit 1.
- c. Decrease 1, knit 1, decrease 1, knit 2.
- d. Decrease 1, knit 2, decrease 1, knit 4.
- e. Decrease 1, knit 2.
- f. Decrease 1.

1 Lady's Pullover

Materials

Very thick yarn 450 — 550gs.
 Contrast coloured waste yarn 50gs.

Take a tension gauge from the tension swatch knitted in the same stitch with the same yarn and Stitch Dial as to be used for the garment.

Reference Tension Gauge

16 stitches by 18 rows over the swatch of Stockinet with the Stitch Dial at ⑤.

Select a size from the three sizes on the Pattern Paper.

Finished Measurements

size: cm.

	S	M	L
Bust	92	100	108
Length	59	60	61
Sleeve length	56	57	58

Calculate the number of stitches and rows for the selected pattern, according to the tension gauge.

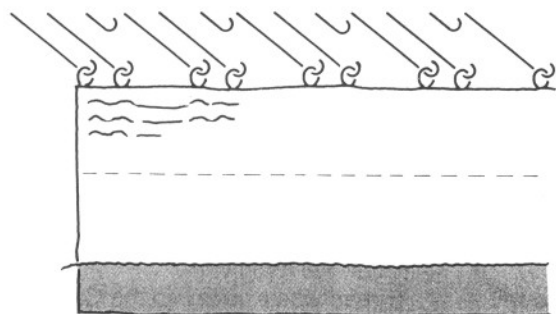
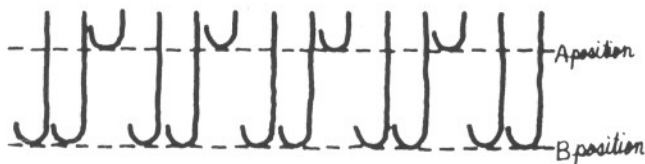
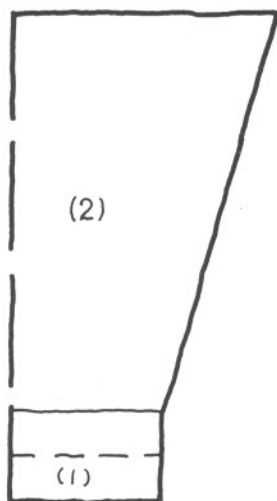

TO KNIT

Sleeve

- (1) Knitting the Cuff.
 - Push the required number of needles into B position for the width of the cuff.
 - Push back every other needle to A position, using Needle Pusher.
 - Thread waste yarn (different colour yarn from the main colour) through the Carriage and into the Yarn Feeder.
 - Knit 1 row and hang Cast-on Combs.
 - Push the needles left in A position into B position.
 - Knit 5 rows with waste yarn.
 - Push every 3rd needle starting from 3rd needle from the edge to D position.
 - Push the same needles back to A position. The stitches on those needles will drop off. (2 needles left in B position, 1 in A position along width of knitting.)
- Knit 6 rows.
- Break the waste yarn.
- Thread the main yarn through the Carriage.
- Set the Stitch Dial 2 numbers lower than the original number of the tension swatch i.e. If tension swatch was knitted at 5, set dial to 3.
- Holding the yarn end, knit the required number of rows for the cuff.

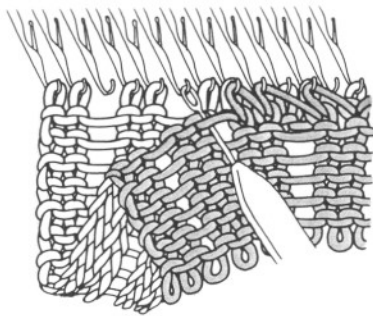
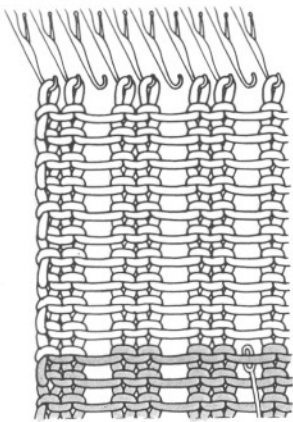

- Return the needles that were pushed back to A position to B position.
- Pick up the sinker loops from the first row of the main knitting and place them onto the corresponding needles in B position.
- Reset the Stitch Dial to the original number of the tension switch.

How to increase the stitch with Transfer Tool

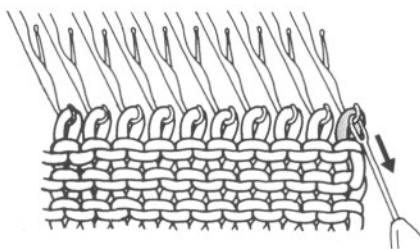

Place the eye of the Transfer Tool on the hook of the last needle in B position, and pull forward holding the side of the fabric by hand downward.

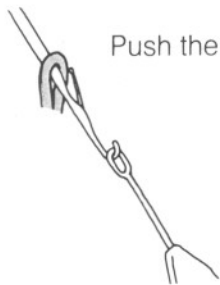

Push the needle back.

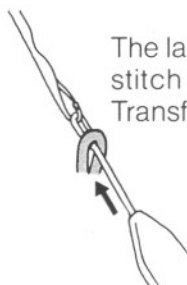

The latch closes, and the stitch moves onto the Transfer Tool.

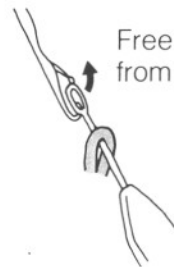

Free the Transfer Tool from the needle hook.

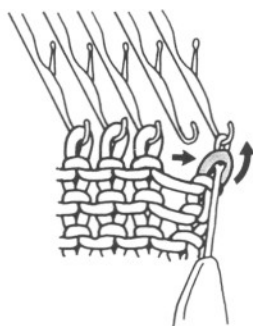

Place the Transfer Tool on the adjacent empty needle hook. Tilt the Transfer Tool upwards, so the stitch slides down into the needle hook.

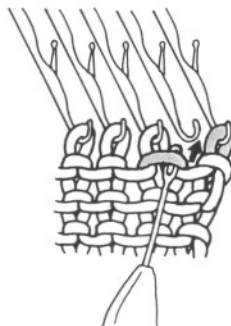

Pick up the loop below the second stitch and place it onto the empty needle as shown.

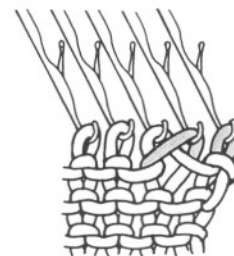

Continue to knit. 1 stitch is increased.

(2) Knitting the sleeve.

- Knit the required number of rows, increasing the stitches at both edges, according to your calculations.

- Complete the sleeve, according to your calculation.
- Break the main yarn.
- Thread waste yarn into the Carriage.
- Knit 6 rows and remove from the machine.
- Knit the other sleeve in the same way.

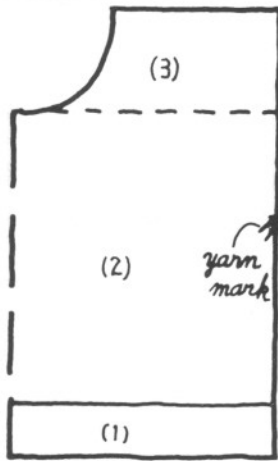

Front

- (1) Knitting the welt.
 - Push the required number of needles to B position for the width of the welt.
 - Work in the same manner as for the cuff of the sleeve in Step (1).
 - Reset the Stitch Dial to the original number of the tension switch.
- (2) Knitting front.
 - Continue to knit until the position of the sleeve.
 - Put yarn mark at the both side edges.

How to put yarn mark

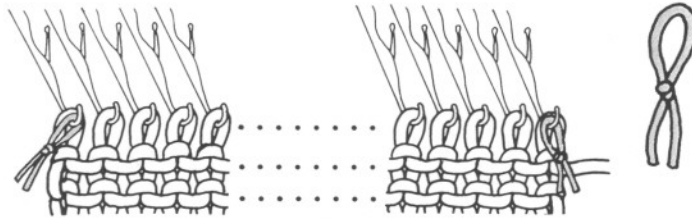

Place a piece of waste yarn on the needle that should be marked as shown.

- Knit the required number of rows until front neckline.

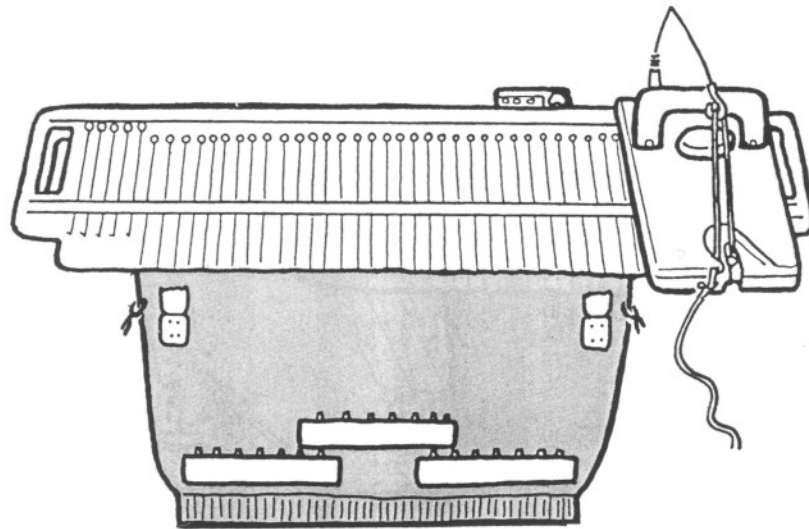

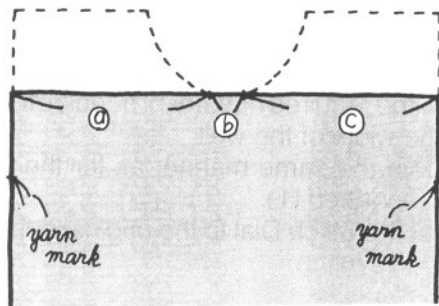

(3) Shaping front neckline.

- At the front neckline, divide into three sections, right, centre straight, and left.

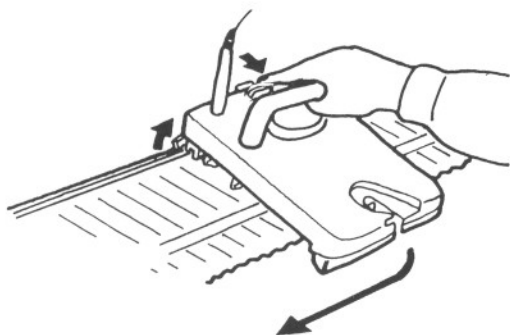

- Remove the main yarn from the Carriage.
- Pull forward the Release Lever and remove the Carriage from the Needle Bed.
- Replace the Carriage on the opposite side to its original position.

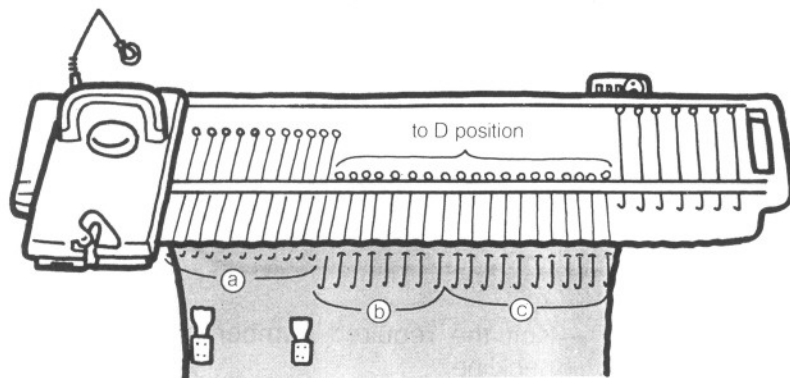

In case the Carriage was on the right side:

- Replace the Carriage on the left.
- Push the needles of (b) and (c) sections to D position.
- Hang the claw weights at both edges of (a) section.
- Thread waste yarn into the Carriage.
- Knit 6 rows.
- Remove (a) section from the machine.
- Push back the empty needles to A position.

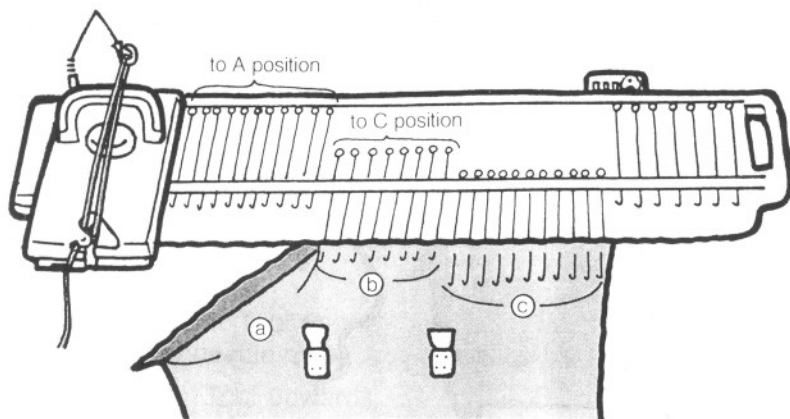

- Push back the needles of (b) section to C position.
- Hang the claw weights at both edges of (b) section.
- Knit 6 rows with waste yarn.
- Remove (b) section from the machine.
- Push back the empty needles to A position.

- Pull forward the Release Lever and remove the Carriage from the Needle Bed.
- Replace the Carriage on the original side.
- Push back the needles of (c) section to C position.
- Thread the main yarn through the Carriage.
- Continue to knit shaping the neck edge by decreasing stitches as required, according to your calculations.

How to decrease more than two stitches (Carriage side only)

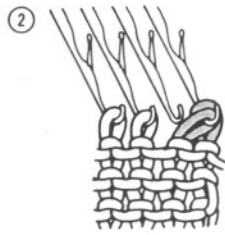
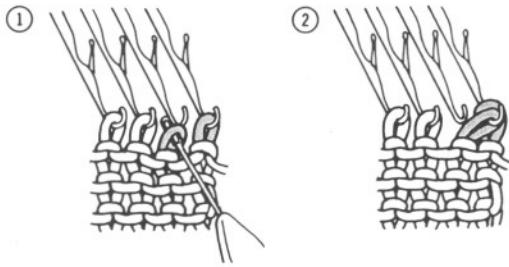

On the Carriage side hold the fabric against the knitter by hand. Transfer the second stitch onto the end needle.

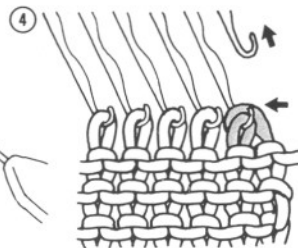
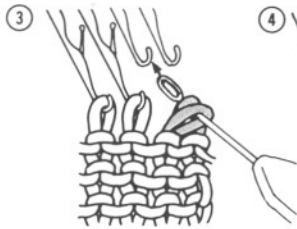

Transfer both stitches to the empty needle.

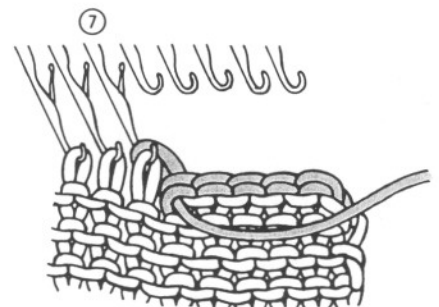
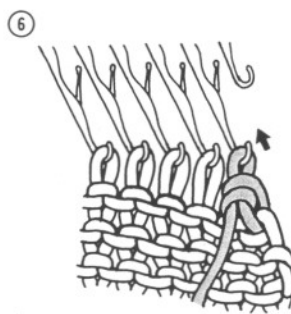
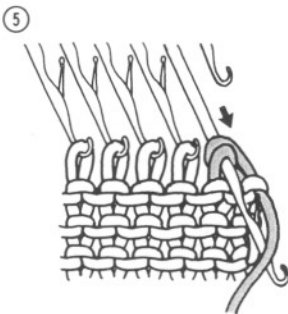

Push the empty needle to A position, lay the yarn across the open hook of the needle from the outside toward inside.

Hold yarn slightly down and push the needle back to B position. The two stitches slip off the needle.

Continue this procedure until the required number of stitches have been decreased.

Place the last stitch to be decreased onto its adjacent needle. (Two stitches remain on this needle.)

How to decrease one stitch

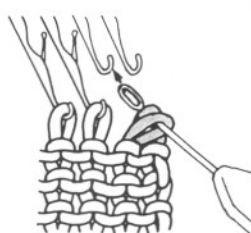

1. Transfer the second stitch onto the end needle.
2. Transfer both stitches onto the inside empty needle. Push the end empty needle back to A position.

- Complete the section according to your calculations.
- Break the yarn.
- Thread waste yarn through the Carriage.
- Knit 6 rows and remove the fabric from the machine.
- Push back the empty needles to A position.

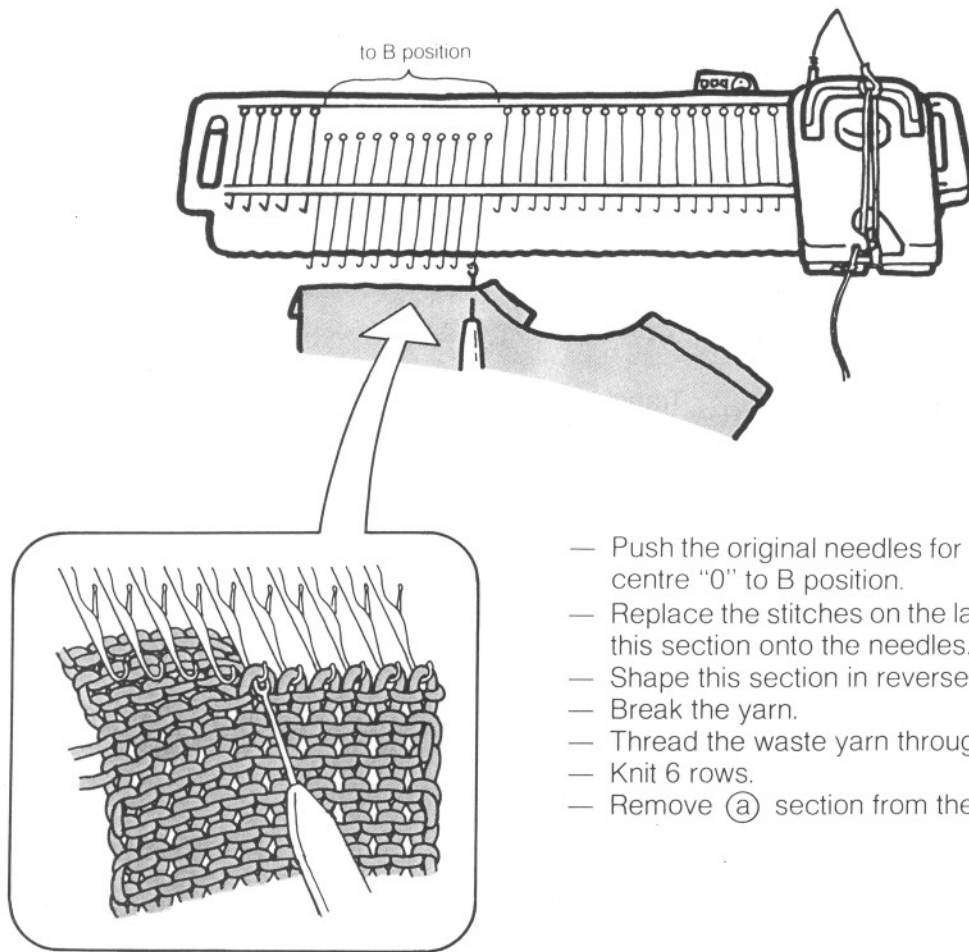

- Push the original needles for (a) section on the left to the centre "0" to B position.
- Replace the stitches on the last row of the main knitted section onto the needles.
- Shape this section in reverse.
- Break the yarn.
- Thread the waste yarn through the Carriage.
- Knit 6 rows.
- Remove (a) section from the machine.

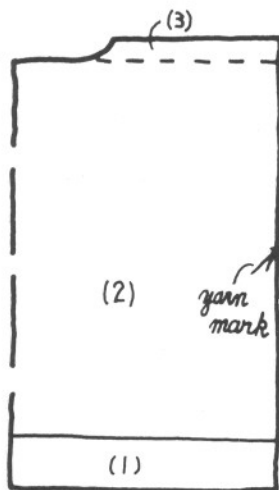

Back

- (1) Knitting the welt.
 - Push the required number of needles into the carriage for the width of the welt.
 - Work in the same manner as for the cuff of the sleeve in Step (1).
 - Reset the Stitch Dial to the original number and the tension switch.

- (2) Knitting Back.
 - Knit the required number of rows up to back neck line in the same way as for front.

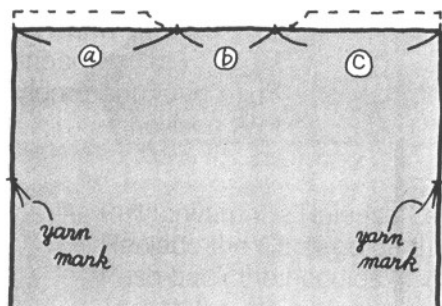

- (3) Shaping back neckline.
 - At the back neckline, divide into three sections: left, centre straight, and right.

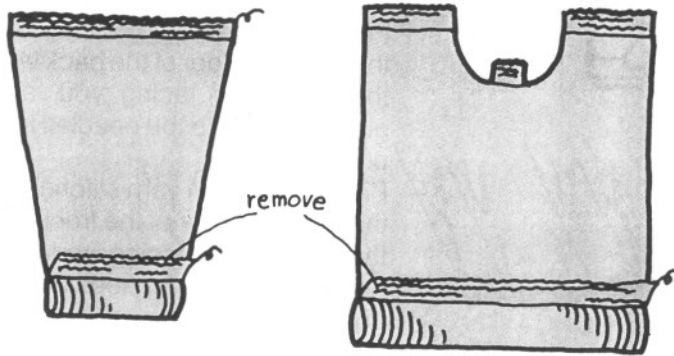
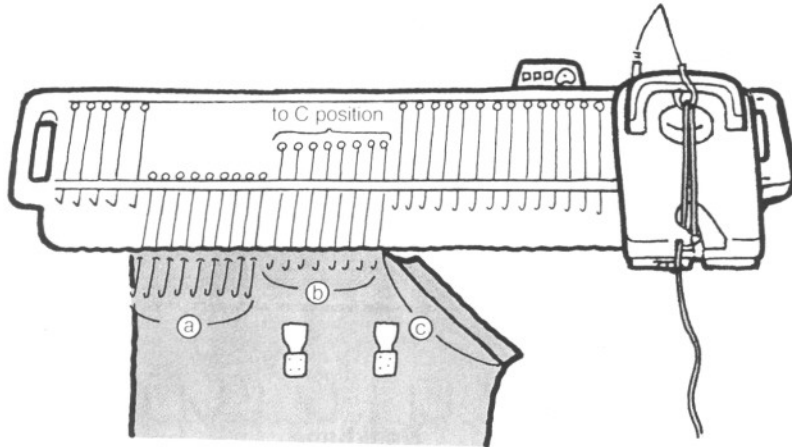
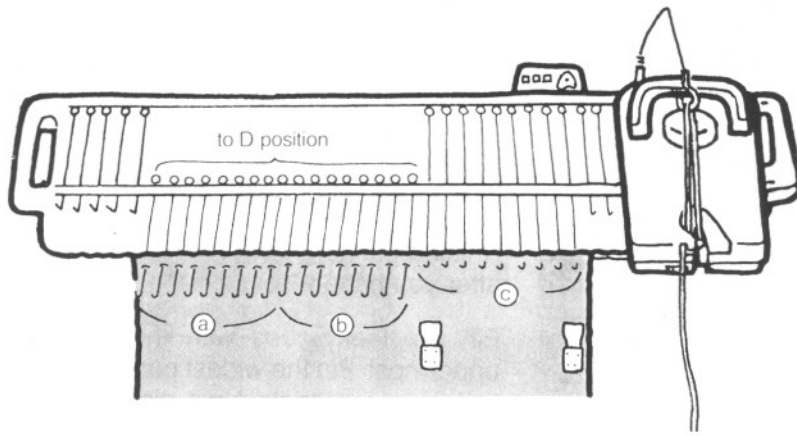

- If the carriage is on the right side, push the needles of (a) and (b) sections to D position.
- Knit shaping the back neck edge by decreasing stitches as required.
- Break the yarn.
- Thread waste yarn into the Carriage.
- Knit 6 rows and remove (c) section from the machine.
- Push back the empty needles to A position.

- Push back the needles of (b) section to C position.
- Thread the waste yarn through the Carriage.
- Knit 6 rows and remove (b) section from the machine.
- Push back the empty needles to A position.
- Push back the needles of (a) section to C position.
- Thread the main yarn through the Carriage.
- Shape section (a) in reverse manner.
- Knit 6 rows with waste yarn.
- Remove (a) section from the machine.
- Remove the waste knitting from the cuff or welt.

How to remove waste knitting

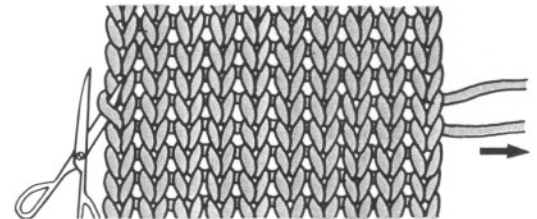

Cut the end stitch of the last row of waste knitting. Pull the waste yarn end. The waste knitting will separate from the main knitting.



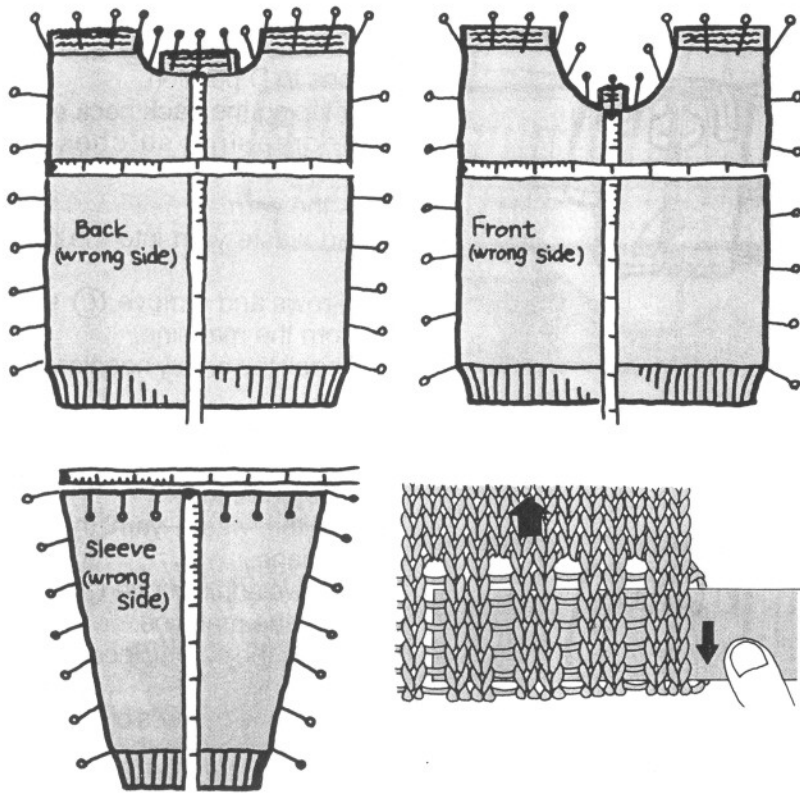

Blocking and pressing

After knitting the pieces of your garment, you must lay them flat and pin them out to their correct shape and size.

If some of the pieces vary in shape (either larger or smaller) it is possible at this stage to ease them into their correct size.

Knitting that is uneven will be much neater after you have pressed it.

Pin out the pieces with the wrong side uppermost. Pin the widest part first, then pin to the correct length. Next, pin all around the edges spacing the pins about 2 — 3cm. apart.

When pressing, insert a ruler into the side opening of the ribbed knitting and stretch fabric vertically, to close up rib stitches.

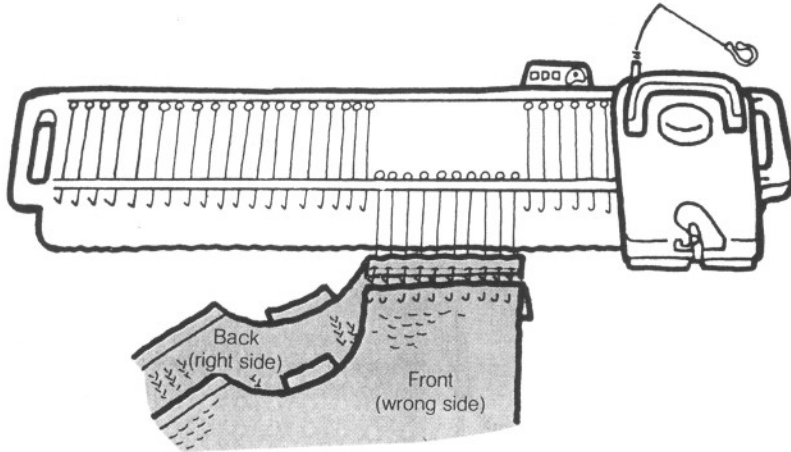

Neckband

(1) Join the right shoulder.

- Push to B position the same number of needles as the number of stitches on the shoulder.
- Pick up the main yarn stitches on the right shoulder of the back with the right side facing you, and place them onto the needles in B position.
- Pick up the main yarn stitches on the right shoulder of the front with the wrong side facing you, and place them onto the needles in B position.
- Push the needles to D position, holding the back shoulder against the sinker posts so the stitches of the back shoulder move behind the latches. (Stitches of the front shoulder remain in the needle hooks.)
- Unravel waste knitting on both shoulders.

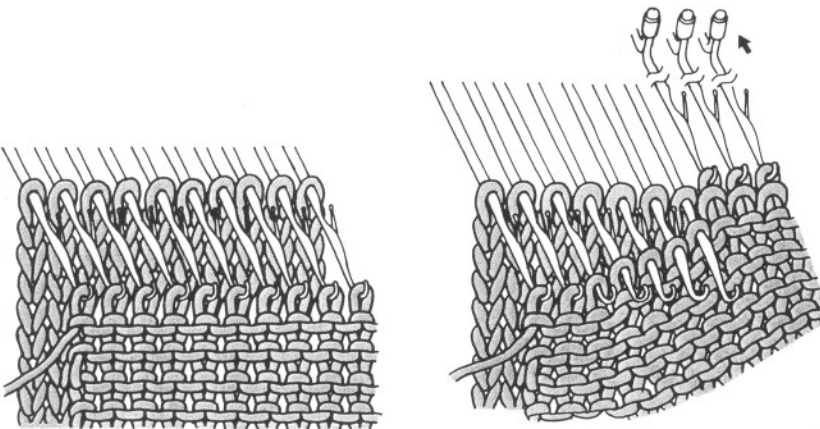

- Push the needles back to B position so the stitches behind the latches slip off the needles and over the stitches in the hooks.
- Close the stitches with the Back Stitch Method, using the Tapestry Needle and remove the fabric

How to close the stitches (Back Stitch Method)

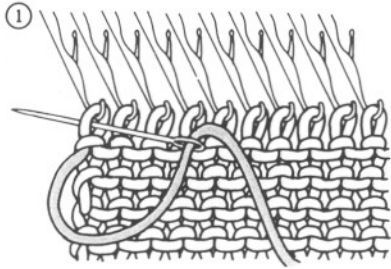

① Thread the Tapestry Needle and insert it into the first stitch and pull the yarn.

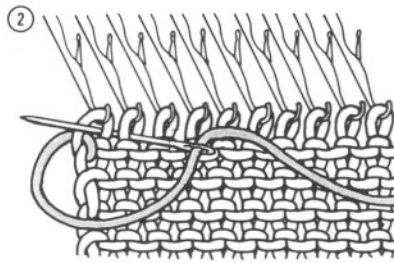

② Insert the Tapestry Needle in through the second stitch and out through the first stitch.

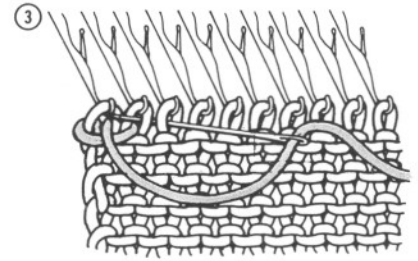

③ Insert the Tapestry Needle in through the third stitch and out through the second stitch.

Repeat steps ② ~ ③.
Close the last stitch by oversewing once.

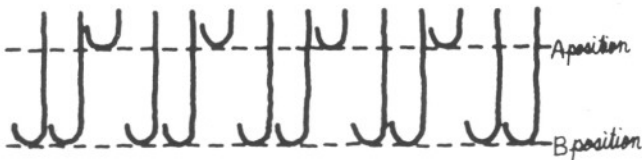

(2) Knitting the neckband.

- Push the required number of needles for the neckband to B position.
- Arrange the needles as shown.

- With the wrong side facing you, pick up the stitches from the neck edge evenly, and place them onto the needles.

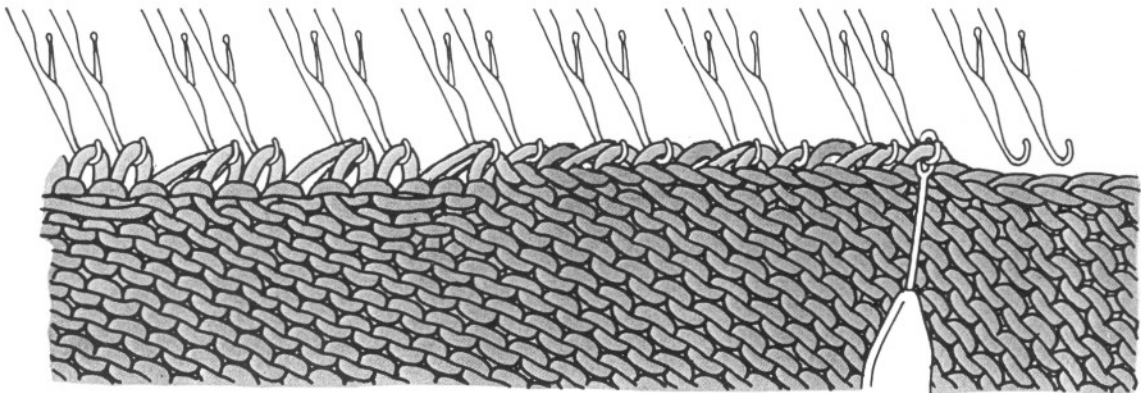

- Set the Stitch Dial 2 numbers lower than the main tension.
 - Push the needles to C position, holding the fabrics back against the sinker posts. Take care not to push the fabric forward.
 - Close the latches.
 - Work in the same manner as for the cuff of the sleeve in Step (1).
 - Reset the Stitch Dial to the original number of the tension switch.
- Knit 1 row and finish using the Back Stitch Method

TO MAKE UP

- (1) Join the other shoulder, using the same method as for right shoulder.
- (2) Set the sleeve in to the armhole.
 - Push the same number of needles as required the last row of sleeve, to B position.
 - With right side of the back and front facing, pick up the armhole stitches of the side edge.

— Place the stitches evenly on the needles in B position in the following order:—

- ① Pick up stitches at the yarn marks and place them at both ends of needles in B position.
- ② Pick up both stitches at shoulder seam and place one on each side of centre "0".
- ③ Pick up stitches between shoulder and yarn marks to fill the corresponding empty needles.

— Push the needles to D position, holding the fabric back against the sinker posts.

— With the wrong side of the sleeve facing you, pick up the stitches on the last row of the main knitting and place them onto the same needles.

(Back/front stitches are behind the latches, sleeve stitches are in needle hooks.)

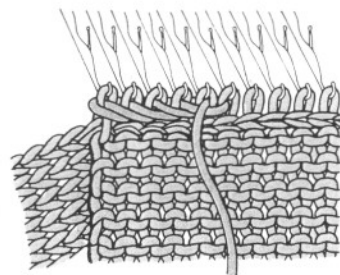
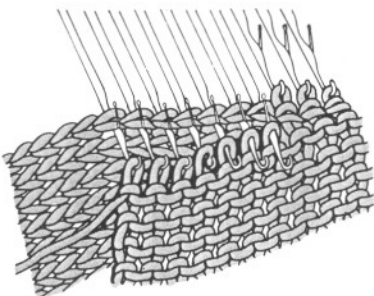
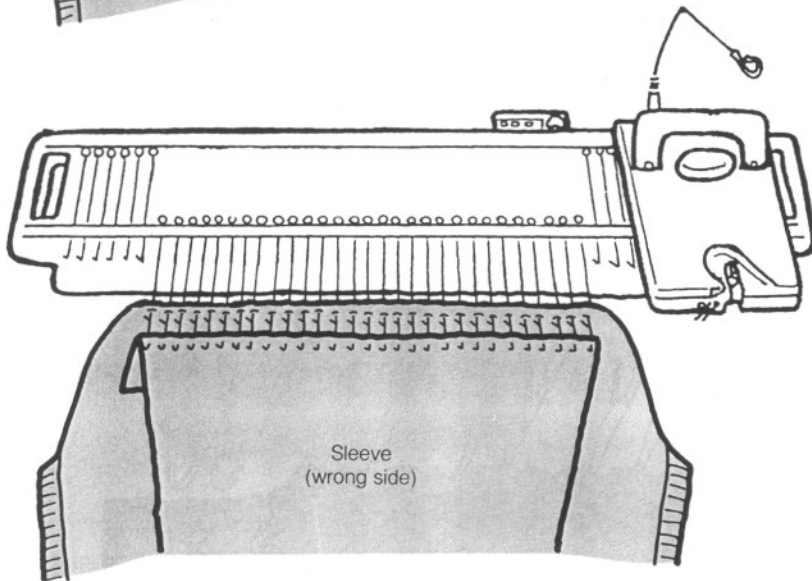
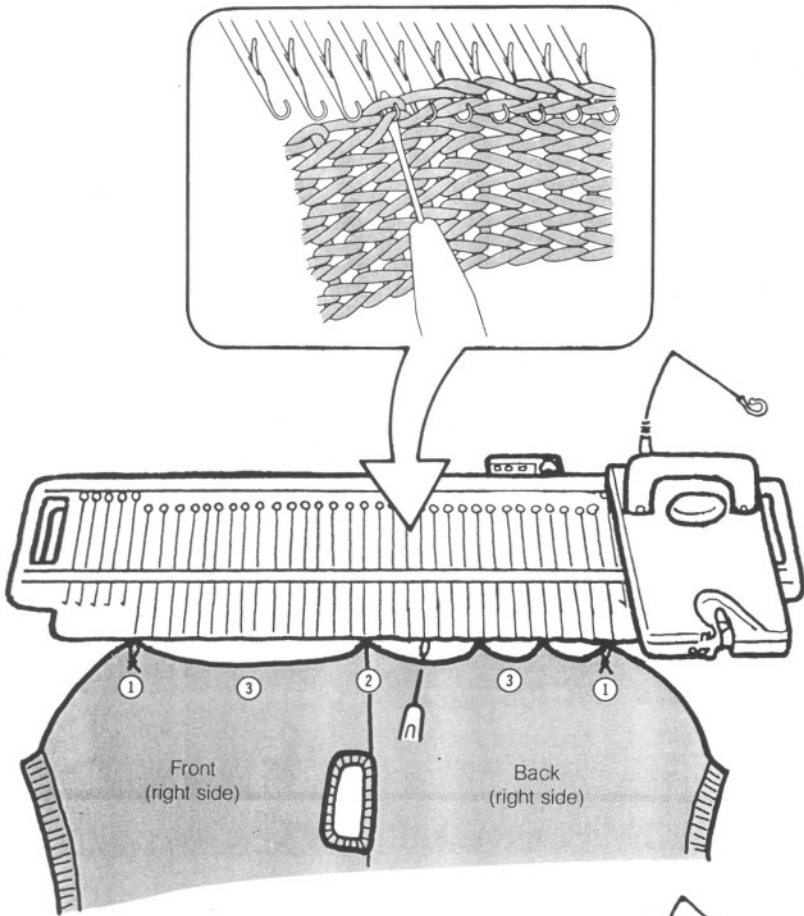

— Push back the needles to B position.

— The stitches behind the latches will slip off the needles. — Cast off the stitches using the Back Stitch Method

(3) Join the side and sleeve seams.

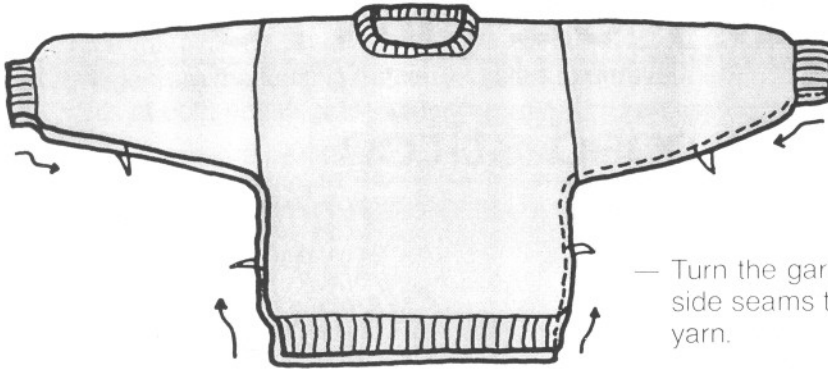

— Turn the garment to the right side, and sew side seams together with blind stitch using same yarn.

How to work blind stitch

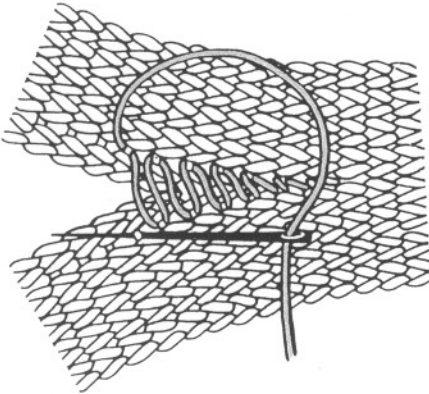

With the right sides facing you, pick up each sinker loop between the last 2 stitches from the side edge. Repeat this manner alternately, every row.

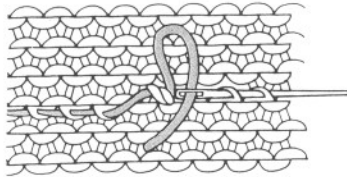
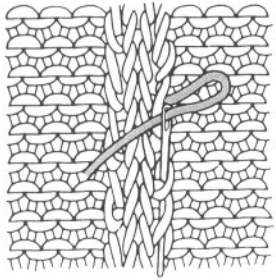

(4) Sew in the yarn end so as it is invisible on the inside of the garment.

(5) Give a final light press, according to yarn manufacturer's instructions.

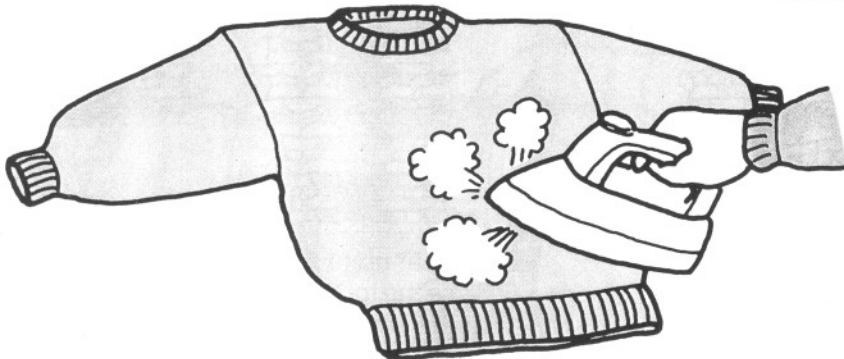

HELPFUL HINTS

To pick up a dropped stitch

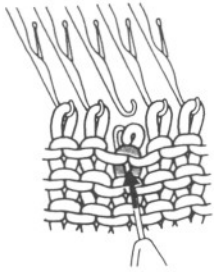

1. Insert a prong of Transfer Tool into the stitch 1 row below the dropped one.

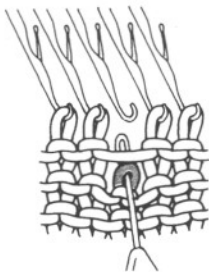

2. Unravel the dropped stitch, holding the stitch below on the Transfer Tool.



3. Replace stitch onto the empty needle together with the bar above the stitch.

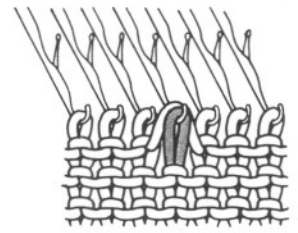

4. Push forward the needle till the stitch and the bar are behind the latch.

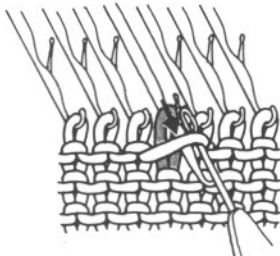

5. Lift up the bar using the Transfer Tool and bring it in front of the latch.

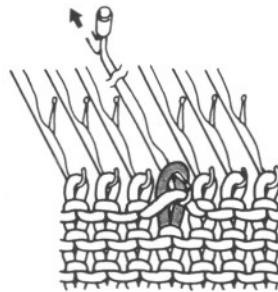

6. Push back the needle till the stitch behind the latch slips off the needle.

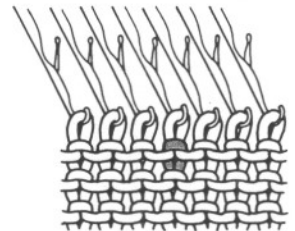

7. Push the needle back to A position to correct size of stitch and align the needle in B position.

If a dropped stitch has run down for several rows....

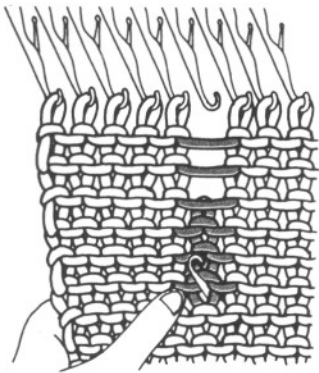

1. Holding the fabric with your hand, insert the Tapet Tool into a stitch a few rows below the dropped stitch from the rear side. Unravel the stitches down to the Tapet Tool

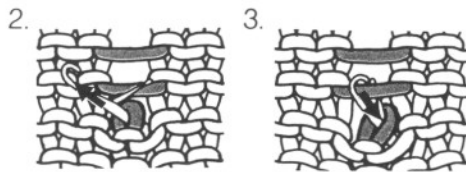

2. Push the Tool forward till the stitch moves behind the latch of the Tool.



3. Pull the Tool back catching the bar above inside to hook.

4. The stitch behind the latch slip off the Tool and

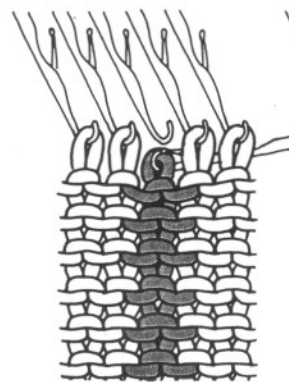

5. Repeat up to the top stitch.

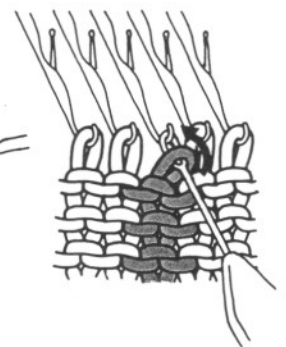

6. Take the top stitch onto the Transfer Tool at the front, and replace it in the empty needle hook.

To unravel knitted fabric on the machine

Remove the Carriage from the knitting before you start to unravel.
Hang Claw Weights at both edges of the knitting.

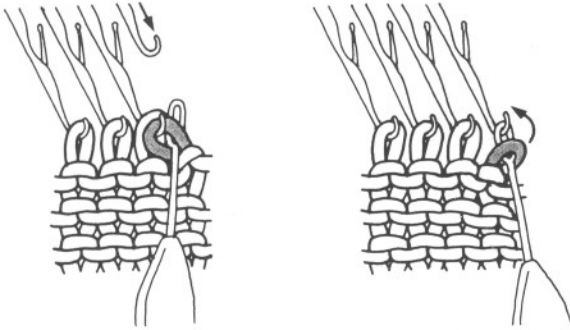

If the fabric has been shaped by decreasing at the edge, place the stitch back on its original needle.

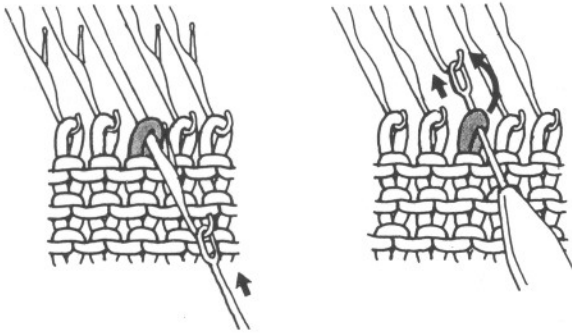

If the fabric has been shaped by partial knitting, return the needles from D to B position by replacing stitches in the needle hooks using Transfer Tool.

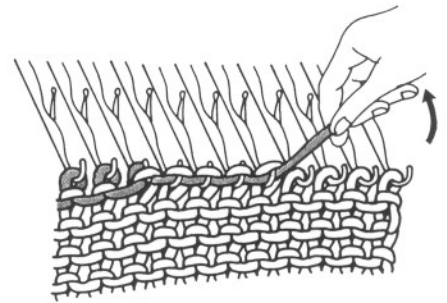
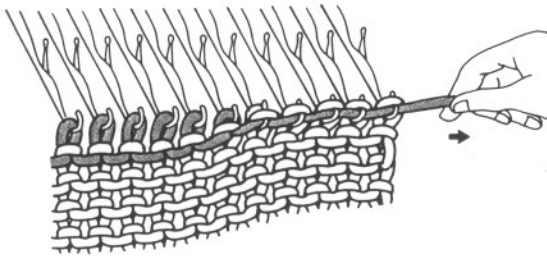

1. Holding the fabric down, pull the yarn sideways to tighten the stitches.

2. Lift the yarn upwards and very slightly backwards. The stitches of the previous row will slip back into the needle hooks.

3. Holding the fabric against sinker posts, push the needles to C position.

Turn back the number of rows unravelled on the Row Counter.
Eliminate slack yarn and continue to knit.

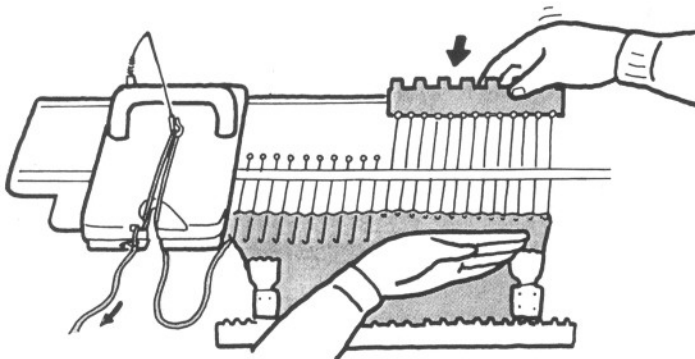

If the Carriage has jammed...

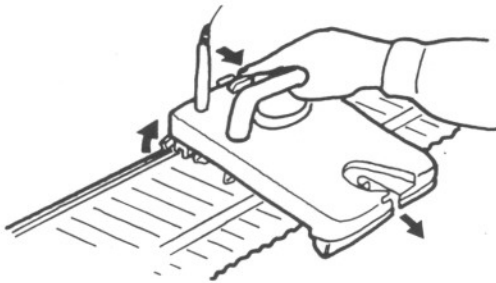
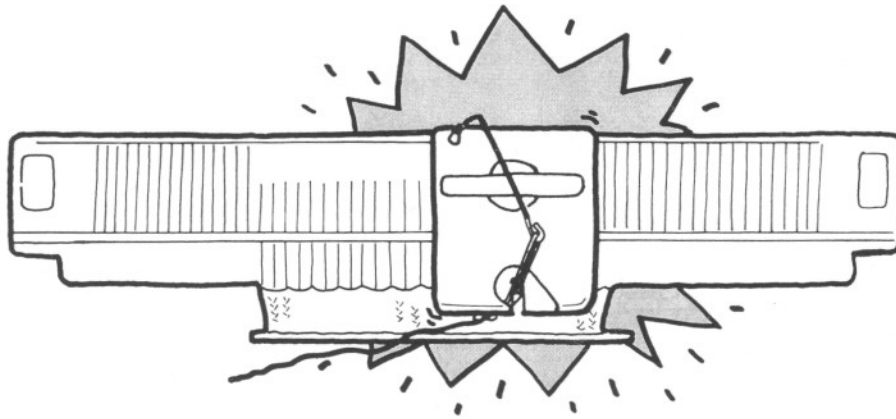

Remove the yarn from the Carriage.
Return the Row Counter if it was fed for the row.
Remove the Carriage from the Needle Bed and place it on either end of Needle Bed. (refer to page 3.)

* If you were knitting from the right to the left, place the Carriage on the right end of the Needle Bed.

* If you were knitting from the left to the right, place the Carriage on the left end of the Needle Bed.

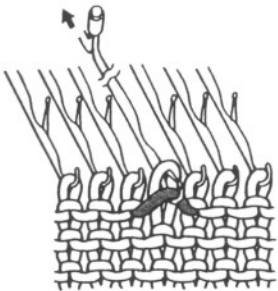

Pick up any dropped stitches. (refer to page 27.)

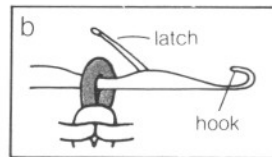
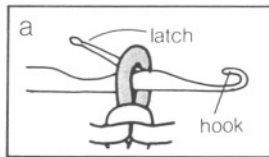

Return needles in D or C position back to B position.

Note: If the stitch is in the latch (a), push the needle back to B position.

If the stitch is behind the latch (b), return the needles following steps 1 ~ 3.

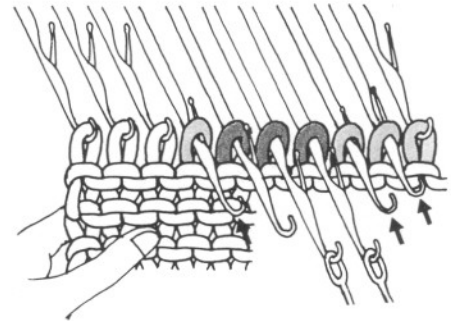

1. Insert needle hook into one, two or three prongs of Transfer Tool.

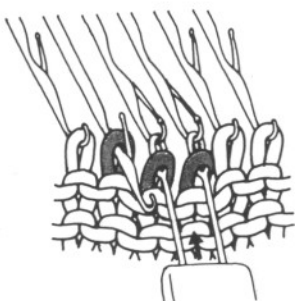

2. Push the Tool forward.
The stitches will move onto the Tool.

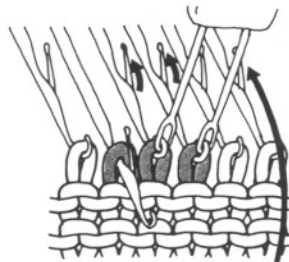

3. Turn the Tool upwards.
The stitches will slip into the needle hooks.

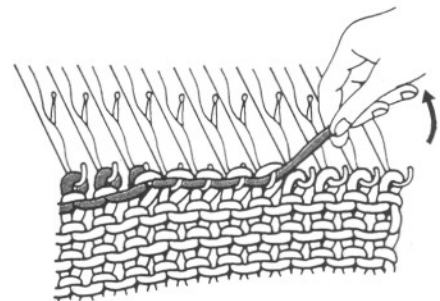

Unravel the incomplete row. (refer to page 28.)

Thread the yarn back into the Car-

To replace a damaged needle

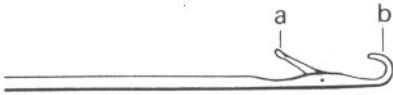

A needle with a damaged latch or bent hook will cause incorrect knitting or dropped stitches.

The needle latch "a" must move smoothly and lie flat over the hook "b".

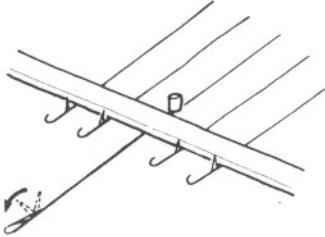

1. Push the damaged needle to D position and close its latch.

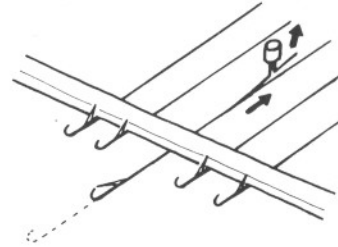

2. Lift up the needle with the needle roller and pull back to remove it from the Needle Bed.

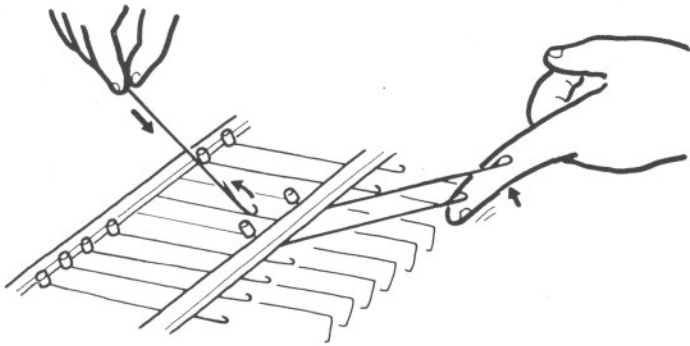

3. Push the needles on both sides of replaced needle to D position and lift them up.
Open the latch of a new needle and insert it into empty slot.

For successful knitting

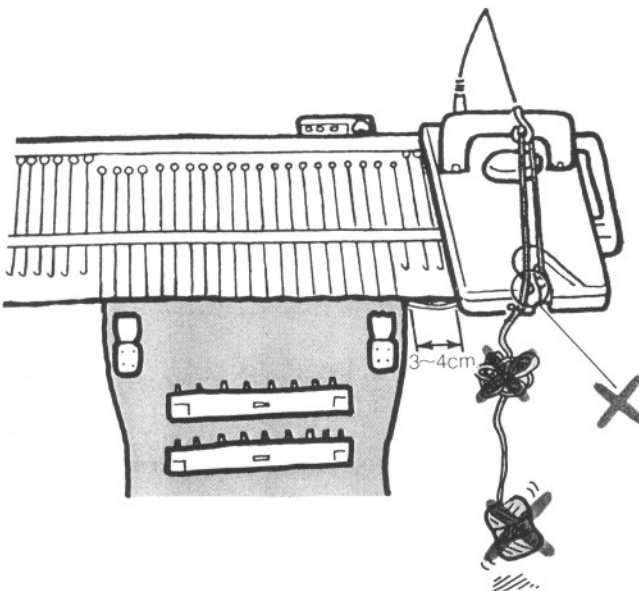

Ensure that...

- *Yarn feeds smoothly into Carriage.
- *Yarn is threaded correctly.
- *The Stitch Dial is correctly adjusted.
- *The needles are aligned correctly in position.
- *Composition of yarn is suitable for the Knitter.
- *Claw Weights are hanging on both EDGES of the fabric.
- *Claw Weights and Cast-on Combs are moved up every 20 rows.
- *Arm has passed the last knitted needle by approximately 3 — 4cms. before beginning the next row. (Do not move the Carriage too far from the fabric.)

MAINTENANCE

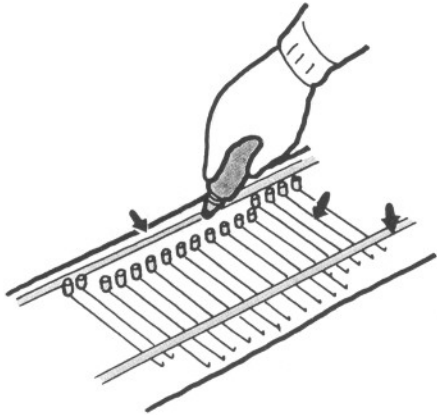

To clean your knitter, remove the Carriage from the Needle Bed.

Remove all fluff from needles and Needle Bed.

Apply oil along the rail and needle grooves.

With a soft oilcloth, wipe Needle Bed and needle rollers.

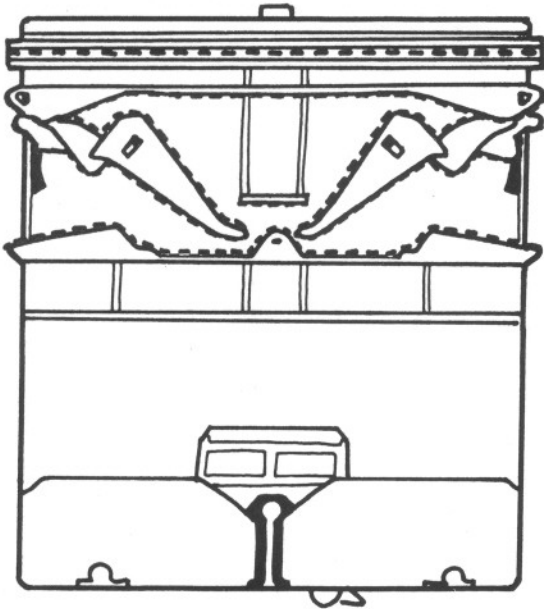







Turn over the Carriage and brush off all fluff and oil along red marked parts as shown on the diagram.

Replace the Carriage on the Needle Bed and move once or twice across the Needle Bed.

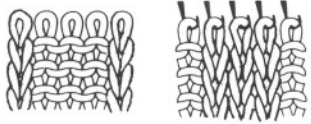
DO NOT USE THINNERS, PETROL OR ALCOHOL.

As the Carriage is heavy to operate, brush off fluff and apply antistatic spray over the machine with the needles in D position.

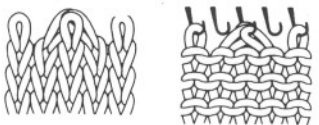
KNITTING SYMBOLS

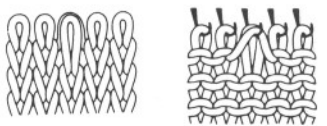
Symbols	How to make the stitches	Fabrics
—	This stitch is the side always towards you when knitting Stockinet on a machine.	
	Reform the stitch with a Tappet Tool.	
○	Transfer the stitch to the adjacent needle.	
λ	Transfer the stitch to the left and place together with the existing stitch.	
λ	Transfer the stitch to the right and place together with the existing stitch.	
†	Transfer the two adjacent stitches onto the needle.	
×	Cross the stitches with the right stitch over the left stitch.	
×	Cross the stitches with the left stitch over the right stitch.	
∩	Unravel the stitch and place it with the crossing bar above.	
∨	Unravel the stitch and place it omitting the crossing bar above.	