

# HOW TO USE KNITTING MACHINE

Manual is for KH-930 and KH\_940

## KH-940



brother®

# CONTENTS

## HOW TO USE YOUR KNITTING MACHINE

<b>PART NAMES</b> .....	1
MACHINE AND K CARRIAGE .....	1
CASE .....	1
NEEDLE .....	2
OPERATION PANEL .....	3
ACCESSORIES .....	5
<b>SETTING UP YOUR KNITTING MACHINE</b> .....	7
<b>REPLACING YOUR MACHINE INTO THE CARRYING CASE</b> .....	9
<b>BEFORE STARTING TO KNIT</b> .....	11
HOLDING CAM LEVER .....	11
CAM BUTTONS .....	11
CAM BUTTON RELEASE LEVER .....	11
WEAVING PATTERN LEVERS .....	11
CHANGE KNOB .....	12
TENSION DIAL .....	12
CAST-ON COMB .....	13
Using the Connecting Plate .....	13
NEEDLE POSITIONS .....	13
ROW COUNTER .....	13
L CARRIAGE .....	13
CLAW WEIGHTS .....	14
PREPARING YOUR YARN .....	14
<b>HOW TO OPERATE YOUR KNITTING MACHINE</b> .....	15
STOCKING STITCH (Plain Knitting) .....	15
1. Threading the yarn .....	15
2. How to cast on with a finished edge .....	16
Before you move the K Carriage .....	17
3. Stocking Stitch .....	18
Rubber Wheels .....	18
Plain and Purl sides of your knitting .....	18
4. How to remove your knitting from the machine .....	18

## HOW TO PROGRAM

<b>PROGRAM</b> .....	19
WHAT IS A PROGRAM? .....	19
PATTERN NUMBER .....	20
HOW TO SELECT THE PATTERN .....	20
"STITCH WORLD" Pattern Book .....	20
Diagram of one pattern repeat .....	20
<b>SELECTORS</b> .....	21
<b>ALL OVER PATTERNING</b> .....	22
SELECTOR (1) PATTERN A .....	22
SELECTOR (1) PATTERN B .....	25
Change the pattern position .....	25
<b>MOTIFS</b> .....	28
SELECTOR (2) Single Pattern repeat Motif .....	30
SELECTOR (2) Multiple Pattern repeat Motif .....	33
<b>HOW TO CHECK AND CORRECT YOUR PATTERN PROGRAM</b> .....	37
<b>HOW TO USE THE VARIATION KEYS</b> .....	40
1. REVERSE KEY .....	40

- 2. MIRROR IMAGE KEY ..... 41
- 3. DOUBLE WIDTH KEY ..... 43
- 4. DOUBLE LENGTH KEY ..... 45
- 5. UPSIDE DOWN KEY ..... 46
- 6. KHC KEY ..... 46
  - Without Single Bed Colour Changer ..... 46
  - With Single Bed Colour Changer ..... 47
    - Fairisle Pattern ..... 48
    - Multi-colour Tuck & Skip Patterns ..... 48
- 7. KRC KEY ..... 49
  - With Double Bed Colour Changer (KRC) ..... 49
- LIST OF VARIATION KEYS ..... 51

**MEMO PROGRAM ..... 52**

Indication in the Memo Display using the Keys ..... 52

**HOW TO PROGRAM THE "MEMO PROGRAM" ..... 53**

- 1. Entering the Memo Information ..... 53
- 2. Deleting the Memo Information ..... 54

MEMO INFORMATION IN THE PATTERNS IN "STITCH WORLD" ..... 55

**HOW TO PROGRAM YOUR OWN PATTERNS ..... 57**

Data Keys and Data Lamps ..... 57

**HOW TO PROGRAM (INPUT PROGRAM) ..... 58**

- 1. Storing your own Patterns ..... 58
  - Patterns more than 10 stitches in one row ..... 60
  - How to enter the same pattern data continuously ..... 61
  - What to do with "Blank" Pattern Data ..... 61
- 2. How to delete your own Patterns ..... 61
  - The Order Pattern Numbers appear in Input Programs ..... 62

**GUIDELINES WHEN MAKING YOUR OWN PATTERNS ..... 62**

**HOW TO CHECK THE PROGRAM FOR YOUR OWN PATTERNS ..... 63**

- 1. How to check the Pattern Numbers you have stored in the Computer ..... 63
- 2. Check the Pattern Data stored in the Computer ..... 63
  - Method 1 — Checking with the Data Lamp ..... 64
    - Correcting a mistake in the Program ..... 65
  - Method 2 — Checking with the Buzzer ..... 65
    - Correcting a mistake in the Program ..... 66

**SPECIAL PROGRAM ..... 67**

HOW TO BEGIN KNITTING MIDWAY THROUGH PATTERN ..... 67

HOW TO KNIT SEVERAL ROWS OF STOCKING STITCH BETWEEN PATTERN KNITTING ..... 69

- Use the Start Key ..... 69
- How to get back to Row 1 ..... 70

HOW TO CHANGE A VARIATION KEY WHILST YOU ARE KNITTING IN PATTERN ..... 70

- 1. How to change the Reverse, Double Width, Mirror Image or KHC Keys ..... 70
- 2. How to change the Double Length or Upside Down Key ..... 71

**FLOPPY DISC DRIVE**

**AN INTRODUCTION TO THE FLOPPY DISC DRIVE ..... 73**

**PART NAMES ..... 73**

**BEFORE YOU BEGIN TO PROGRAM ..... 73**

**HOW TO FORMAT YOUR DISCS (550) ..... 74**

**HOW TO SAVE YOUR PATTERN DATA (552) ..... 75**

**HOW TO LOAD YOUR PATTERN DATA (551) ..... 76**

**HOW TO DELETE YOUR PATTERN DATA (553) ..... 77**

## PATTERN KNITTING

<b>FAIRISLE PATTERN</b> .....	78
SELECTOR (1) .....	78
Rows with main yarn only .....	80
SELECTOR (2) Single Motifs .....	80
<b>TUCK STITCH PATTERN</b> .....	83
<b>OPEN TUCK STITCH PATTERN</b> .....	84
<b>MULTI-COLOUR TUCK STITCH PATTERN</b> .....	86
<b>SKIP STITCH PATTERN</b> .....	88
<b>MULTI-COLOUR SKIP STITCH PATTERN</b> .....	89
<b>WEAVING PATTERN</b> .....	91
When using more than two Weaving Yarns .....	93
Woven Pull-up Stitch .....	93
Winding method .....	94
How to knit some rows with the main yarn only .....	94
<b>THREAD LACE PATTERN</b> .....	95
SELECTOR (1) .....	95
Pull-up Pattern .....	97
SELECTOR (2) .....	97
<b>LACE PATTERN AND FINE LACE PATTERN</b> .....	100
SELECTOR (1) .....	100
How to set the L Carriage .....	100
SELECTOR (2) .....	102
<b>LACE AND FINE LACE MIXED</b> .....	103
<b>PLATING</b> .....	104
CHANGING MAIN YARN AND PLATING YARN .....	106
<b>PLATED TUCK STITCH PATTERN</b> .....	107
<b>INTARSIA KNITTING</b> .....	108

## MAKING GARMENTS

<b>HOW TO TRANSFER STITCHES</b> .....	110
<b>HOW TO INCREASE STITCHES</b> .....	110
<b>INCREASING ONE STITCH</b> .....	110
Simple Method .....	110
Fully-fashioned method .....	111
<b>INCREASING SEVERAL STITCHES</b> .....	111
<b>HOW TO DECREASE STITCHES</b> .....	112
<b>DECREASING ONE STITCH</b> .....	112
Simple method .....	112
Fully-fashioned method .....	112
<b>DECREASING SEVERAL STITCHES</b> .....	113
<b>PARTIAL KNITTING</b> .....	114
<b>1. PLAIN STOCKING STITCH AND PATTERN KNITTING</b> .....	114
Decreasing stitches using the Holding Position .....	114
Increasing stitches from the Holding Position .....	115
<b>2. LACE OR FINE LACE PATTERN KNITTING</b> .....	116
Decreasing stitches .....	116
Increasing stitches .....	117

3. INTARSIA KNITTING .....	118
Decreasing stitches .....	118
Increasing stitches .....	119
<b>HOW TO SHAPE A ROUND NECKLINE .....</b>	<b>119</b>
<b>USING THE HOLDING CAM LEVER .....</b>	<b>119</b>
Stocking Stitch and Plating .....	119
Pattern Knitting .....	121
The M Key .....	122
<b>USING THE CAST-ON THREAD .....</b>	<b>123</b>
Lace or Fine Lace Pattern .....	123
<b>HOW TO SHAPE A V-NECKLINE .....</b>	<b>125</b>
<b>TAKING PART OF THE KNITTING OFF ONTO WASTE YARN .....</b>	<b>125</b>
Stocking Stitch and Plating .....	125
Pattern Knitting .....	125
Lace and Fine Lace Pattern .....	126
<b>INTARSIA .....</b>	<b>126</b>
<b>HOW TO CAST ON WITH A FINISHED EDGE (CLOSED EDGE CAST-ON) ...</b>	<b>127</b>
<b>"E" WRAP METHOD .....</b>	<b>127</b>
<b>USING THE LATCHET TOOL (Chain Stitch Cast-on) .....</b>	<b>128</b>
<b>HOW TO CAST ON .....</b>	<b>130</b>
<b>WASTE KNITTING .....</b>	<b>130</b>
<b>BACKSTITCH CASTING OFF (Binding off) .....</b>	<b>131</b>
<b>USING THE TAPESTRY NEEDLE .....</b>	<b>131</b>
Ending with K Carriage on the Left .....	131
Ending with K Carriage on the Right .....	131
<b>CHAIN STITCH CAST OFF (Binding off) .....</b>	<b>132</b>
<b>USING THE LATCHET TOOL .....</b>	<b>132</b>
<b>WASTE KNITTING .....</b>	<b>133</b>
<b>SEAMING .....</b>	<b>134</b>
<b>USING A TAPESTRY NEEDLE .....</b>	<b>134</b>
<b>HOW TO USE THE LATCHET TOOL .....</b>	<b>134</b>
<b>MAKING RIB BY HAND .....</b>	<b>134</b>
<b>HOW TO MAKE A HEM .....</b>	<b>136</b>
<b>PLAIN HEM .....</b>	<b>136</b>
<b>RICOT HEM .....</b>	<b>137</b>
<b>1x1 ELASTIC HEM ("Mock Ribbing/Continental Ribbing") .....</b>	<b>139</b>
<b>CABLE STITCH PATTERN .....</b>	<b>140</b>
<b>TUBE KNITTING .....</b>	<b>140</b>
<b>HOW TO MAKE A BUTTONHOLE .....</b>	<b>141</b>
<b>USING A SEWING MACHINE FOR MAKE-UP .....</b>	<b>142</b>
<b>BEFORE YOU BEGIN TO SEW .....</b>	<b>142</b>
<b>ORDER OF MAKE-UP .....</b>	<b>142</b>

## USEFUL HINTS

<b>PROBLEMS DURING KNITTING .....</b>	<b>144</b>
<b>WHAT TO DO WHEN YOU CANNOT KNIT SMOOTHLY .....</b>	<b>144</b>
1. When the Needles don't catch the yarn properly .....	144
2. When the K Carriage is hard to push back and forth .....	144
3. When stitches are not formed correctly .....	144
4. How to pick up a dropped stitch .....	145
Repairing a dropped stitch .....	145
Repairing a stitch that has dropped several rows .....	145

<b>WHAT TO DO IF YOU MAKE MISTAKES AS YOU KNIT STOCKING STITCH AND PLATING</b> . . . . .	146
1. If the Carriage should jam . . . . .	146
How to put a stitch into the needle hook . . . . .	147
2. If you want to unravel some knitting . . . . .	148
<b>WHAT TO DO IF YOU MAKE MISTAKES AS YOU KNIT PATTERN KNITTING</b> . . . . .	149
1. If the K Carriage should jam . . . . .	149
When working in Thread Lace . . . . .	149
2. If you want to unravel some knitting . . . . .	151
3. If the selected needles are pushed back by mistake . . . . .	151
<b>WHAT TO DO IF YOU MAKE MISTAKES AS YOU KNIT LACE OR FINE LACE PATTERN KNITTING</b> . . . . .	151
1. If the L Carriage should jam . . . . .	151
2. If you want to unravel some knitting . . . . .	152
3. If you operate the L carriage for one extra row . . . . .	152
4. If the selected needles are pushed back by mistake . . . . .	153
<b>WHAT TO DO IF YOU MAKE MISTAKES AS YOU KNIT INTARSIA KNITTING</b> . . . . .	153
1. If the K Carriage should jam . . . . .	153
2. If you want to unravel some knitting . . . . .	153
<b>FAIRISLE, TUCK STITCH, SKIP STITCH, WEAVING, THREAD LACE &amp; PLATED TUCK STITCH PATTERNS</b> . . . . .	154
<b>WHAT TO DO IF YOU CANNOT REMEMBER HOW MANY ROWS YOU HAVE UNRAVELLED</b> . . . . .	154
<b>WHAT TO DO WHEN YOU HAVE ENTERED THE WRONG NUMBER FOR THE ROWS YOU HAVE UNRAVELLED</b> . . . . .	155
<b>WHAT TO DO IF THE ELECTRIC POWER IS CUT OFF WHILST YOU ARE KNITTING</b> . . . . .	155
<b>WHAT TO DO IF THE NEEDLES ARE SELECTED INCORRECTLY</b> . . . . .	156
<b>WHAT TO DO IF THE NEEDLES ARE NOT SELECTED AND REMAIN AT B POSITION</b> . . . . .	157
<b>WHAT TO DO WHEN THE LETTER "E" IS FLASHING ON AND OFF IN THE MEMO DISPLAY</b> . . . . .	157
<b>REPLACING A NEEDLE</b> . . . . .	157
<b>HOW TO CORRECT MISTAKES IN THE INPUT PROGRAM</b> . . . . .	159
<b>WHAT TO DO WHEN YOU USE THE <input type="checkbox"/> AND <input type="checkbox"/> KEYS INCORRECTLY</b> . . . . .	159
<b>WHEN INPUT PROGRAMMING</b> . . . . .	160
<b>WHAT TO DO IF THERE IS AN INSUFFICIENT NUMBER OR THERE ARE NO ROWS LEFT FOR YOUR OWN PATTERN PROGRAM</b> . . . . .	160
1. Stop the Input program . . . . .	161
2. How to delete another pattern . . . . .	161
3. How to Input program . . . . .	161
<b>WHAT TO DO WHEN THE DISPLAY DOESN'T INDICATE THE PATTERN NUMBER, EVEN IF THE INPUT KEY IS ON</b> . . . . .	162
1. How to delete the memorized pattern . . . . .	162
2. How to Input program . . . . .	162
<b>WHAT TO DO IF YOU WANT TO CHECK THE PATTERN DATA POSITION, WHILE YOU ARE ENTERING DATA</b> . . . . .	163
<b>WHAT TO DO IF THE ELECTRIC POWER IS CUT OFF WHILST YOU ARE ENTERING PATTERN DATA</b> . . . . .	163
<b>WHEN USING FLOPPY DISC DRIVE</b> . . . . .	164
<b>WHAT TO DO WHEN AN ERROR MESSAGE APPEARS</b> . . . . .	164
Error messages . . . . .	164
<b>IF THE LOW BATTERY ALARM LAMP IS LIT (WHILST USING THE BATTERIES)</b> . . . . .	166
<b>WHAT TO DO IF YOU WANT TO COPY A PATTERN FROM ONE DISC ONTO ANOTHER</b> . . . . .	166
<b>CLEANING AND MAINTENANCE</b> . . . . .	167

# HOW TO USE YOUR KNITTING MACHINE

## PART NAMES

### MACHINE AND K-CARRIAGE

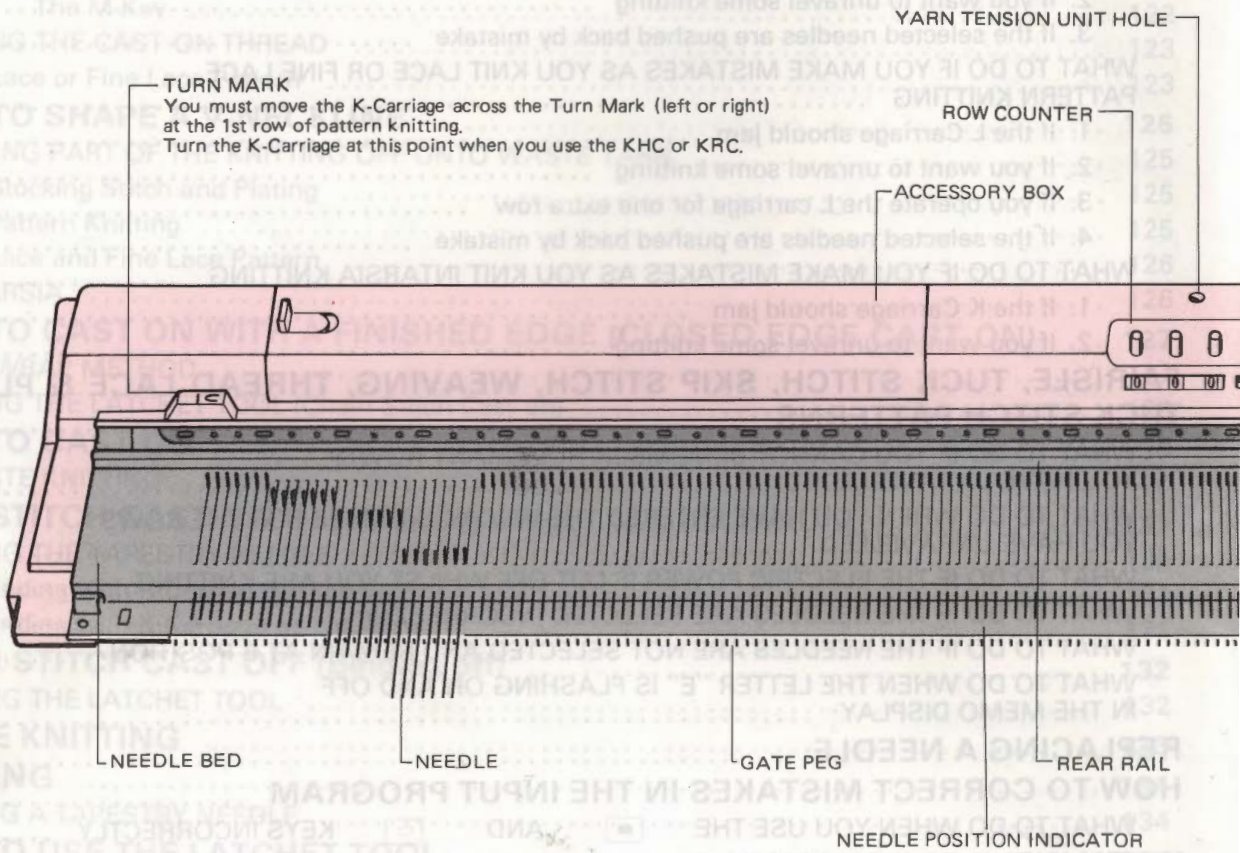

### CASE

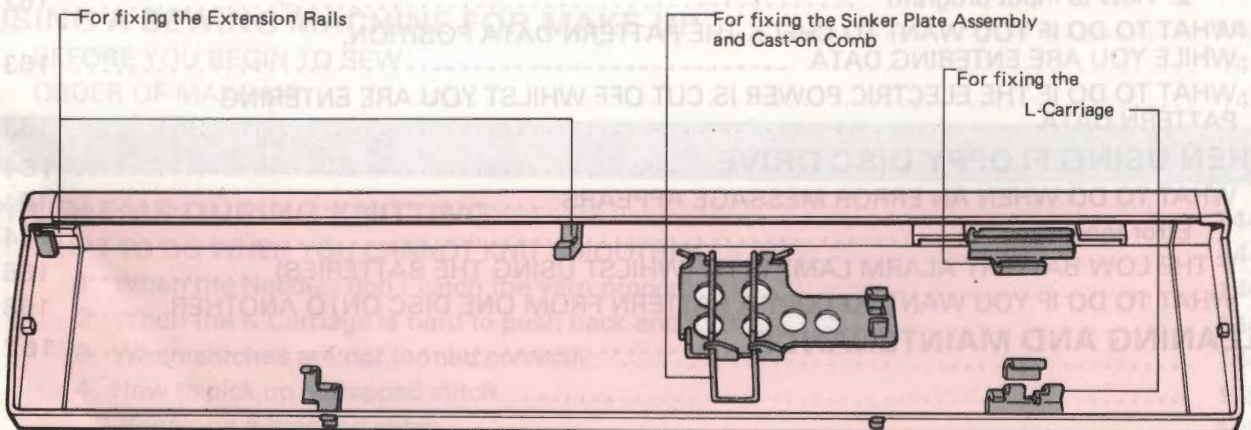

# OPERATION PANEL

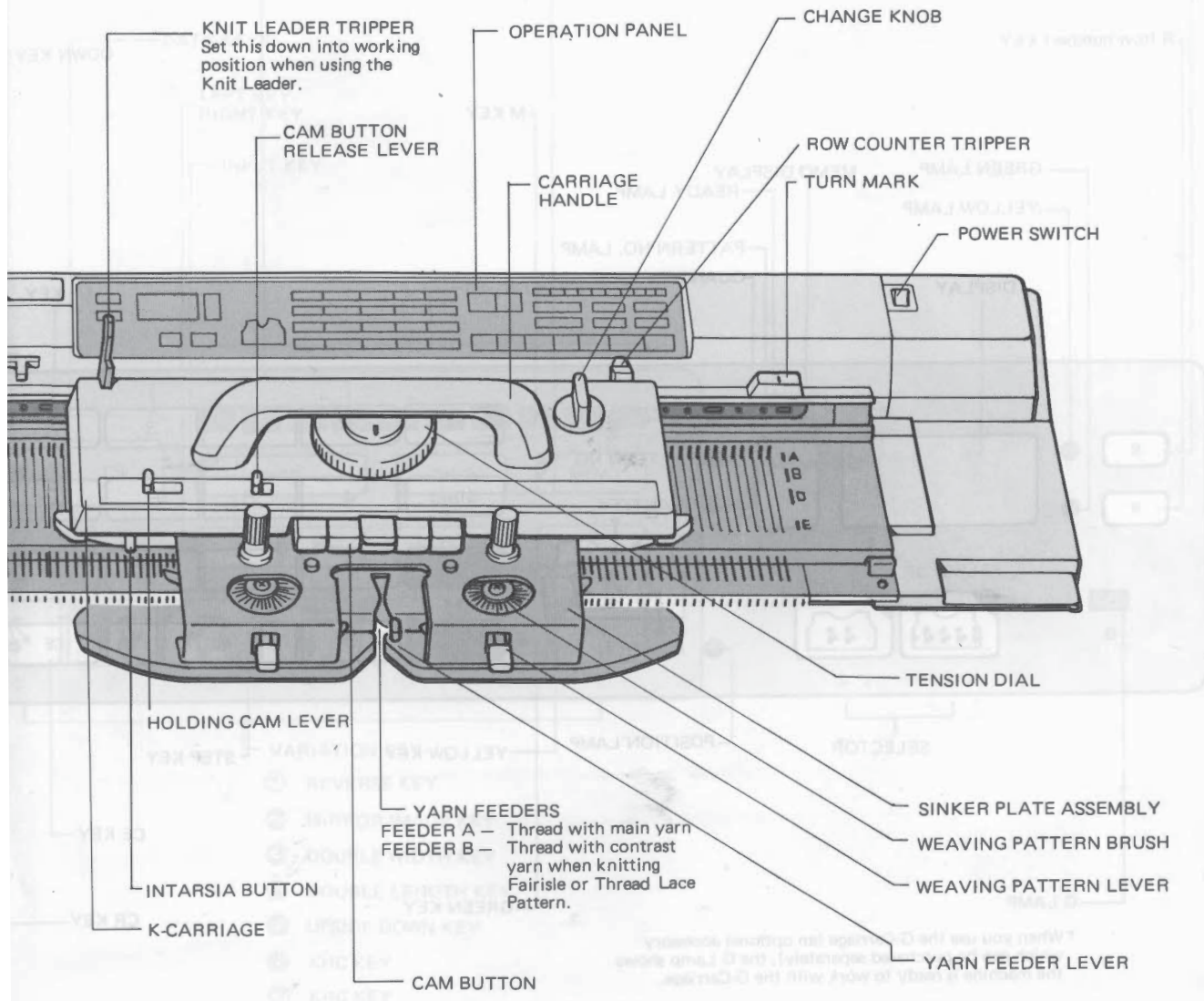

## NEEDLE

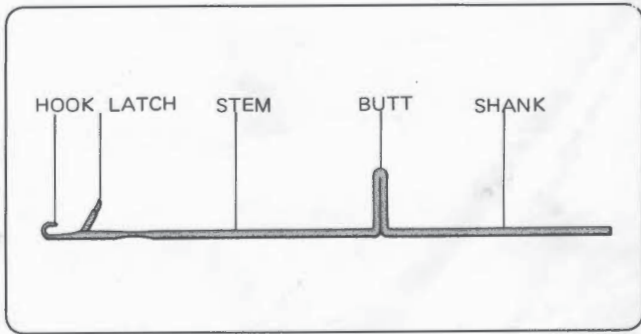



PART NAMES  
OPERATION PANEL

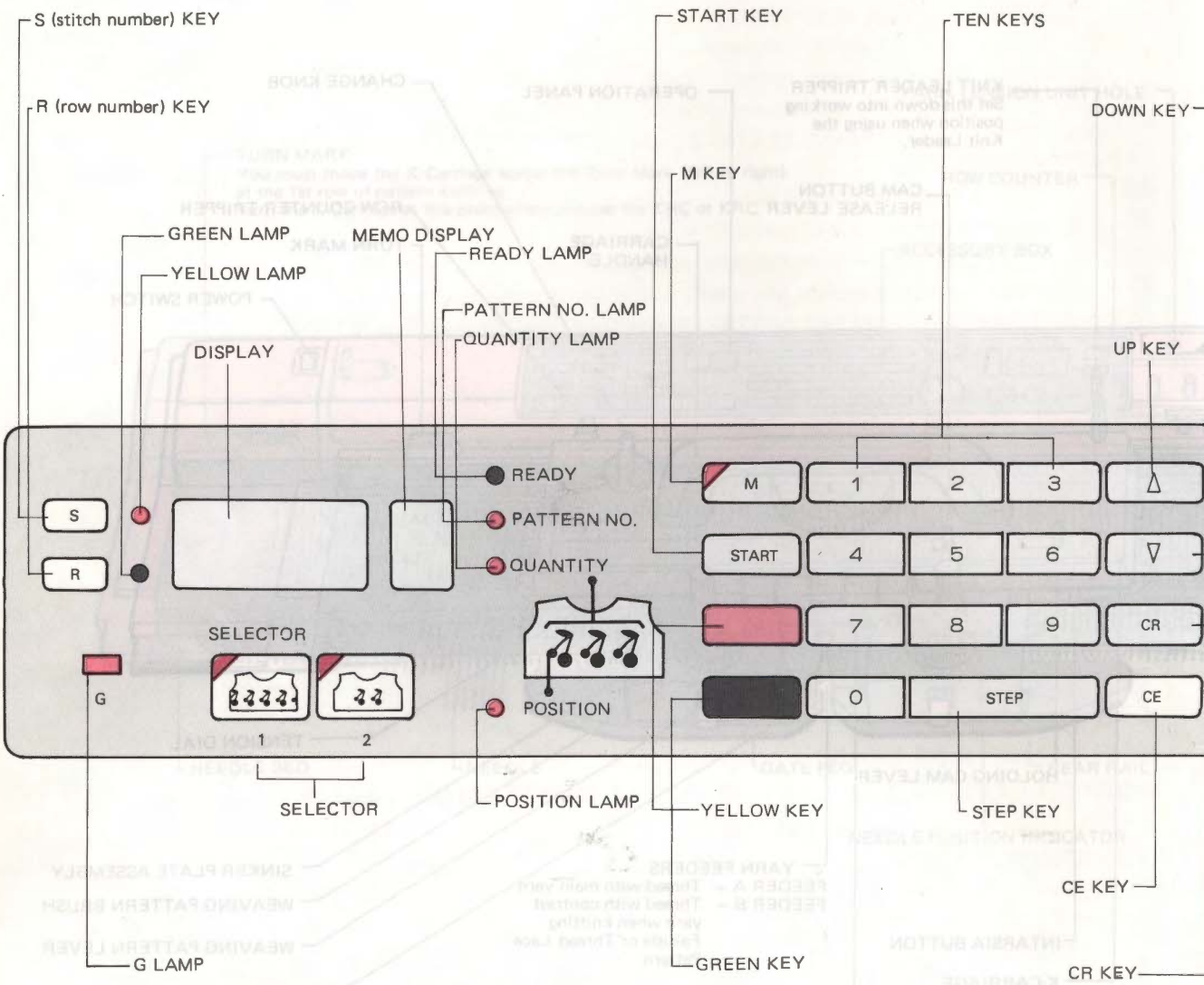

\* When you use the G-Carriage (an optional accessory which can be purchased separately), the G Lamp shows the machine is ready to work with the G-Carriage.

CASE

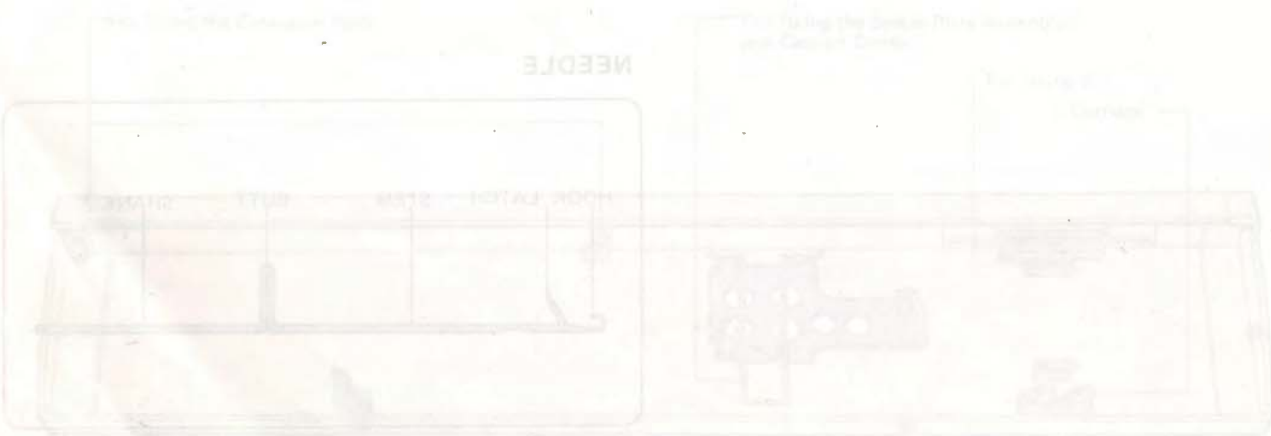

VOLUME DIAL

Use this to alter the volume of the Buzzer.

DATA KEYS

LEFT KEY  
RIGHT KEY

INPUT KEY

DATA LAMPS

1 2 3 4 5 6 7 8 9 0

INPUT

CHECK

MEMO

VARIATION

1 2 3 4 5 6 7  
KHC KRC

CHECK KEY

MEMO KEY

C KEY

BUZZER KEY

VARIATION KEY

- ① REVERSE KEY
- ② MIRROR IMAGE KEY
- ③ DOUBLE WIDTH KEY
- ④ DOUBLE LENGTH KEY
- ⑤ UPSIDE DOWN KEY
- ⑥ KHC KEY
- ⑦ KRC KEY

# ACCESSORIES

Stitch World  
(Pattern Book)



Design Sheet



Yarn Tension Unit

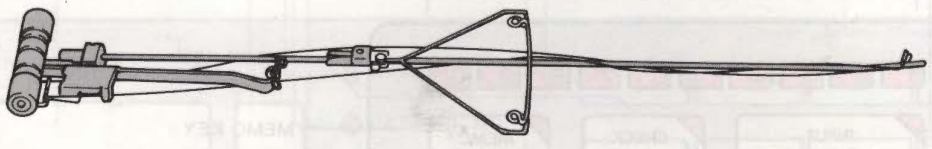

Cast-on Comb



Extension Rails



L-Carriage

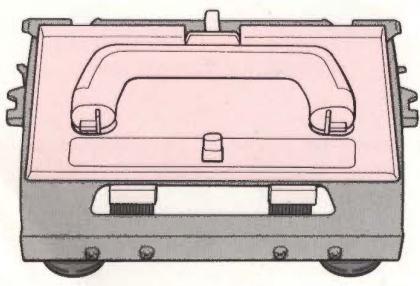

Power Cord



# SETTING UP YOUR KNITTING MACHINE

Crochet Hook



Latchet Tool

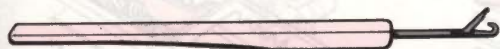

Transfer Tools

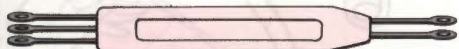
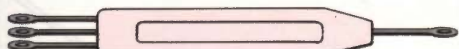
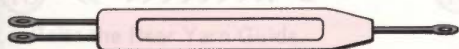

Needle Pusher

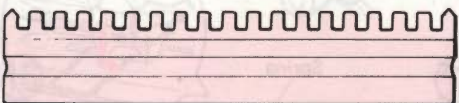

Cast-on Thread



Tapestry Needle



Spare Needles

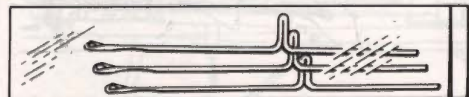
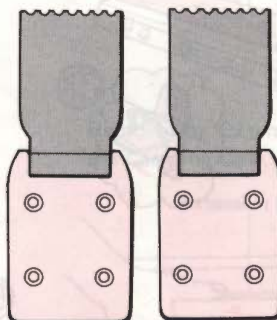

Table Clamps



Claw Weights



Hand Brush

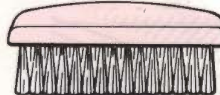

Plating Yarn Feeder

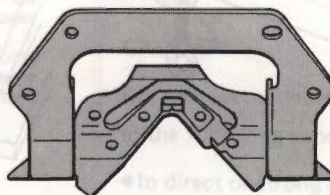

Latch Opening Plate

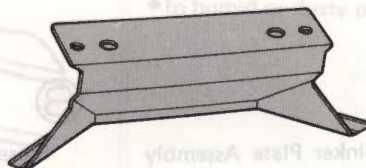

Oil



Yarn Wax



Carriage Lock

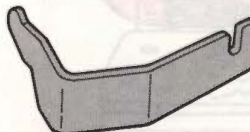

You can slide your K and L Carriages into the Extension Rail during knitting.

# SETTING UP YOUR KNITTING MACHINE

## ① ACCESSORIES

Place the machine on a firm table, with the Carrying Case Handle away from you and unlock the catches. Lift up the case top and pull it towards you to release the lid.



## ②

Open the Accessory Box.

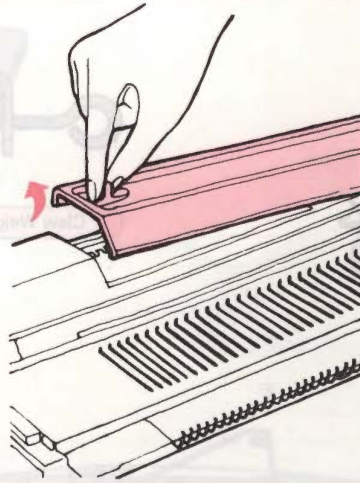

## ③

Take the two Table Clamps out of the Accessory Box.

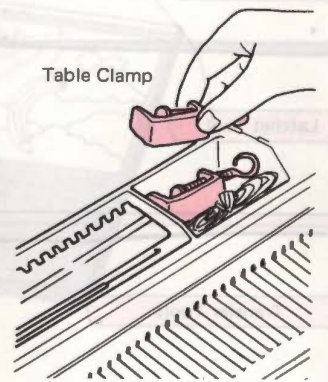

## ④

Fasten the machine to the table with the Table Clamps.

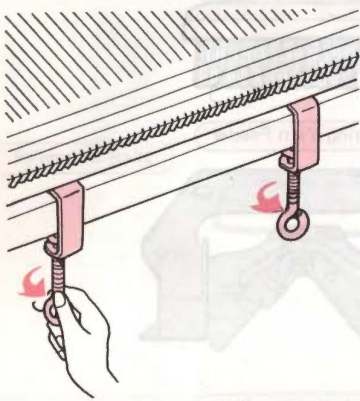

## ⑤

Loosen the knob and remove the Carriage Lock.

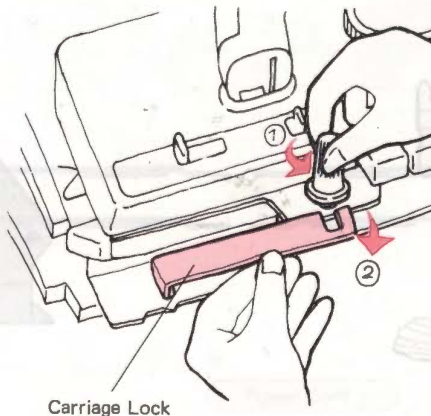

## ⑥

Release Spring and remove the Sinker Plate Assembly from the lid of the Carrying Case.

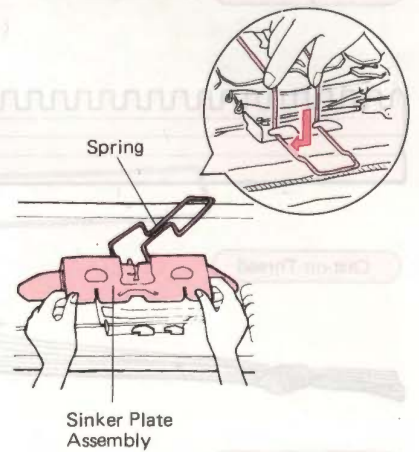

## ⑦

Screw the Sinker Plate Assembly onto the K-Carriage.

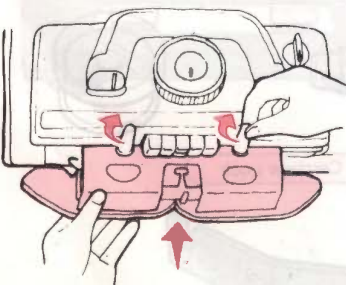

## ⑧

Raise the Carriage Handle by pulling it towards you, then move the Carriage to the right of the needle-bed.

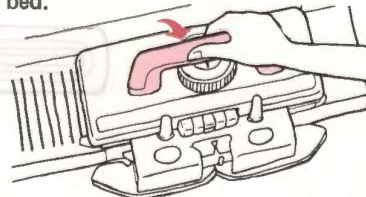

## ⑨

Take the Yarn Tension Unit out of the Carrying Case lid in the order 1, 2, 3 as shown.

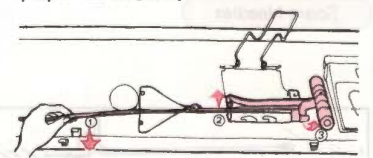

10

Unwind the Take Up Springs from the Rod.

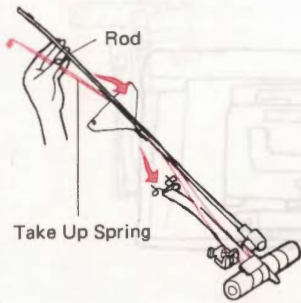

11

Lift the Front Guide Arm in the direction of the arrow as far as it will go.

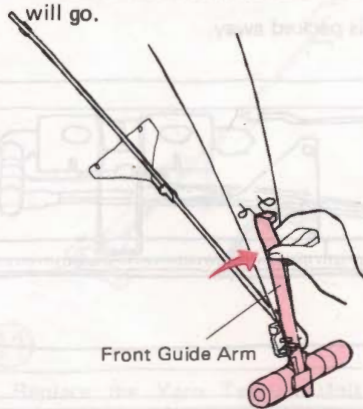

12

Turn back the Take Up Springs until you hear a "Click".

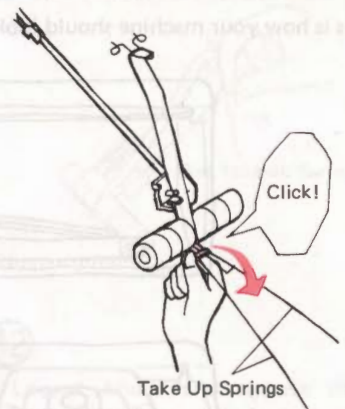

13

Raise the Rear Yarn Guide.

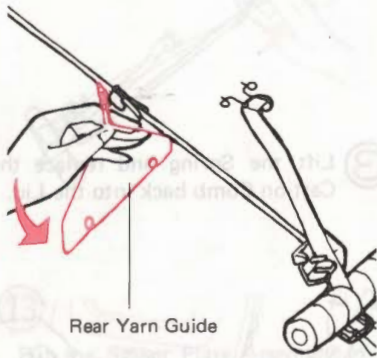

14

Insert the end of the Rod into the hole at the back of the machine.

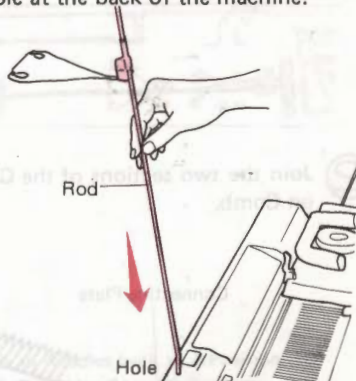

15

Remove the Extension Rails from the Carrying Case.

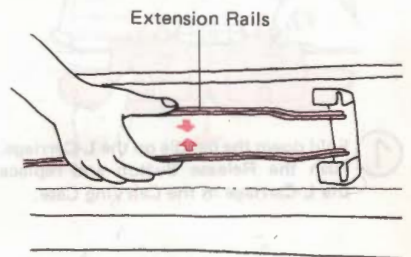

16

Insert the Extension Rails into the holes at both ends of the machine.

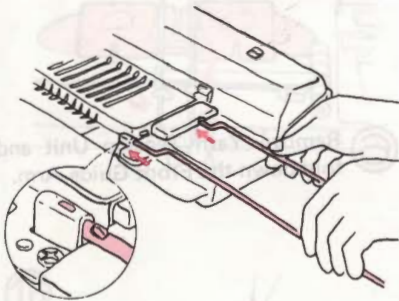

17

After turning off the power switch, plug one end of the Power Cord into the machine, and the other into the power supply socket and switch on. When you aren't programming or going to do pattern knitting, (e.g. you are only using stocking stitch) you don't need to plug the machine in.



The machine is now set up.

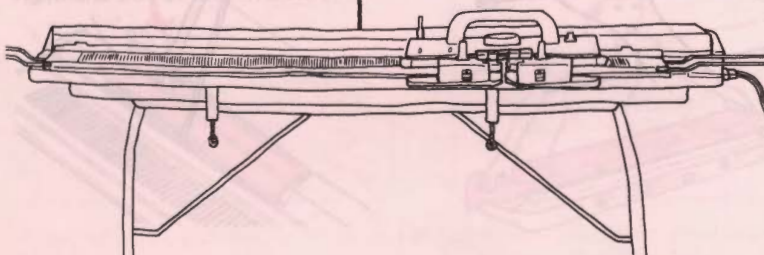

You can slide your K and L Carriages onto the Extension Rails during knitting.

### CAUTION

Do not use or leave the machine in the following conditions.

- In direct or strong sunlight.
- Close to a hot object such as a heater.
- In humid or dusty places.

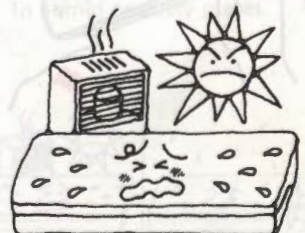

# REPLACING YOUR MACHINE INTO THE CARRYING CASE

This is how your machine should look when it is packed away.

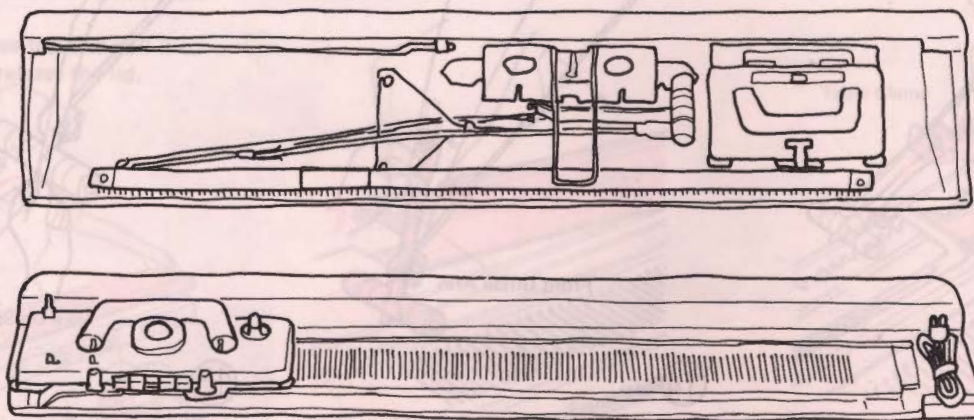

- ① Fold down the handle on the L-Carriage. Push the Release Button and replace the L-Carriage in the Carrying Case.

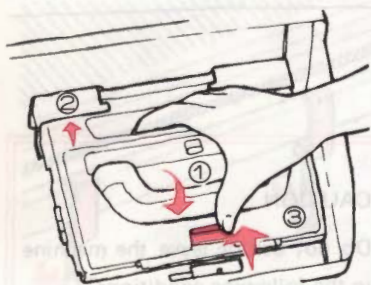

- ② Join the two sections of the Cast-on Comb.

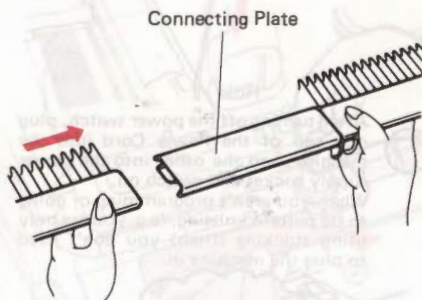

- ③ Lift the Spring and replace the Cast-on Comb back into the Lid.

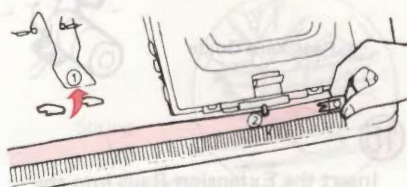

- ④ To remove the Extension Rails, lift up and pull.

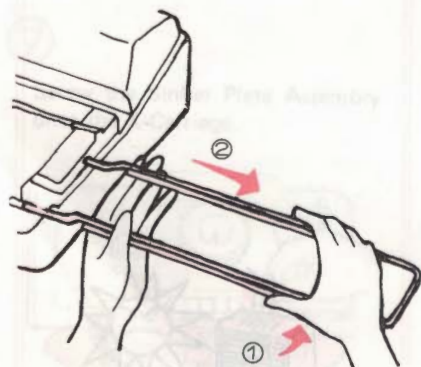

- ⑤ Put the Extension Rails in the Carrying Case.

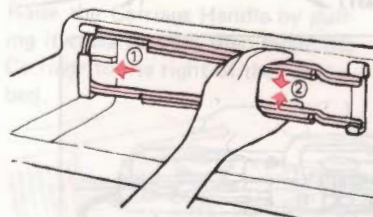

- ⑥ Remove Yarn Tension Unit and fold down the Front Guide Arm.

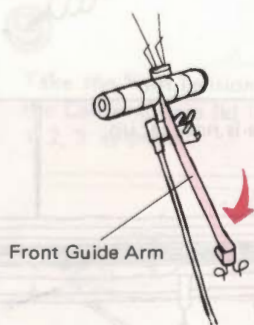

7

Next fold down the Take-up Springs.

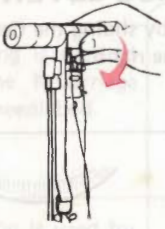

8

Wind and fix the Take-up Springs as shown in the illustration.

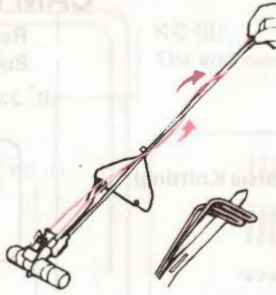

9

Put the Sub Take-up Spring on the Rod.



10

Fold down Rear Yarn Guide.

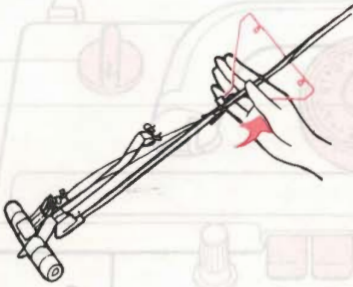

11

Replace the Yarn Tension Unit into the Case in the order 1, 2, 3 as shown.

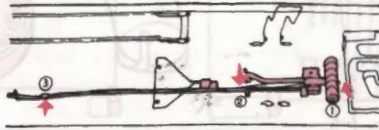

12

Loosen knobs and remove the Sinkers Plate Assembly from the K-Carriage.

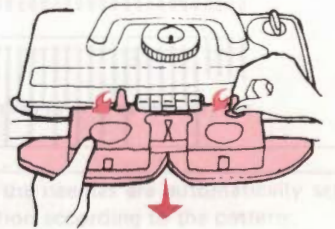

13

Put the Sinkers Plate Assembly in the Case where indicated and secure it with the Spring.

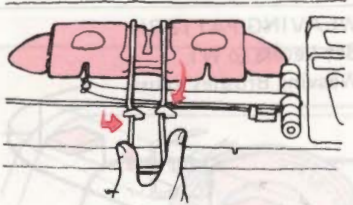

14

Push all Needles back to A Position and fold down Handle on K-Carriage. Insert the Carriage Lock into the hole in the left side of the machine and secure the K-Carriage as illustrated.

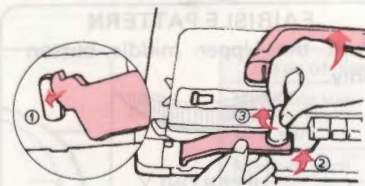

15

Unscrew the Table Clamps and put them in the Accessory Box with the other parts.

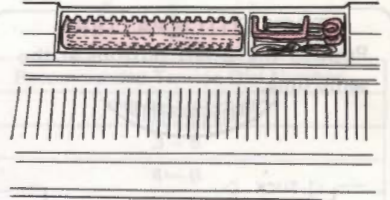

16

Then close the lid of the Accessory Box. After you turn off the power, unplug the cord and place it on the righthand side of the needlebed.

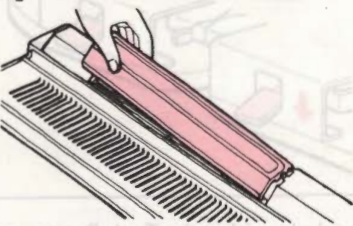

17

Hold the lid and replace it as shown. When it is in place, lock the two catches on either side of the Handle.



Do not store your machine in the following conditions.

1. In direct or strong sunlight.
2. Close to a hot object such as a heater.
3. In humid or dusty places.





# BEFORE STARTING TO KNIT

## HOLDING CAM LEVER

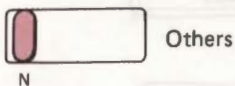
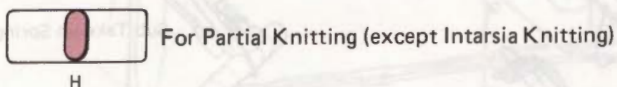
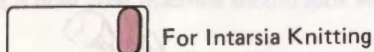

## CAM BUTTON RELEASE LEVER

Release the Cam Buttons by sliding the Cam Button Release Lever to the right.

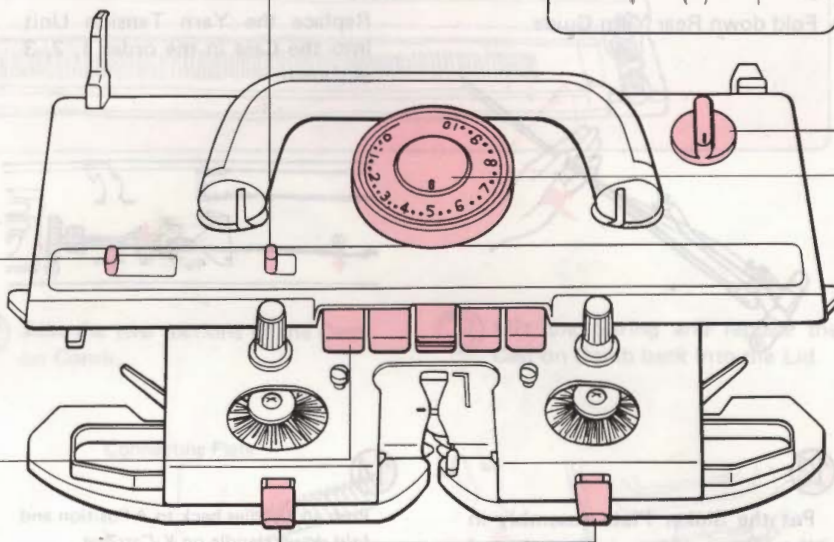
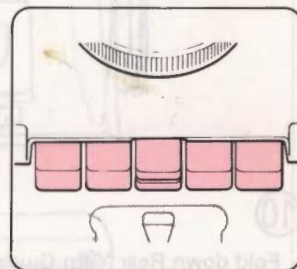
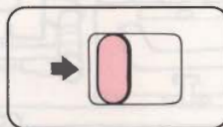

## CAM BUTTONS

Use the Cam Buttons according to the pattern you want.

### TUCK STITCH PATTERN

Push in the 2 left buttons at the same time.

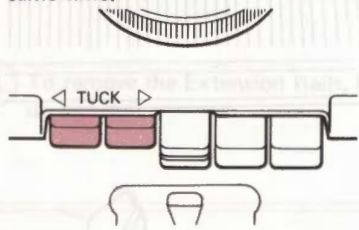

### FAIRISLE PATTERN

Push the Upper middle button only.

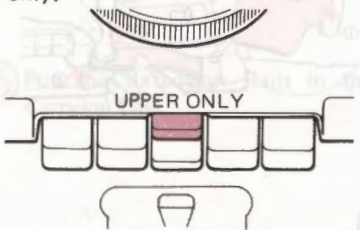

### WEAVING PATTERN

Set Levers to WT  
Weaving Brushes in use.

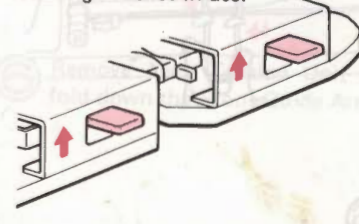

### SKIP STITCH PATTERN/ INTARSIA KNITTING

Push in the 2 right buttons at the same time.

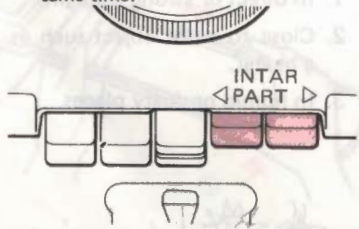

### THREAD LACE PATTERN

Push in both middle buttons (Upper & Lower) at the same time.

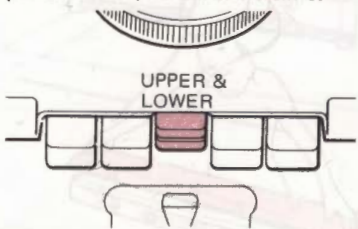

### Other occasions

Set Levers to N  
Weaving Brushes not in use.

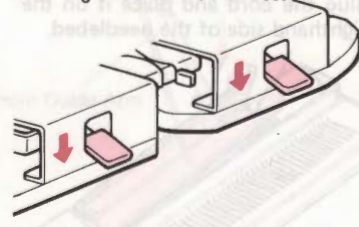

\* Do not operate the K-Carriage if you have depressed both middle Button (Upper & Lower) plus either the Tuck Button, or the Part Buttons.

### CHANGE KNOB

**CR**  
This setting is used to release the K-Carriage from the needlebed.

**N-L**  
This setting is used for Stocking Stitch, Lace Pattern and Intarsia.

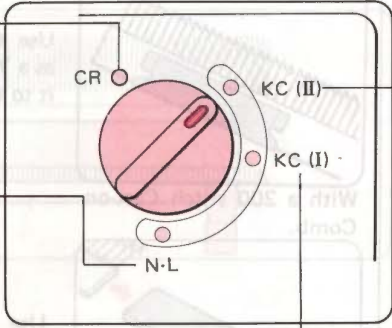

**KC (II)**  
The end needles are selected according to the pattern.

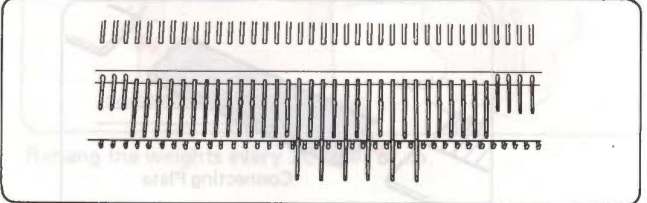

**KC (I)**  
The end needles are automatically selected on each row regardless of the pattern sequence.

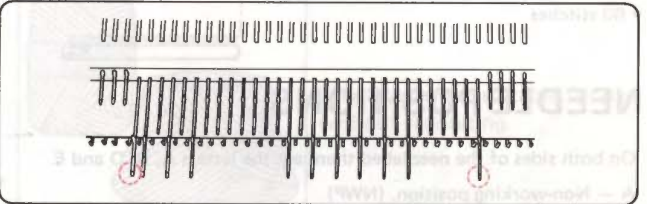

\* During pattern knitting, the needles are automatically set into B position or D position according to the pattern.

\* The Cam Buttons are automatically released when you set the Change Knob to N-L.

### TENSION DIAL

This dial is graduated from 0 to 10, each space being subdivided into three parts. With this dial you can alter the size and tension of your stitches. 0 is the tightest tension (i.e. the smallest stitch) and 10 is the loosest tension (i.e. the largest stitch).

You should adjust the dial to a higher or lower number according to the thickness and type of yarn you are using.

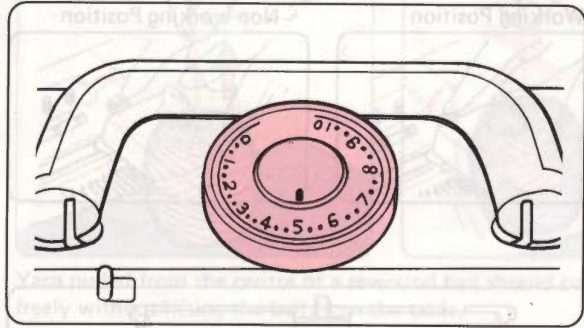

Type of Yarn	Recommended Tension Dial Number
Very fine yarn	0 - 3
Fine yarn	3 - 5
Medium yarn	4 - 6
Thick yarn	7 - 10
Very thick yarn	4 - 6*

As there are so many different types of yarn, it is impossible for us to tell you which Tension Dial Number you should use. You must decide for yourself which is correct for your yarn by working sample swatches. Use the information above as a rough guide only.

\* For very thick or bulky yarns, use every other needle or even every third needle.

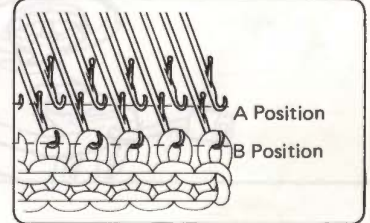

## CAST-ON COMB

The Cast-on Comb is in two sections of 140 and 60 needles, making a total of 200 needles. You can take these apart by removing the Connecting Plate if you wish to shorten the length.

- 200 stitches

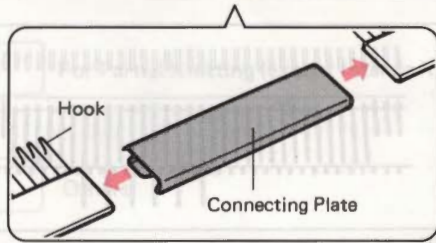
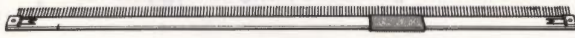

- 140 stitches

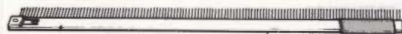

- 60 stitches

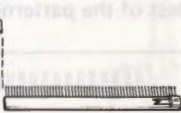

## NEEDLE POSITIONS

On both sides of the needlebed there are the letters A, B, D and E.

- A – Non-working position. (NWP)
- B – Working position. (WP) Used for general knitting purposes.
- D – Upper Working Position. (UWP) Selected needles are brought to this position in pattern knitting by the K or L Carriages.
- E – Holding Position. (HP) Needles in this position do not knit until released. Used for shaping e.g. necklines, shoulders, darts).

\* When you pack your machine away, always return the needles to A position.

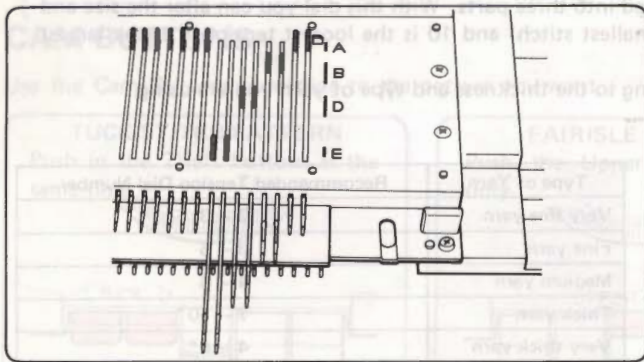

## L-CARRIAGE

With the L-Carriage you select and transfer stitches automatically. Use this to make Lace patterns.

### Using the connecting plate

With a 140 or 60 stitch Cast-on Comb.

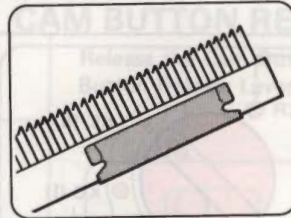

Use the Connecting Plate as a Yarn Clip by attaching it to the end of the Comb.

With a 200 stitch Cast-on Comb.

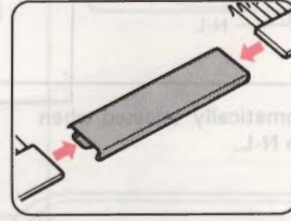

Use the Connecting Plate to join the two Cast-on Combs together.

## ROW COUNTER

The Row Counter shows the number of rows that have been knitted with the K-Carriage.

When you want to set the number back to "000" again, turn the knobs in the direction of the arrows.

\* When using the Row Counter, don't forget to set the Row Counter Tripper into working position.

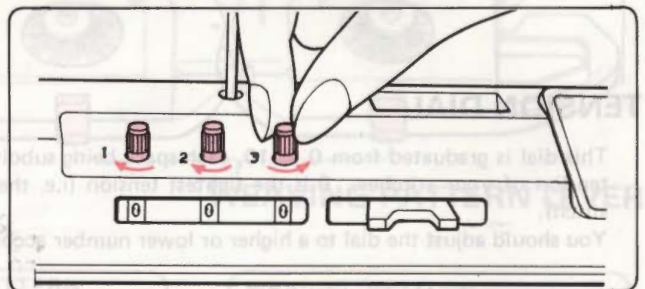

Working Position

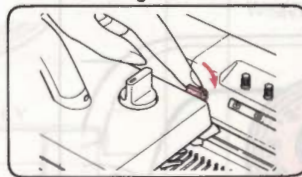

Non-working Position

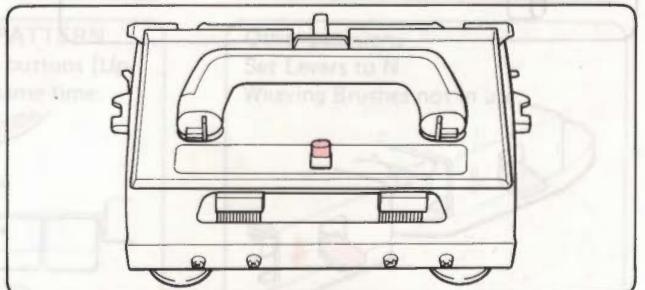
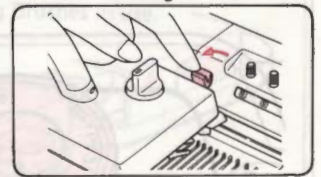

Lace Change Lever

- N – Normal Lace pattern knitting
- F – Fine Lace pattern knitting

## CLAW WEIGHTS

These are used to help your knitting hang properly and to prevent it from lifting up whilst you work.

- Hang claw weights onto your Cast-on Comb so that your knitting hangs evenly.

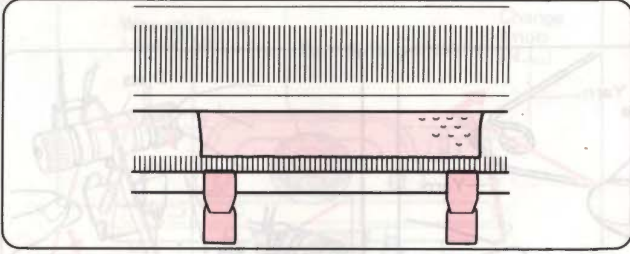

If the edges of your knitting don't lie smoothly, hang Claw Weights on both edges of the actual knitting.

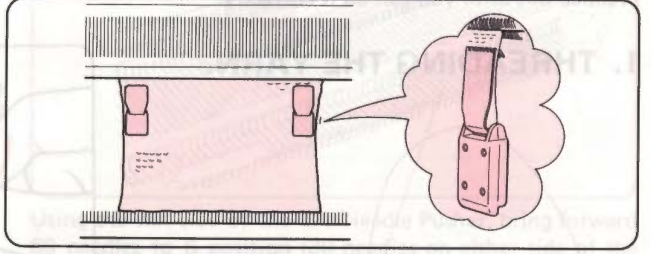

Rehang the weights every 20 rows or so.

## PREPARING YOUR YARN

When you are new to machine knitting, you are advised to start with new yarn. Choose one that is smooth and of reasonably good quality. Avoid hairy and harsh, poor-quality yarns as they are difficult to knit.

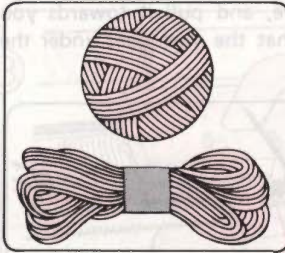

These yarns should be rewound using a Skein Winder and a Yarn Winder.

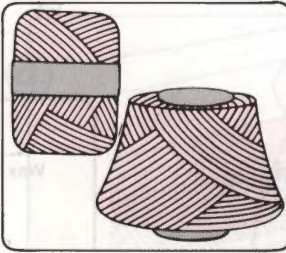

These yarns are suitable for use without rewinding.

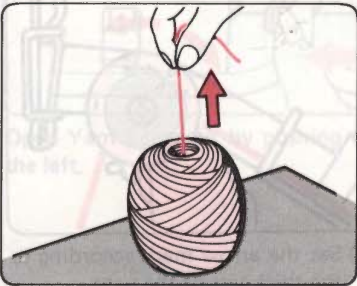
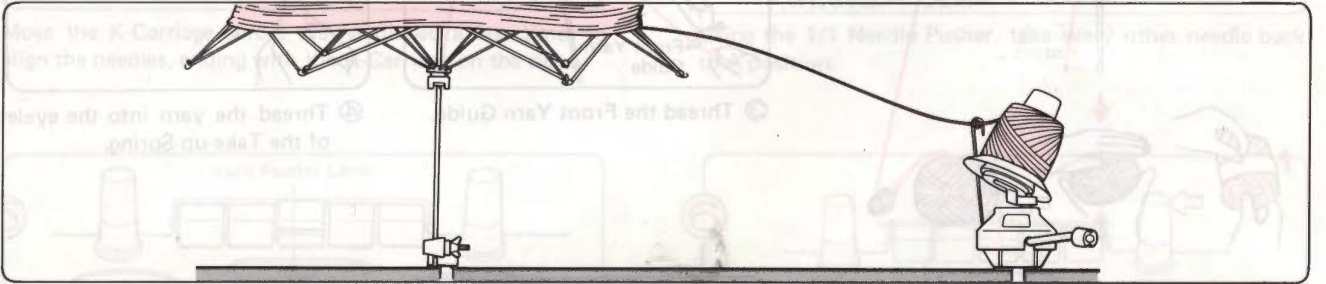

Yarn pulled from the centre of a rewound ball should come out freely without lifting the ball from the table.

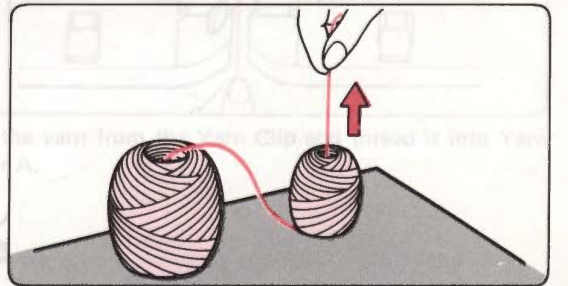
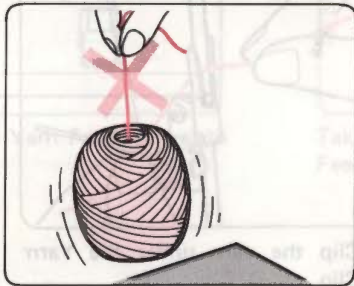

If the yarn does not flow freely, pull some yarn out of the centre of the ball.

Skein Holder

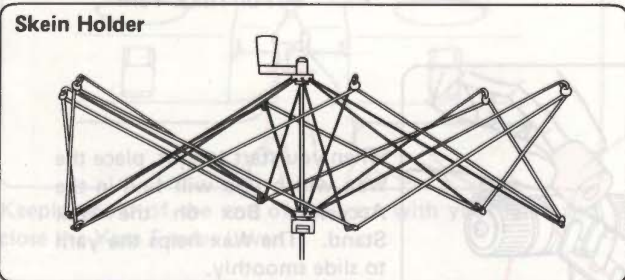

Yarn Winder

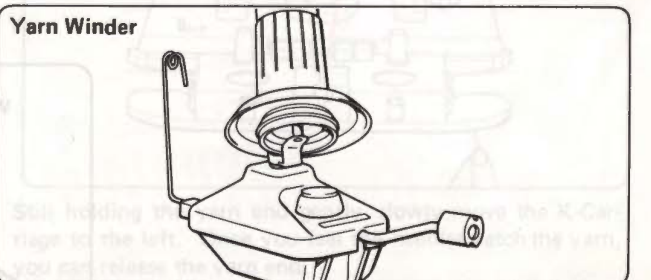

Both the SKEIN HOLDER and YARN WINDER can be purchased separately.

# HOW TO OPERATE YOUR KNITTING MACHINE

## STOCKING STITCH (Plain Knitting)

Stocking stitch is the most basic and simplest stitch in machine knitting. Practice this until you can do it correctly.

### 1. THREADING THE YARN.

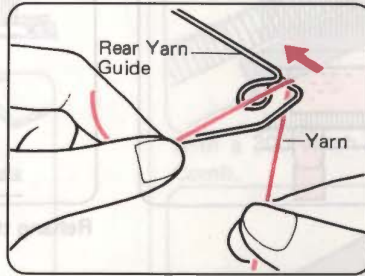
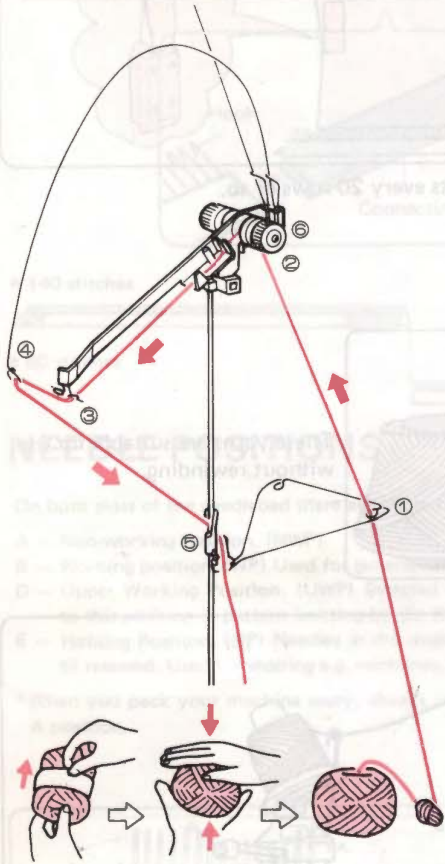

① Pass the yarn from the ball through the Rear Yarn Guide sliding the yarn through the eyelet.

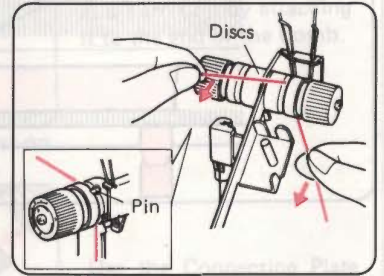

② Pass the yarn under the Pin and between the two Discs from behind. Hold the yarn as shown above, and pull it towards you so that the yarn goes under the Pin.

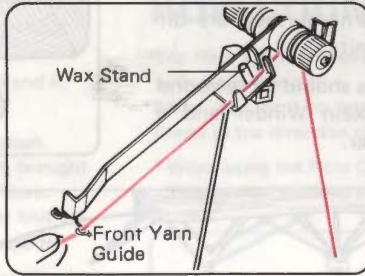

③ Thread the Front Yarn Guide.

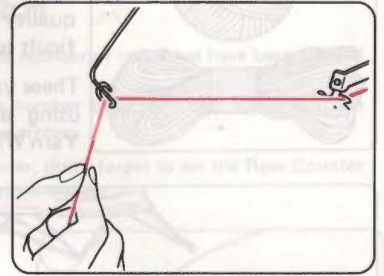

④ Thread the yarn into the eyelet of the Take-up Spring.

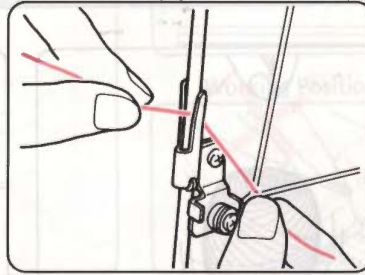

⑤ Clip the yarn under the Yarn Clip.

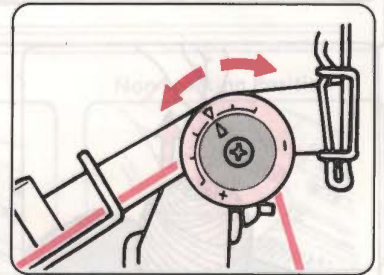

⑥ Set the arrow mark according to the thickness of the yarn.

- ▶ ◀ - For Medium Yarn
- ▶ + - For Fine Yarn
- ▶ - - For Thick Yarn

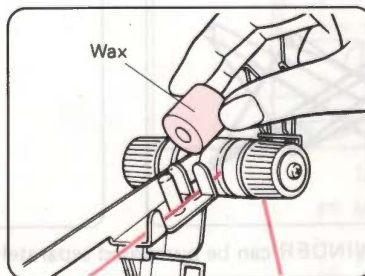

When you start to knit, place the Wax which you will find in the Accessory Box on the Wax Stand. The Wax helps the yarn to slide smoothly.

## 2. HOW TO CAST ON WITH A FINISHED EDGE

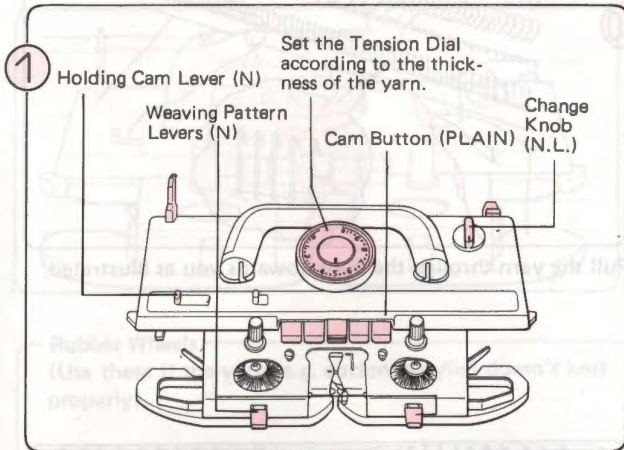

Set the K-Carriage as shown above.

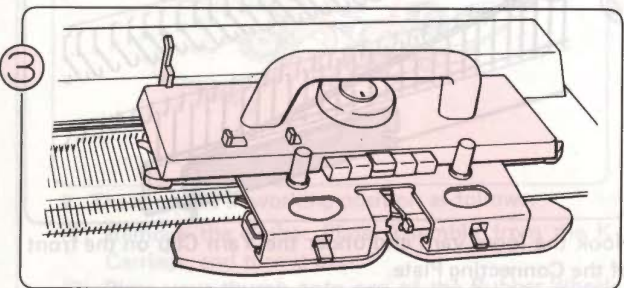

Move the K-Carriage across the needlebed a few times to align the needles, ending with the K-Carriage on the right.

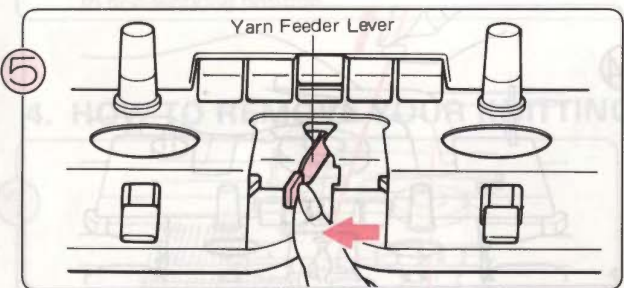

Open Yarn Feeder A by pushing the Yarn Feeder Lever to the left.

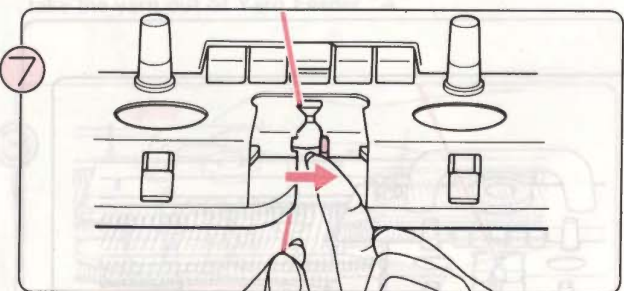

Keeping hold of the end of the yarn with your left hand, close the Yarn Feeder Lever.

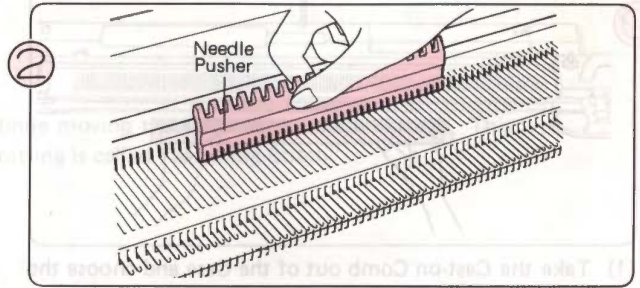

Using the flat side of the 1/1 Needle Pusher, bring forward 60 needles to B position (30 needles on either side of the centre mark "0").

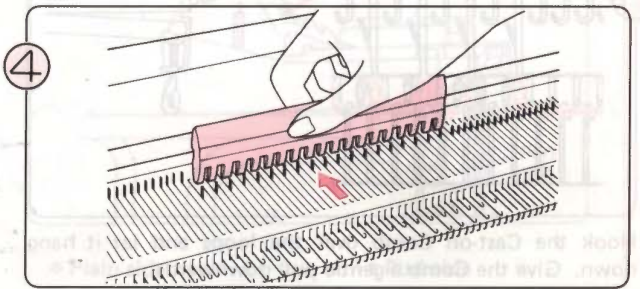

Using the 1/1 Needle Pusher, take every other needle back to A position.

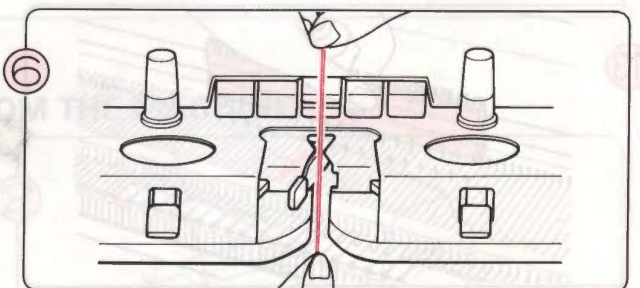

Take the yarn from the Yarn Clip and thread it into Yarn Feeder A.

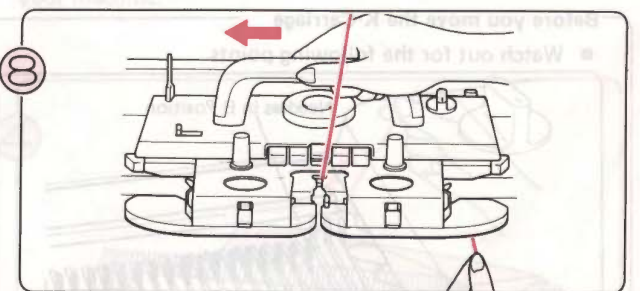

Still holding the yarn end gently, slowly move the K-Carriage to the left. Once you feel the needles catch the yarn, you can release the yarn end.

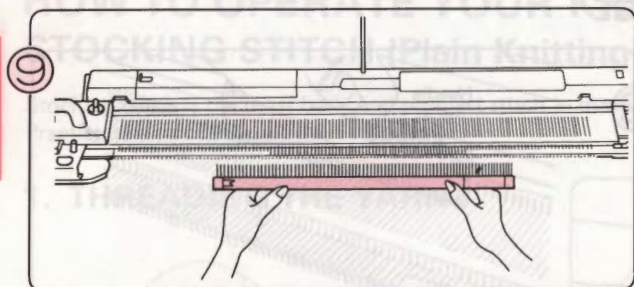

- (1) Take the Cast-on Comb out of the Case and choose the length according to the number of needles.
- (2) Hold the Cast-on Comb as shown with the hooks facing the machine.

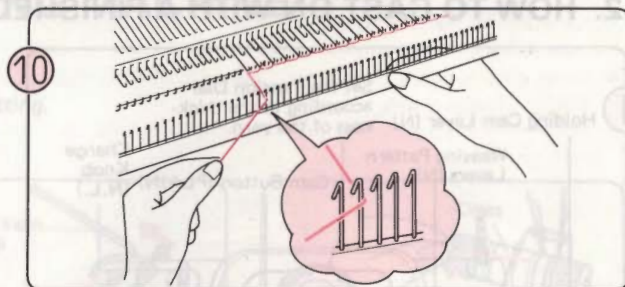

Pull the yarn through the hook towards you as illustrated.

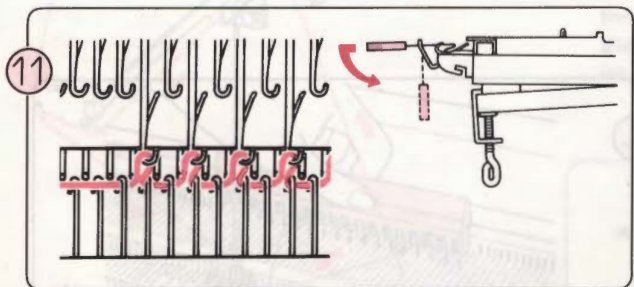

Hook the Cast-on Comb over the loops and let it hang down. Give the Comb a gentle pull downwards.

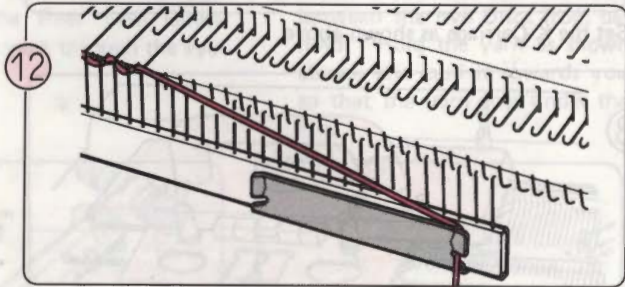

Hook the loose yarn end under the Yarn Clip on the front of the Connecting Plate.

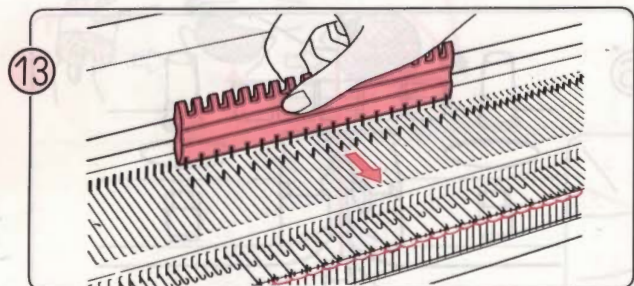

Return the needles which you took to A position in Step 4 forward to B position.

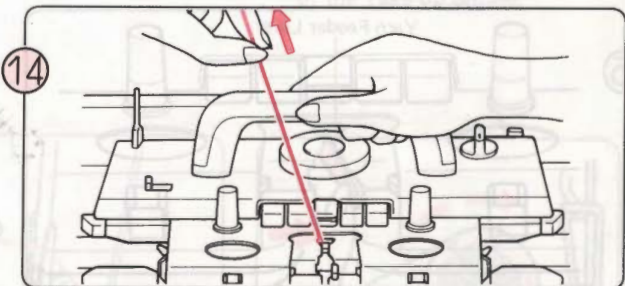

Move the K-Carriage to the right, holding the yarn as shown so that no loops are formed.

**Before you move the K-Carriage**

- Watch out for the following points

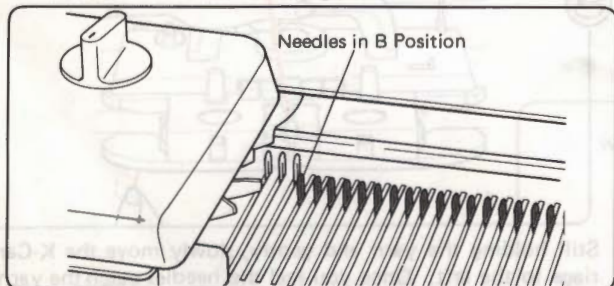

Make sure the K-Carriage (or the L-Carriage) clears the knitting before you move it back in the other direction. You will hear a "Click" at the end of a row.

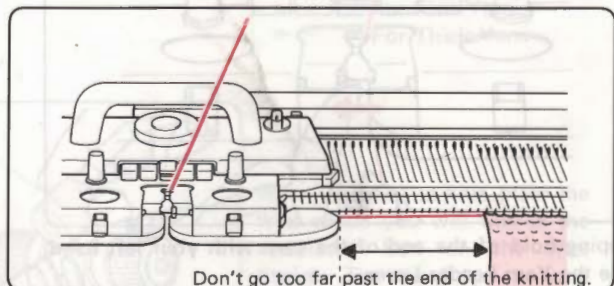

Don't go too far past the end of the knitting. Do not move the K-Carriage too far beyond the knitting.

### 3. STOCKING STITCH

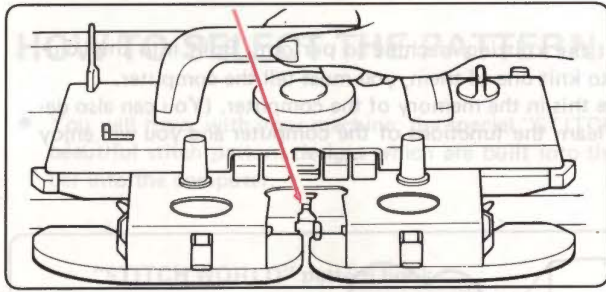

Continue moving the K-Carriage back and forth. This type of knitting is called "Stocking Stitch".

#### Rubber Wheels

(Use these if the yarn (e.g. cotton, acrylic) doesn't knit properly).

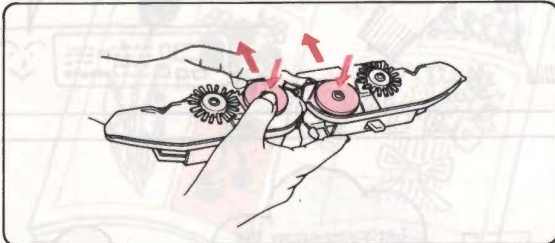

- These are set in working position as follows:
  - (1) Remove the Sinker Plate Assembly from the K-Carriage, and turn it over.
  - (2) Place your thumb onto one of the Rubber Wheels and slide the Wheel forward, so that it is in line with the Brush. Do the same for the other Rubber Wheel.
- \* Reverse the above action to return the Rubber Wheels to non-working position.

#### Plain & Purl Sides of your Knitting

- You can use whichever side you prefer as the right (face) side when you sew up your garment.

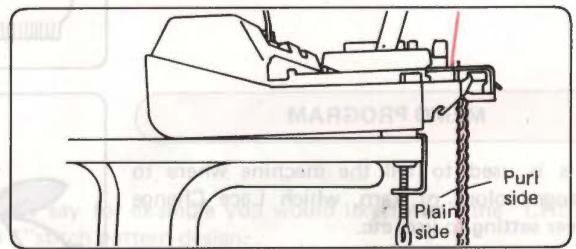

• Plain side

• Purl side



### 4. HOW TO REMOVE YOUR KNITTING FROM THE MACHINE

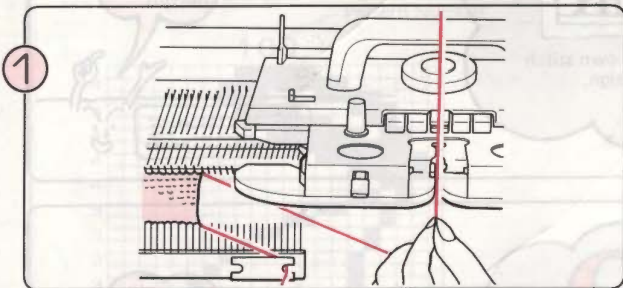

With K-Carriage at the right, remove the Claw Weights and take the yarn out of Yarn Feeder "A".

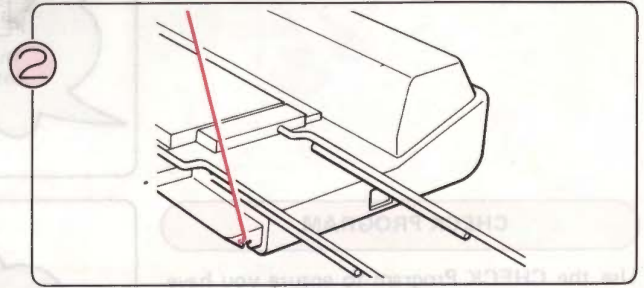

Secure the yarn by hooking it into the slot at the edge of your machine.

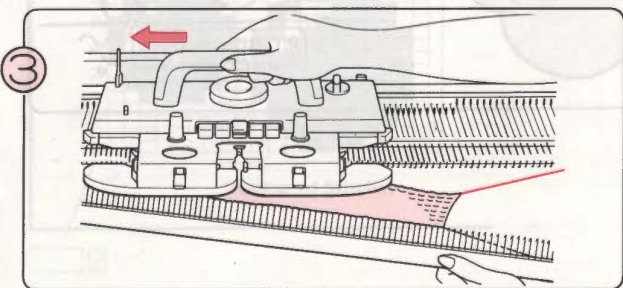

To release the knitting, move the empty K-Carriage slowly across the needles, at the same time supporting the knitting with your other hand.

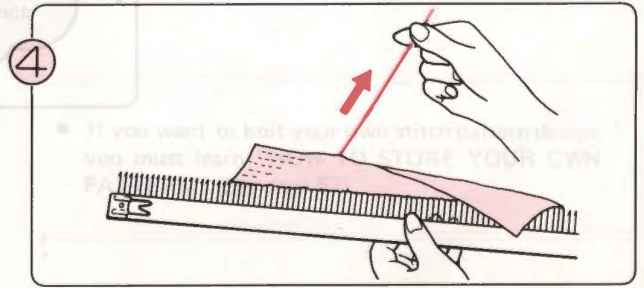

As the knitting has not been finished off and the stitches are open loops, it will unravel easily.



# HOW TO PROGRAM

## PROGRAM

### WHAT IS A PROGRAM?

- PROGRAM means telling the computer what functions you want the knitting machine to perform. Built into the computer memory are 555 different stitch pattern designs, so in order to knit one of them, you must tell the computer. Should you want to design your own stitch pattern, you must store this in the memory of the computer. (You can also delete this information when it is no longer needed). Take time to learn the functions of the computer and you will enjoy your knitting machine to the full.

#### PATTERN PROGRAM

When you want the machine to knit a particular stitch pattern, you must enter this information by using the Pattern Program.

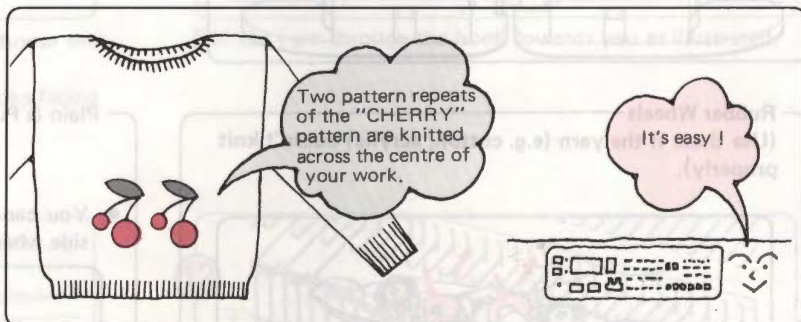

#### MEMO PROGRAM

This is used to tell the machine where to change colour of yarn, which Lace Change Lever setting to use, etc.

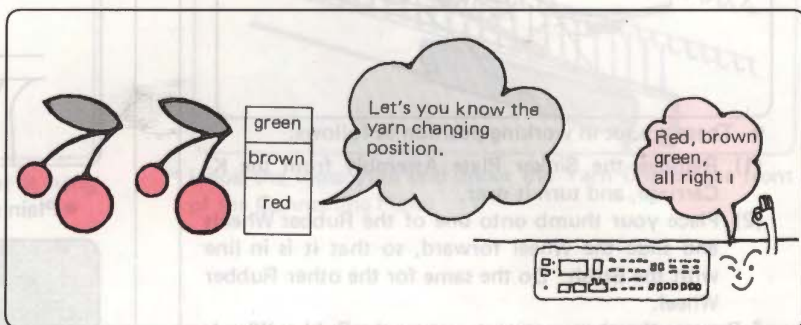

#### INPUT PROGRAM

When you want to enter your own stitch pattern design, use the INPUT Key. (You can also delete it).

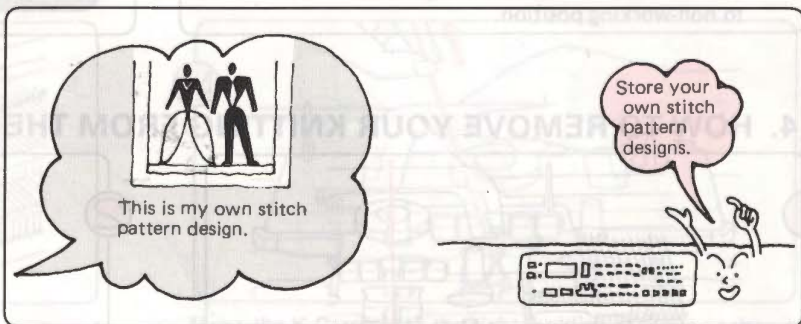

#### CHECK PROGRAM

Use the CHECK Program to ensure you have entered all the information correctly.

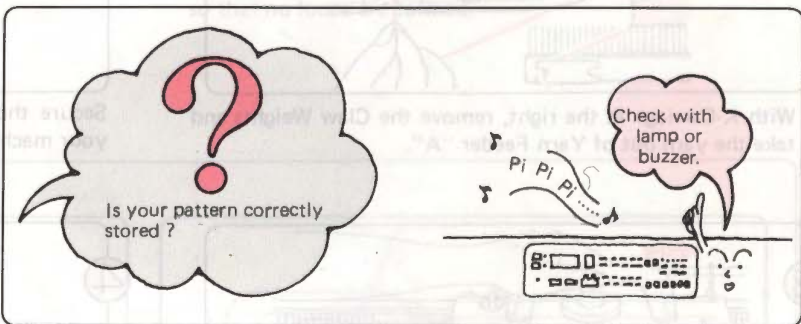

# PATTERN NUMBER

## HOW TO SELECT THE PATTERN

- You will have, with your machine, the special "STITCH WORLD" book. "STITCH WORLD" shows in full colour the 555 beautiful stitch pattern designs which are built into the memory of the computer. Choose your design and enter the number into the computer.

"STITCH WORLD" pattern book



Let's say for example you would like to knit the "CHERRY" stitch pattern design. You should simply enter 100.

- You may want to knit this fairisle design in more than two colours. Should this be the case, refer to the back section of "STITCH WORLD" where all the designs are clearly shown by graph, giving width and length of one pattern repeat, and showing where the yarn changes appear.

### DIAGRAM SHOWING ONE PATTERN REPEAT OF A STITCH PATTERN DESIGN

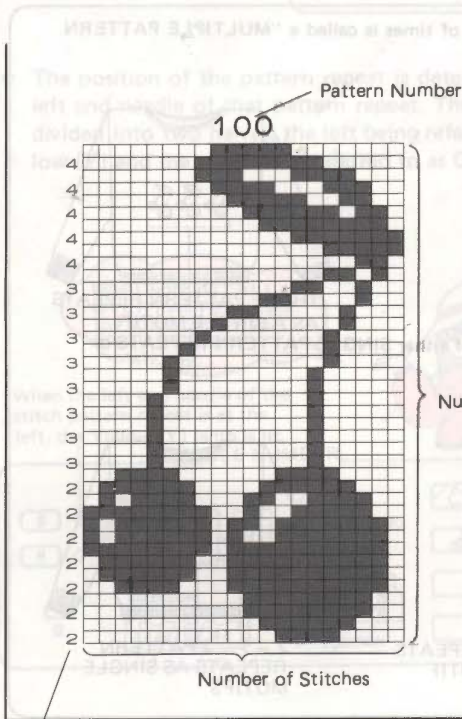

- If you want to knit your own stitch pattern design, you must learn "HOW TO STORE YOUR OWN PATTERN" (See page 57).

The number of contrast yarn is shown in the Memo Display.

# SELECTORS

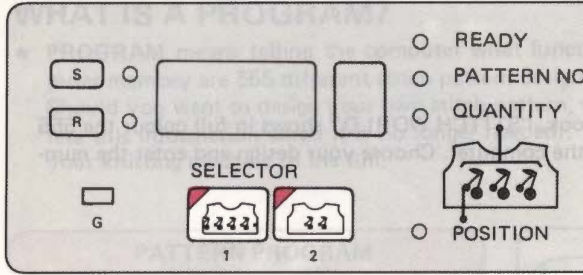

● There are two "SELECTORS" on the panel. You have to decide which one you want to use.

## ● SELECTOR (1)



All-over patterning. (Refer to page 22.)

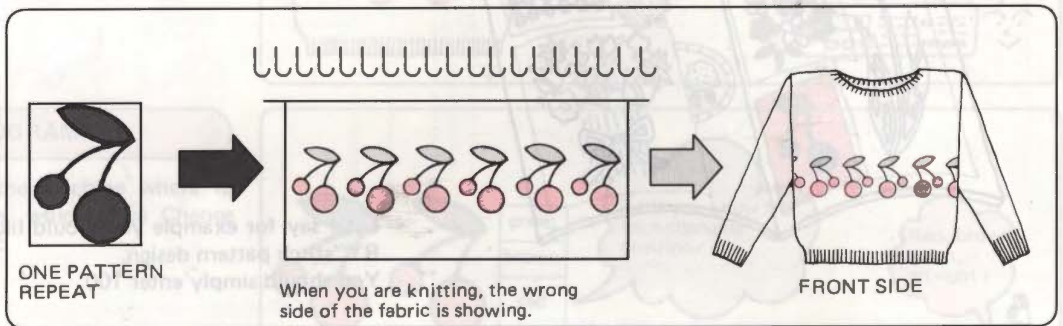

## ● SELECTOR (2)

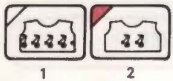

A number of pattern repeats specifically positioned. (Refer to page 28.)

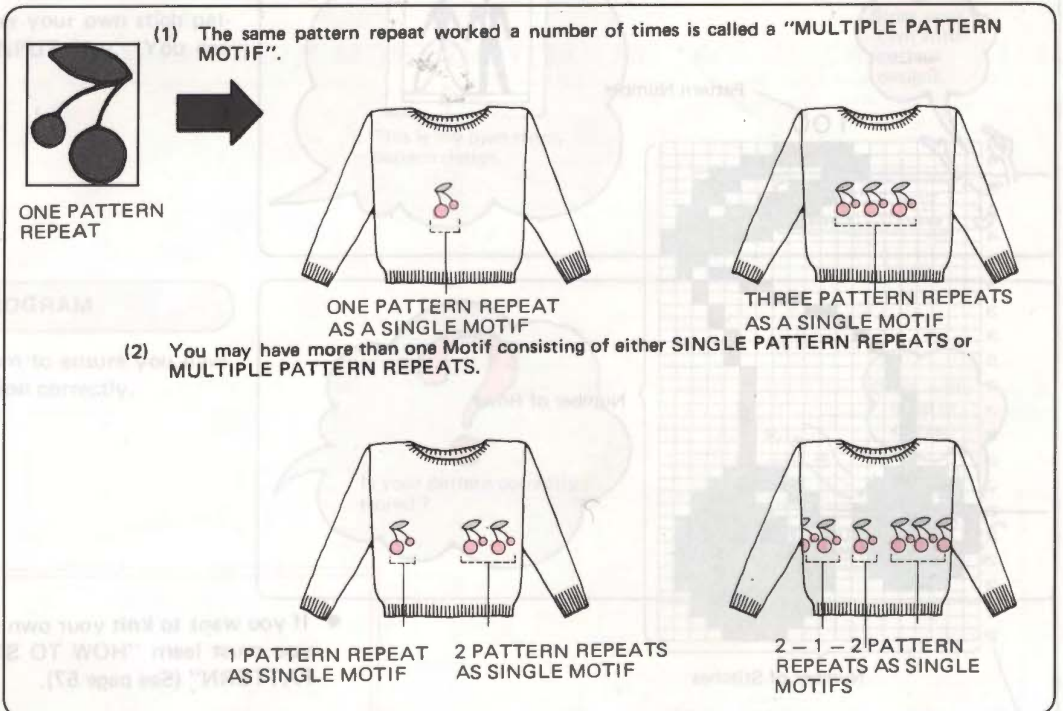

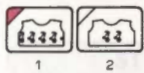

# ALL OVER PATTERNING USE SELECTOR (1) (Pattern A)

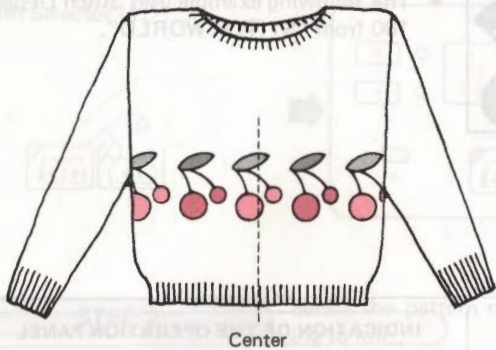

★ When you program for an all over pattern, the pattern repeat is placed over the centre of the needlebed.

- When you have chosen SELECTOR (1) you simply enter the number of the Stitch Pattern Design and machine will automatically knit the pattern repeat, placed over the centre of the needlebed, as an all over stitch design.

Pattern No. 100



20 Stitches

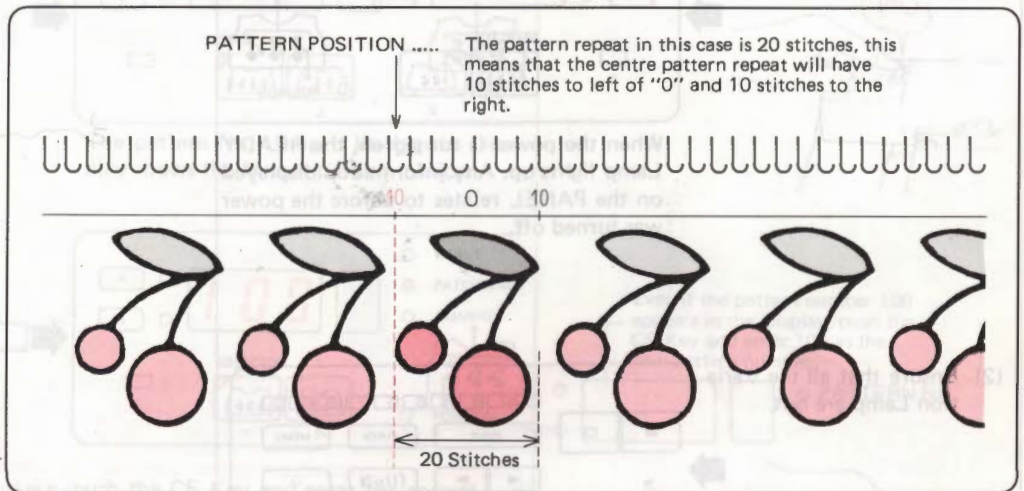

- The position of the pattern repeat is determined by the left end needle of that pattern repeat. The needlebed is divided into two halves, the left being referred to as Yellow (Y) and the right being referred to as Green (G).
- When one pattern repeat consists of an odd number of stitches, the centre needle is automatically placed on G1.

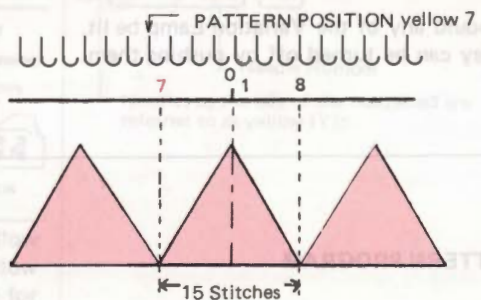

When working "ALL OVER PATTERNING" the stitch pattern repeat is centred automatically.



When the left end needle of the stitch pattern repeat is at the left, the Yellow (Y) lamp is lit.

NEEDLE NUMBER

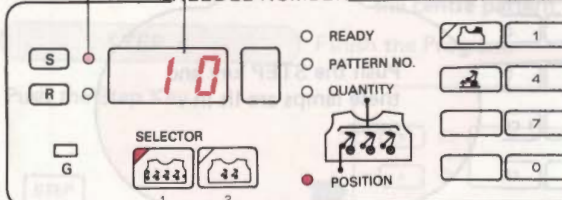

The program for all over patterning is completed when you have entered the pattern number and the position of the left end needle for one stitch pattern repeat.

■ HOW TO PROGRAM (PATTERN PROGRAM)



★ The following example uses Stitch Design, 100 from "STITCH WORLD".

● Before entering your program

(1) Switch on the power.

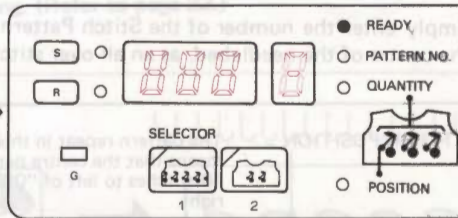
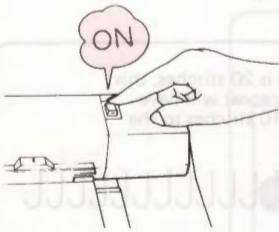

When the power is turned on, the READY Lamp lights up. Any information displayed on the PANEL relates to before the power was turned off.

INDICATION OF THE OPERATION PANEL

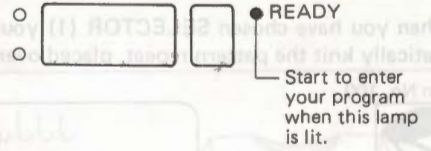

(2) Ensure that all the Variation Lamp are out.

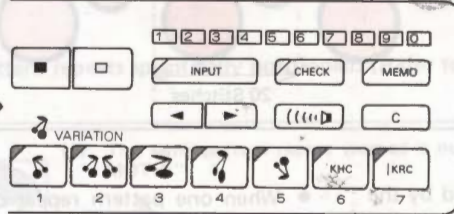
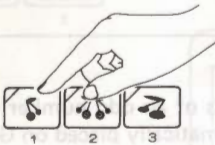

\* Should any of the Variation Lamp be lit, they can be turned off by pushing them.

● PATTERN PROGRAM

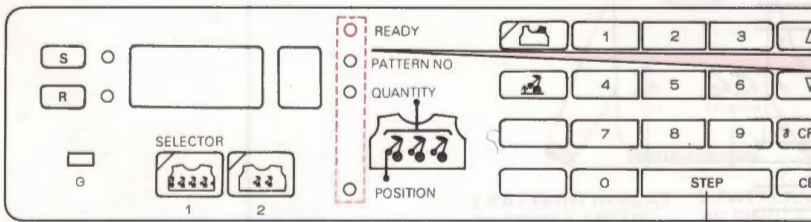

Push the STEP key and these lamps are lit in order.

Step Key

● If you want to return to the beginning of a Program, turn off the power. When the power is switched on again the READY Lamp is lit and you may start at the beginning again.

**INDICATION OF THE OPERATION PANEL**

**STEP 1**

Choose the Selector (1) or (2).

Push Selector (1).

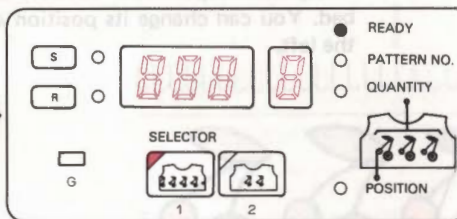
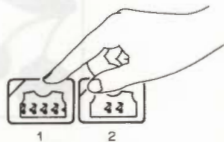

For all over patterning you should push Selector (1).

**STEP 2**

Select the pattern number which you are going to knit.

(1) Push the Step Key.

STEP

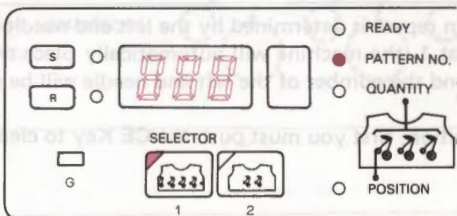

The pattern No. Lamp is lit and the Display shows the former pattern number.

(2) Push the CE Key to clear the Display and enter 100 as the new pattern number.

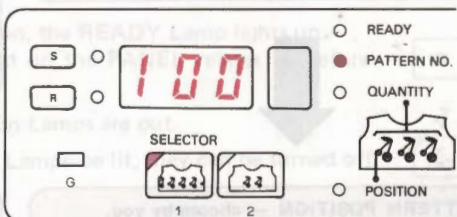
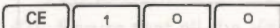

Even if the pattern number 100 appears in the Display, push the CE Key and enter 100 as the new pattern number.

• Should you make a mistake, push the CE Key and enter the correct figure.

**STEP 3**

Check the position of the left end needle of the centre pattern.

Push the Step Key.

STEP

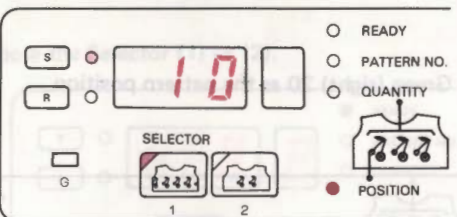

The Position Lamp is lit. The Yellow Lamp and Display indicate that Yellow 10 (Y10) will be the left end needle for the centre pattern.

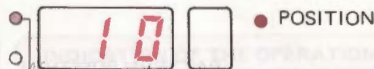

Needles to the left of the needled are referred to as yellow (Y).

**STEP 4**

Finish the Program.

Push the Step Key.

STEP

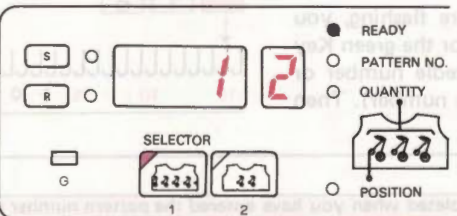

The READY Lamp is lit and you have completed the program.

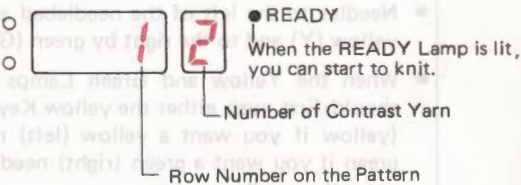

When the READY Lamp is lit, you can start to knit.

• If you want to check what has been programmed in, you can do so by repeatedly pressing the Step Key. The program will be displayed step by step in the order in which you entered it. (See p. 37.)

• To knit the pattern see p. 78.

## USE SELECTOR (1) (Pattern B)

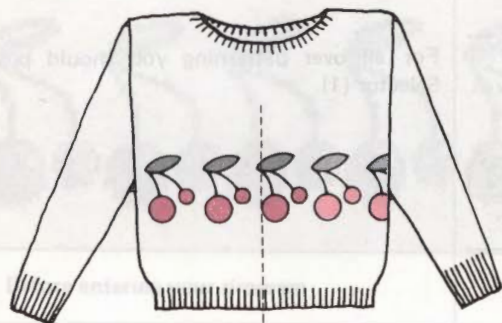
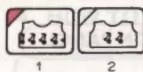

Center

- ★ The pattern repeat does not have to be over the centre of the needlebed. You can change its position and move it to either the right or the left.

Pattern No. 100



◀20 Stitches▶

- ★ The position of the pattern repeat is determined by the left end needle of that pattern repeat.
- ★ When the Selector is set at 1, the machine will automatically place the pattern repeat over the centre of the needlebed, and the number of the left end needle will be shown in the Display.

To change the pattern position, first you must push the CE Key to clear the Display.

PATTERN POSITION  
(set by the computer)

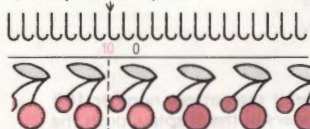

PATTERN POSITION  
set automatically by the computer.

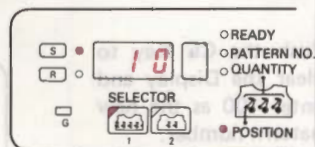

PATTERN POSITION  
(set by you)

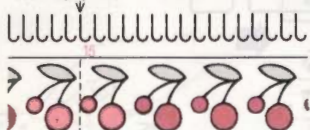

PATTERN POSITION — chosen by you.

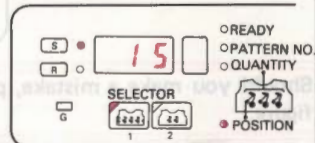

E.G. Enter Yellow (left) 15 as the pattern position.

PATTERN POSITION  
(set by you)

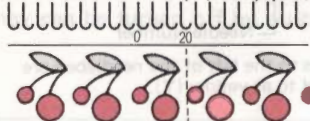

E.G. Enter Green (right) 20 as the pattern position.

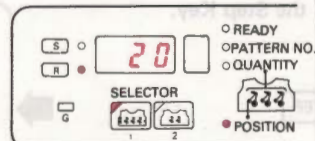

### How to enter the pattern position

- Needles to the left of the needlebed are represented by yellow (Y) and to the right by green (G).
- When the Yellow and Green Lamps are flashing, you should first push either the yellow Key or the green Key (yellow if you want a yellow (left) needle number or green if you want a green (right) needle number). Then enter the needle number.

(Ex.)

Yellow Key 1 5

Green Key 2 0

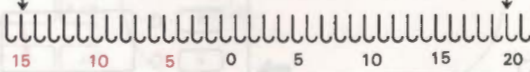

The program for all over patterning is completed when you have entered the pattern number and the position of the left end needle for one stitch pattern repeat.

## ■ HOW TO PROGRAM (PATTERN PROGRAM)

Example: Change the pattern position to yellow 15 from yellow 10.

Pattern No. 100

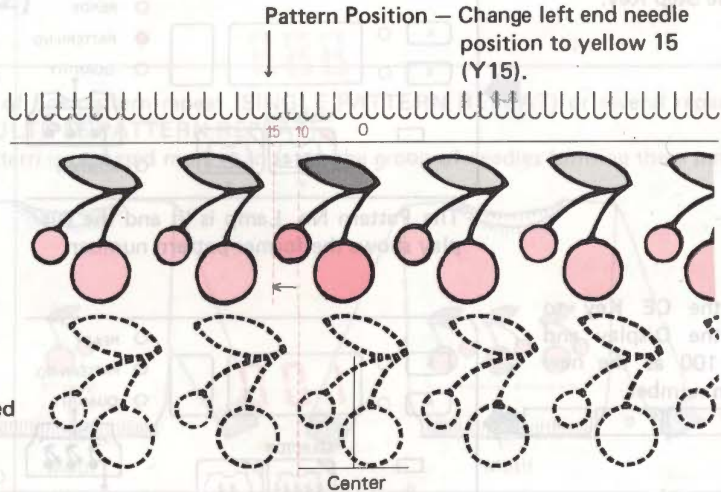

Original pattern position which was placed automatically by the computer.

### ● Before entering your program

(1) Switch on the power.

When the power is turned on, the READY Lamp lights up.  
Any information displayed on the PANEL relates to before the power was turned off.

(2) Ensure that all the Variation Lamps are out.

\*Should any of the Variation Lamps be lit, they can be turned off by pushing them.

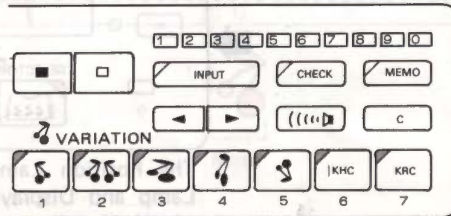

### ● PATTERN PROGRAM

#### STEP 1

Choose the Selector (1) or (2).

Push Selector (1).

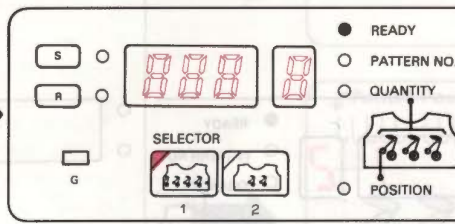
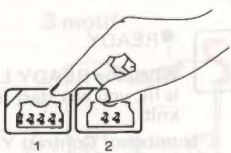

#### INDICATION OF THE OPERATION PANEL

For all over patterning, you should push Selector (1).



## STEP 2

Select the pattern number which you are going to knit.

(1) Push the Step Key.

STEP

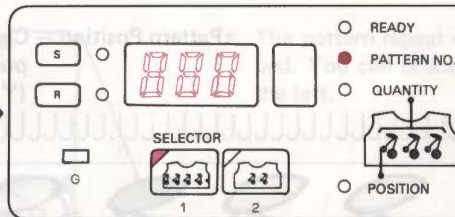

The Pattern No. Lamp is lit and the Display shows the former pattern number.

(2) Push the CE Key to clear the Display and enter 100 as the new pattern number.

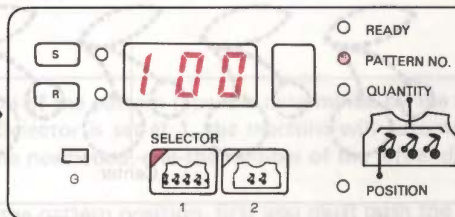
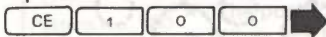

Even if the pattern number 100 appears in the Display push the CE Key and enter 100 as the new pattern number.

## STEP 3

Check the position of the left end needle of the centre pattern.

(1) Push the Step Key.

STEP

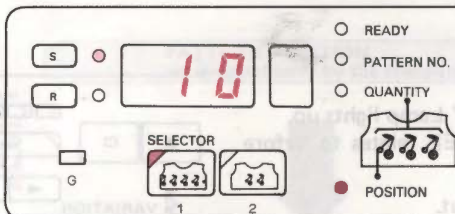

The Position Lamp is lit. The Yellow Lamp and Display indicate that Yellow 10 (Y10) will be the left end needle for the centre pattern.

(2) Push the CE Key to clear the Display and enter Yellow 15 as the new left end needle position.

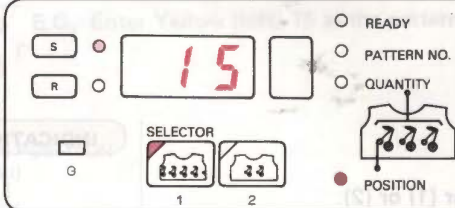

Needle Number  
Needles to the left of the needlebed are referred to as yellow (Y).

## STEP 4

Finish the Program.

Push the Step Key.

STEP

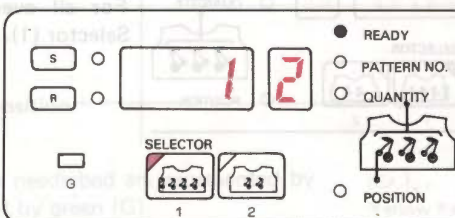

The READY Lamp is lit and you have completed the program.

When the READY Lamp is lit, you can start to knit.  
Number of Contrast Yarn.  
Row Number on the Pattern.

- If you want to check what has been programmed in, you can do so by repeatedly pressing the Step Key. The program will be displayed step by step in the order in which you entered it. (See p. 37.)

\* To knit the pattern see p. 78.

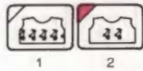

# MOTIFS

## USE SELECTOR (2)

### ■ MULTIPLE PATTERN MOTIF

#### ● What are "Multiple Pattern Motifs" ?

- A motif can consist of one pattern repeat (SINGLE PATTERN REPEAT) or several repeats of the same pattern (MULTIPLE PATTERN REPEAT). Even though the pattern is repeated more than once, the group of needles forming these patterns still make a motif.

Pattern No. 100

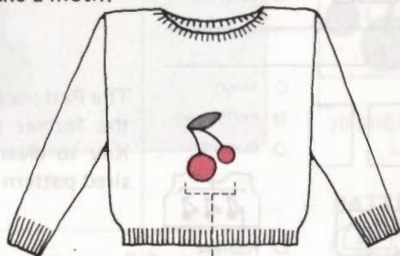

Motif

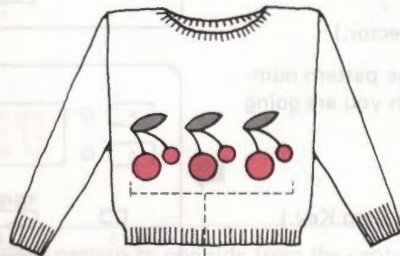

Motif

- Using Selector (2) you can have various combinations of single and multiple pattern repeat motifs.

1 motif

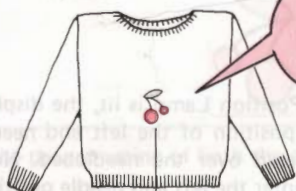

Motif

During knitting the reverse side of your work is facing you.

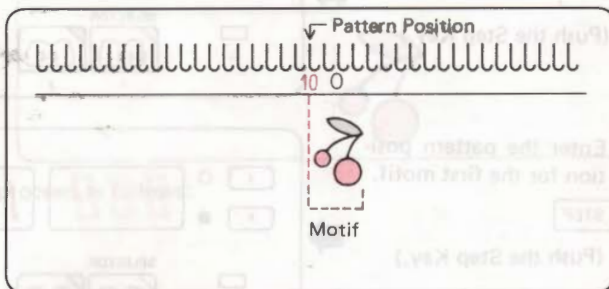

2 motif

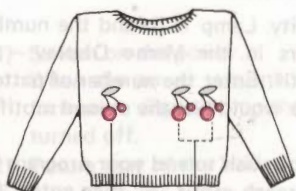

Motif

Motif

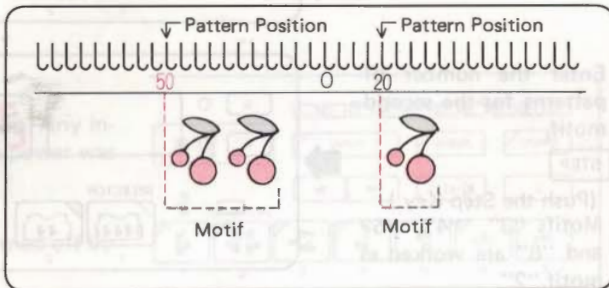

3 motif

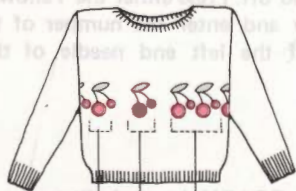

Motif

Motif

Motif

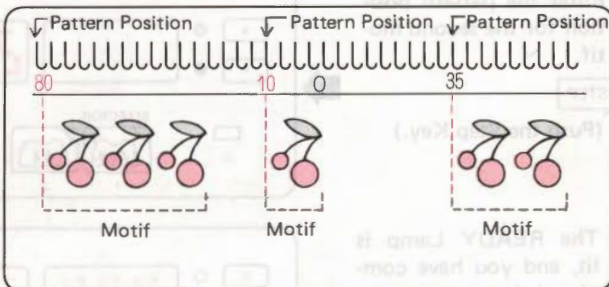

- The motifs are numbered according to the order in which you enter them, i.e. first, second, third, etc.

## PATTERN PROGRAM

Selector (2) is used for 1, 2, 3, 4, 5 and 6 pattern motifs.

- (1) Choose the Selector (2).

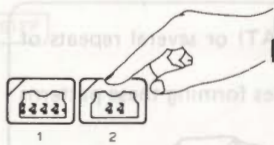

(Push Selector.)

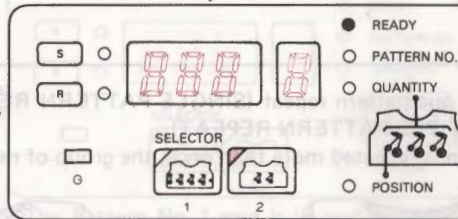

- (2) Select the pattern number which you are going to knit.

STEP

(Push the Step Key.)

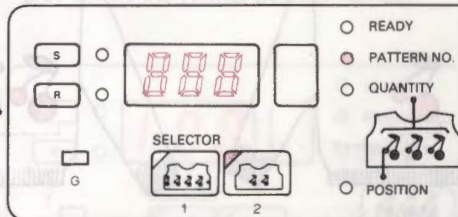

The Pattern No. is lit and the display shows the former pattern number. Push the CE Key to clear the display and enter the desired pattern number.

- (3) Enter the number of patterns for the first motif.

STEP

(Push the Step Key.)

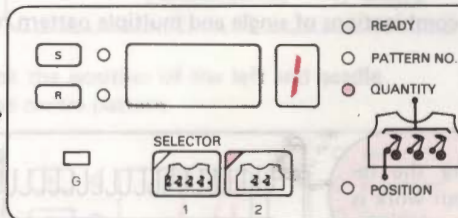

When the Quantity Lamp is lit, "1" appears in the Memo Display – the first motif. Enter the number of pattern repeats you would like the first motif to have.

- (4) Enter the pattern position for the first motif.

STEP

(Push the Step Key.)

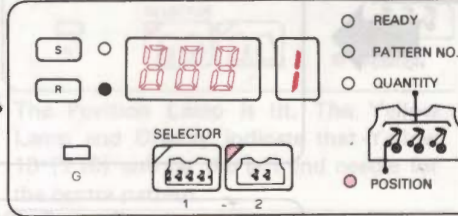

When the Position Lamp is lit, the display shows the position of the left end needle when centered over the needlebed. Now you must enter the left end needle position required by pressing the CE Key. The Yellow and Green Lamps will flash on and off. Press either the Yellow or Green Key and enter the number of the new position of the left end needle.

- (5) Enter the number of patterns for the second motif.

STEP

(Push the Step Key.)  
Motifs "3", "4", "5" and "6" are worked as motif "2".

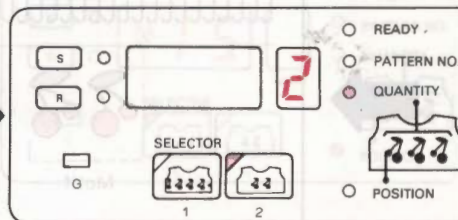

The Quantity Lamp is lit and the number "2" appears in the Memo Display – the second motif. Enter the number of pattern repeats you would like the second motif to have.

\*Should you wish to end your program before you reach motif "6" then enter "0".

- (6) Enter the pattern position for the second motif.

STEP

(Push the Step Key.)

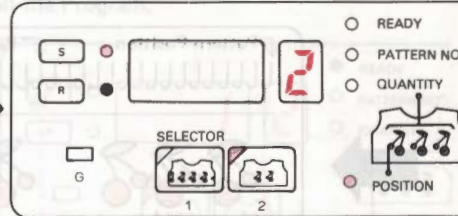

When the Position Lamp is lit for the second motif, the Yellow and Green Lamps flash on and off. Press either the Yellow or Green Key and enter the number of the position of the left end needle of that motif.

- (7) The READY Lamp is lit, and you have completed the program.

STEP

(Push the Step Key.)

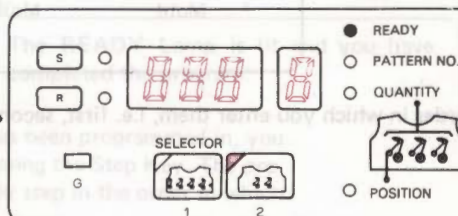

When the READY Lamp is lit, you may start to knit.

The program for Multiple Pattern Motifs is completed when you have entered the pattern number, the number of pattern repeats in each motif and the position of the motifs.

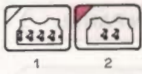

# MOTIFS - ONE PATTERN REPEAT AS A SINGLE MOTIF USE SELECTOR (2)

## ■ Motif with single pattern repeat



- The following example uses Stitch Pattern 100 from "STITCH WORLD".

### PATTERN A

Ex.

- ★ Knit a pattern in the centre of the needlebed.

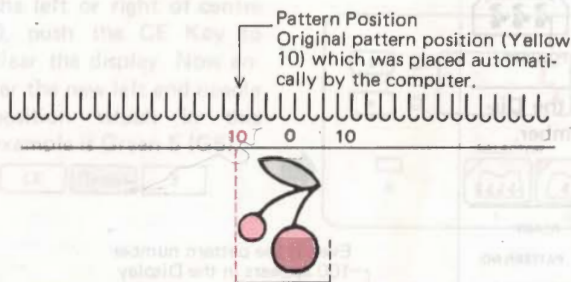

### PATTERN B

Ex.

- ★ Move the pattern to one side from the centre. Change the position from Yellow 10 (placed automatically by the computer) to Green 5. (G5)

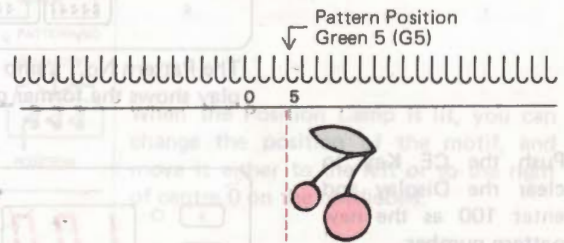

\*The programming of both the above patterns is identical, so proceed as follows:

## ● Before entering your program

- (1) Switch on the power.  
When the power is turned on the READY Lamp lights up. Any information displayed on the PANEL relates to before the power was turned off.

- (2) Ensure that all the Variation Lamps are out.

\*Should any of the Variation Lamps be lit, they can be turned off by pushing them.

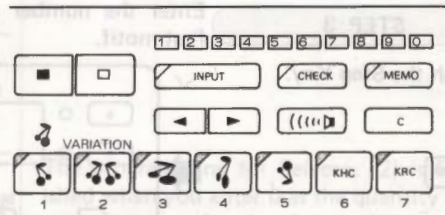

● **PATTERN PROGRAM**

**INDICATION OF THE OPERATION PANEL**

**STEP 1**

Choose the Selector (1) or (2).

Push Selector (2).

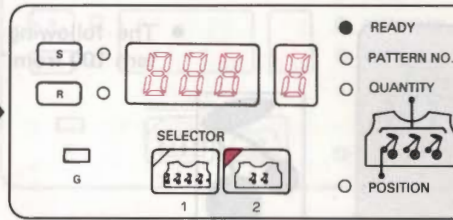
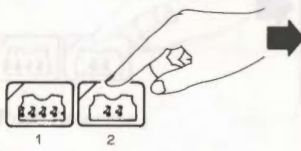

Choose Selector (2) because you want to knit Multiple Pattern Motifs.

**STEP 2**

Select the pattern number which you are going to knit.

(1) Push the Step Key.

STEP

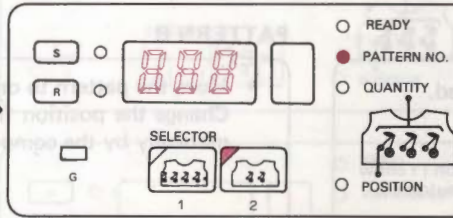

The Pattern No. Lamp is lit and the Display shows the former pattern number.

(2) Push the CE Key to clear the Display and enter 100 as the new pattern number.

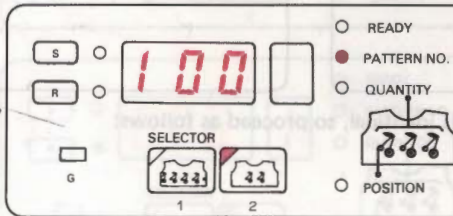
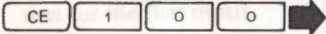

Even if the pattern number 100 appears in the Display push the CE Key and enter 100 as the new pattern number.

**STEP 3**

Enter the number of pattern repeats in the first motif.

(1) Push the Step Key.

STEP

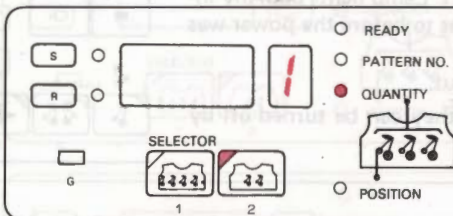

When the Quantity Lamp is lit, the computer wants to know how many pattern repeats there are in the first motif.

● **PATTERN NO.**

● **QUANTITY**

This indicates that you are programming the first motif.

(2) Enter 1.

1

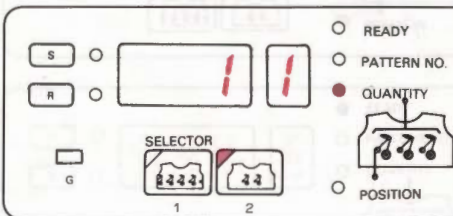

● **QUANTITY**

This indicates that you are programming the first motif. Pattern repeats entered by you.

**STEP 4**

Enter the pattern position for first motif.

(1) Push the Step Key.

STEP

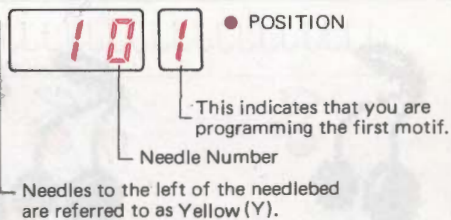
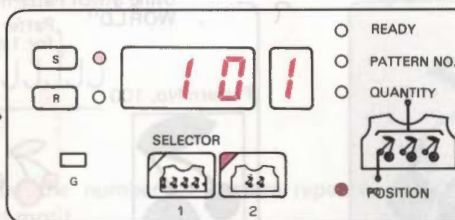

(2) ● PATTERN A

If you want to knit the pattern centered at 0, then proceed to Step 5.

● PATTERN B

If you want to change the position of the pattern to the left or right of centre 0, push the CE Key to clear the display. Now enter the new left end needle position which in this example is Green 5 (G5).

The Position Lamp is lit. The Yellow Lamp and Display indicate that Yellow 10 (Y10) will be the left end needle for the first motif. (Pattern will be centered over 0 on the needlebed).

CE Green 5

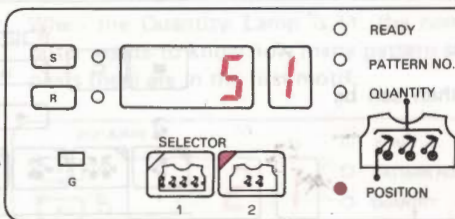

When the Position Lamp is lit, you can change the position of the motif, and move it either to the left or to the right of centre 0 on the needlebed.

**STEP 5**

Now enter the number of pattern repeats in the second motif.

(1) Push the Step Key.

STEP

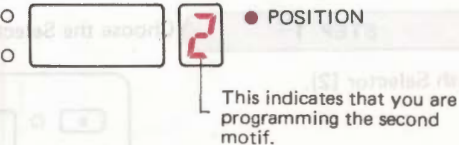
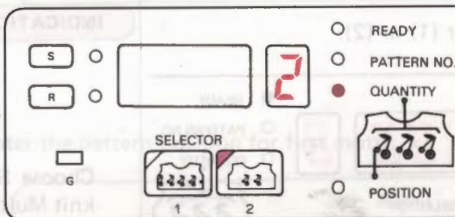

When the Quantity Lamp is lit, the computer wants to know how many pattern repeats there are in the second motif.

(2) Enter 0.

0

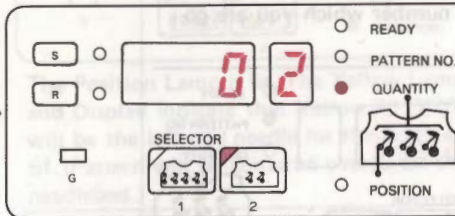

The programming for Selector (2) is finished when you enter 0 as the quantity of pattern repeats for the next motif.

**STEP 6**

End of program

Push the Step Key.

STEP

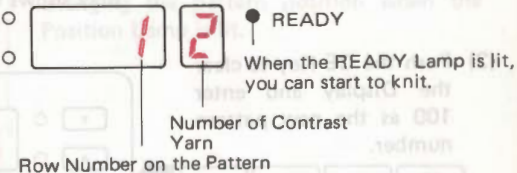
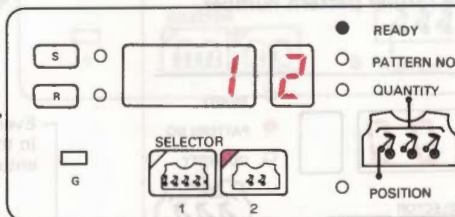

The READY Lamp is lit, and you have completed the program. You are now ready to knit !.

\* To knit the pattern see p. 80.

- If you want to check what you have programmed in, you can do so by repeatedly pressing the Step Key. The program will be displayed step by step in the order in which you entered it. (See page 38.)

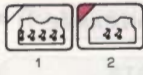

# MOTIFS - TWO PATTERN REPEATS AS MOTIF 1 AND ONE PATTERN REPEAT AS MOTIF 2 USE SELECTOR (2)

## ■ Motif with multiple pattern repeats

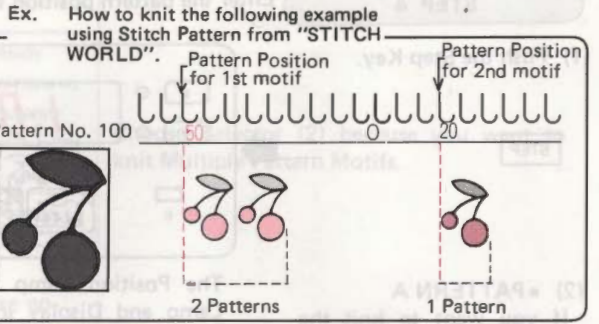

## ● Before entering your program

- Switch on the power.  
When the power is turned on the READY Lamp lights up. Any information displayed on the PANEL relates to before the power was turned off.
- Ensure that all the Variation Lamps are out.

\*Should any of the Variation Lamps be lit, then can be turned off by pushing them.

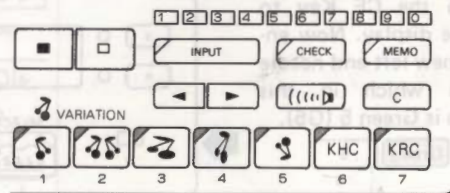

## ● PATTERN PROGRAM

### STEP 1

Choose the Selector (1) or (2).

Push Selector (2).

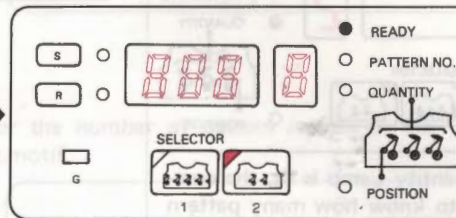
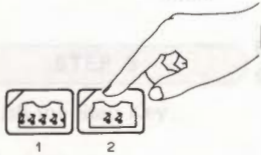

### INDICATION OF THE OPERATION PANEL

Choose Selector (2) because you want to knit Multiple Pattern Motifs.

### STEP 2

Select the pattern number which you are going to knit.

- Push the Step Key.

STEP

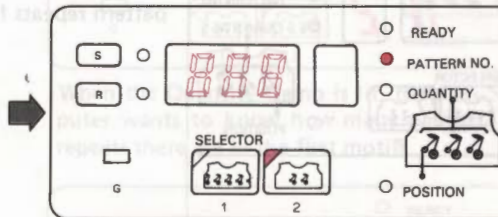

The Pattern No. Lamp is lit and the Display shows the former pattern number.

- Push the CE Key to clear the Display and enter 100 as the new pattern number.

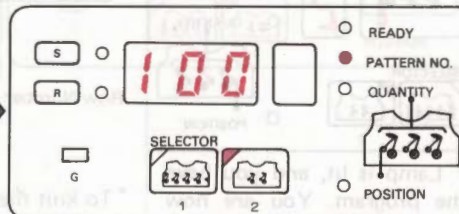
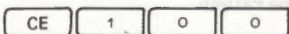

Even if the pattern number 100 appears in the Display push the CE Key and enter 100 as the new pattern number.

### STEP 3

Enter the number of pattern repeats in the first motif.

(1) Push the Step Key.

STEP

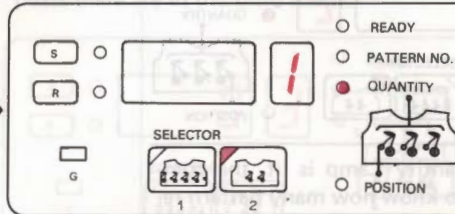

When the Quantity Lamp is lit, the computer wants to know how many pattern repeats there are in the first motif.

(2) Enter 2.

2

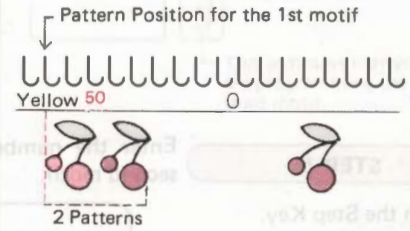
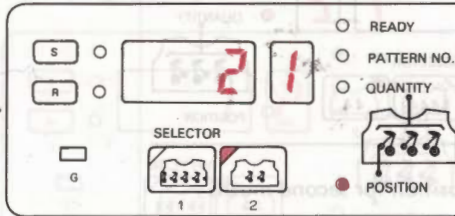

This indicates that you are programming the first motif.



This indicates that you are programming the first motif. Pattern repeats entered by you.

### STEP 4

Enter the pattern position for first motif.

(1) Push the Step Key.

STEP

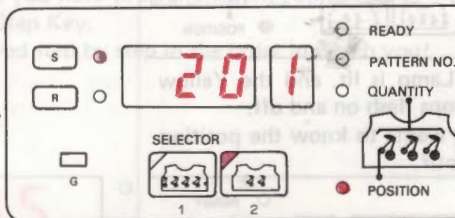

The Position Lamp is lit. The Yellow Lamp and Display indicate that Yellow 20 (Y20) will be the left end needle for the first motif. (Pattern will be centered over 0 on the needlebed.)



This indicates that you are programming the first motif. Needle Number

Needles to the left of the needlebed are referred to as yellow (Y).

(2) Push the CE Key to clear the Display and enter Yellow 50 (Y50) as the new left end needle position.

CE Yellow 5 0

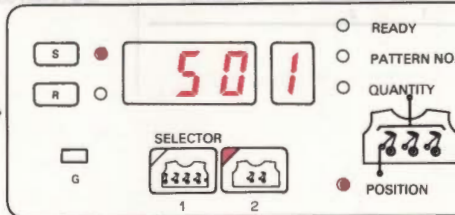

The computer automatically sets the pattern position for the 1st motif so that it is centered.

You can move this motif to one side by changing the pattern position when the Position Lamp is lit.



# MOTIFS - TWO PATTERN REPEATS AS MOTIF 1 AND ONE PATTERN REPEAT AS MOTIF 2 USE SELECTOR (2)

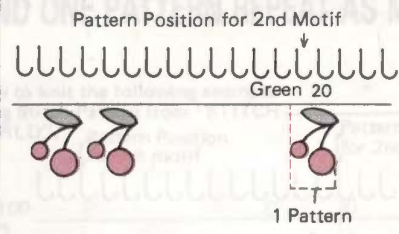

## STEP 5

Enter the number of pattern repeats in the second motif.

(1) Push the Step Key.

STEP

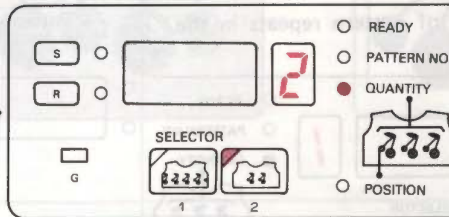

READY  
PATTERN NO.  
● QUANTITY  
POSITION

2 ● QUANTITY

This indicates that you are programming the second motif.

When the Quantity Lamp is lit, the computer wants to know how many pattern repeats there are in the second motif.

(2) Enter 1.

1

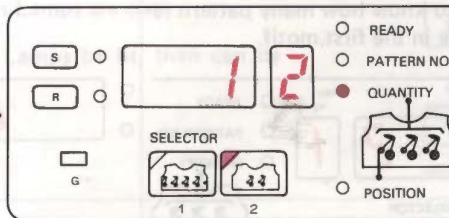

READY  
PATTERN NO.  
● QUANTITY  
POSITION

1 2 ● QUANTITY

This indicates that you are programming the second motif.  
Pattern repeats entered

## STEP 6

Enter the pattern position for second motif.

(1) Push the Step Key.

STEP

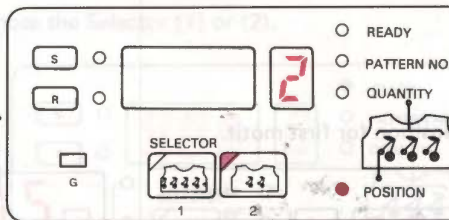

READY  
PATTERN NO.  
QUANTITY  
● POSITION

2 ● POSITION

This indicates that you are programming the second motif.

The Position Lamp is lit, and the Yellow and Green Lamps flash on and off. The computer wants to know the position for the 2nd motif.

(2) Enter Green 20 (G20) for the pattern position of the 2nd motif.

Green 2 0

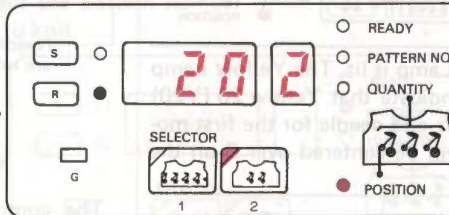

READY  
PATTERN NO.  
QUANTITY  
● POSITION

20 2 ● POSITION

This indicates that you are programming the second motif.  
Needle Number

Needles to the right of the needlebed are referred to as green (G).

### STEP 7

Enter the number of pattern repeats in the 3rd motif.

(1) Push the Step Key.

STEP

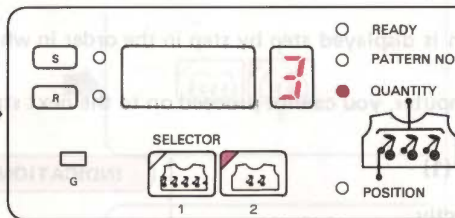

When the Quantity Lamp is lit, the computer wants to know how many pattern repeats there are in the third motif.



POSITION

This indicates that you are programming the third motif.

(2) Enter 0.

0

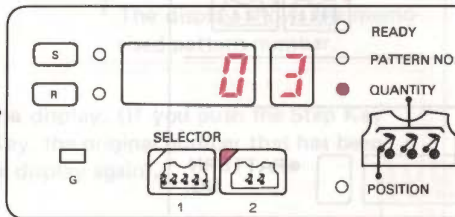

The programming for Selector 2 is finished when you enter 0 as the number of pattern repeats for the next motif.

### STEP 8

Finish the programming.

Push the Step Key.

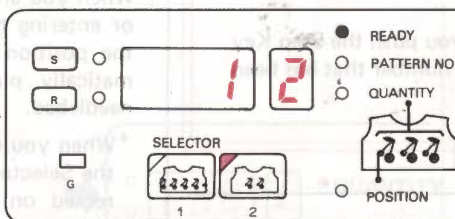

When the READY Lamp is lit, you can start to knit.

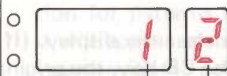

READY

The READY Lamp is lit, and you have completed the program.

Number of Contrast Yarn

Row Number on the Pattern

- If you want to check what you have programmed in, you can do so by repeatedly pressing the Step Key. The program will be displayed step by step in the order in which you entered it. (See p. 38.)

\*To knit the pattern see p. 80.

# HOW TO CHECK AND CORRECT YOUR PATTERN PROGRAM

If you repeatedly push the Step Key, the program is displayed step by step in the order in which you entered it. In this way you can check and correct your program.

- If there is no pattern programmed into the computer, you cannot proceed on to the next stage even if you push the Step Key.

## • How to check the pattern program for Selector (1)

- (1) Make sure that all Variation Keys are set correctly.
- (2) Choose Selector (1).

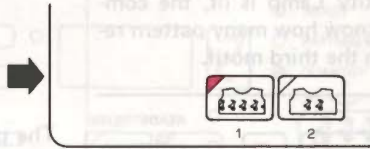

- (3) Push the Step Key.

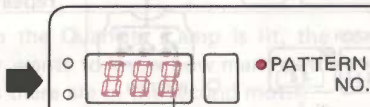

The display shows the memorised pattern number.

## INDICATION OF THE OPERATION PANEL

### • How to correct –

1. Push the CE Key to clear the display. (If you push the Step Key again after pushing the CE Key, the original number that has been memorised will appear in the display again).
2. Enter the correct number.

When you are correcting the pattern number or entering the same pattern number again, the position of the pattern repeat is automatically placed over the centre of the needlebed.

\*When you correct the pattern number with the Selector at (1), the number is also corrected on Selector (2) and the program erased automatically from the computer.

- (4) Push the Step Key.

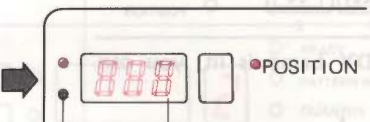

The display shows the position of the left end needle of the centre pattern.

Even if you decide to alter memo information for patterns from "STITCH WORLD", it will appear again in its original form when you correct the pattern number or enter that number again.

### • How to correct –

1. Push the CE Key to clear the display. The Yellow and Green Lamps are flashing on and off. (If you push the Step Key again after pushing the CE Key, the original number that has been memorised will appear in the display again).
2. Push the Yellow or Green Key and enter the correct number for the pattern position.

- (5) Push the Step Key.

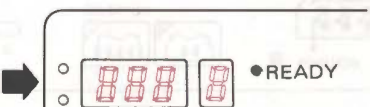

The READY Lamp is lit.

● **How to check the pattern program for Selector (2).**

- (1) Make sure that all Variation Keys are set correctly.
- (2) Choose Selector (2).



- (3) Push the Step Key.

STEP

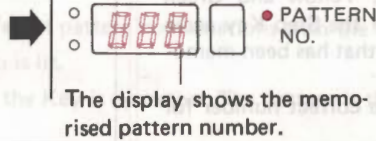

● **How to correct –**

1. Push the CE Key to clear the display. (If you push the Step Key again after pushing the CE Key, the original number that has been memorised will appear in the display again.)
2. Enter the correct number.

- (4) Push the Step Key.

STEP

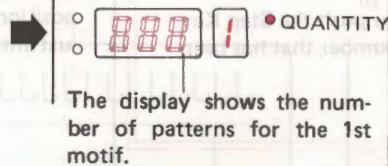

● **How to correct –**

1. Push the CE Key to clear the display. (If you push the Step Key again after pushing the CE Key, the original number that has been memorised will appear in the display again.)
2. Enter the correct number.

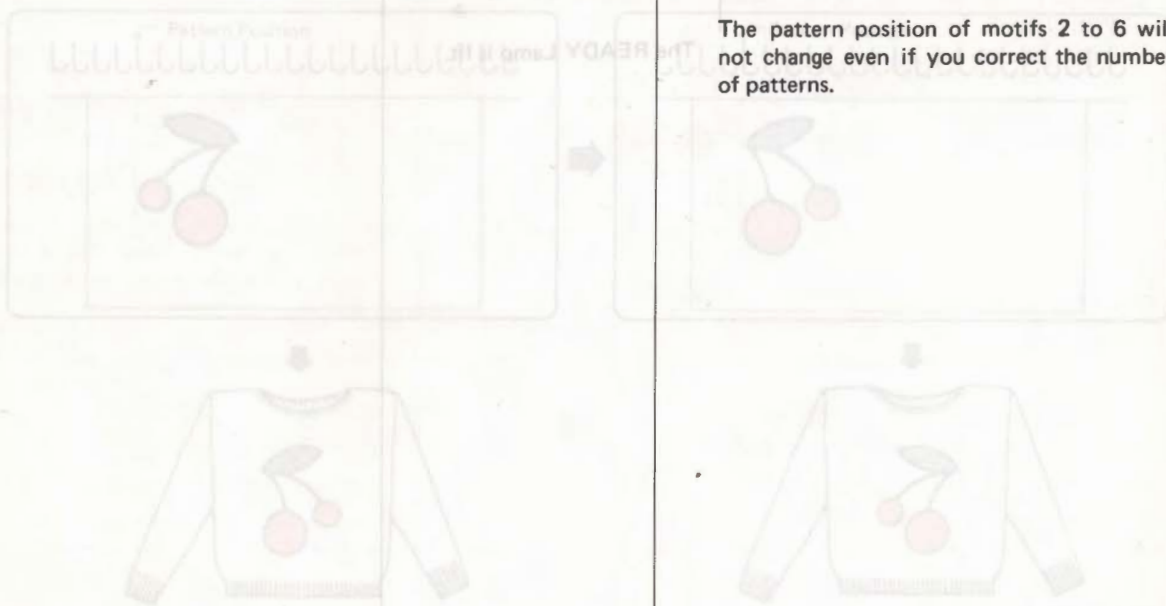

Remember: The pattern direction is different when you view it from the plain side and from the knit side.

**INDICATION OF THE OPERATION PANEL**

When you correct the pattern number or enter the same pattern number again, the program previously entered for Selector (2) is erased from the computer.

\*At the same time, the pattern number is also corrected on Selector (1) and the position of the pattern repeat is automatically placed over the centre of the needlebed.

Even if you decide to alter memo information for patterns from "STITCH WORLD", it will appear again in its original form when you correct the pattern number or enter that number again.

When you are correcting the number of patterns for the 1st motif, the pattern position (first end needle) will automatically place the 1st motif over the centre of the needlebed.

The display will show the new Pattern Position.

The pattern position of motifs 2 to 6 will not change even if you correct the number of patterns.

(5) Push the Step Key.

STEP

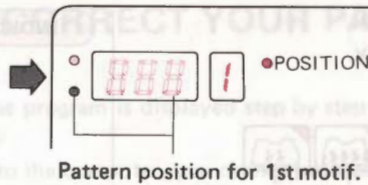

- **How to correct —**  
Push the CE Key to clear the display. The Yellow and Green Lamps are flashing on and off. (If you push the Step Key again after pushing the CE Key, the original number that has been memorised will appear in the display again.)  
Push the Yellow or Green Key and enter the correct number for the pattern position.

★ For the 2nd to 6th motifs, repeat Steps 4 – 5.

(6) Push the Step Key.

STEP

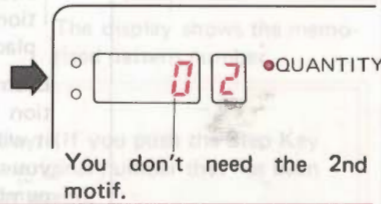

- **How to correct —**  
Push the CE Key to clear the display. (If you push the Step Key again after pushing the CE Key, the original number that has been memorised will appear in the display again).  
Enter the correct number.

Push the Step Key and go on to the pattern position for the motif for which you have just entered the new number of patterns.

(7) Push the Step Key.

STEP

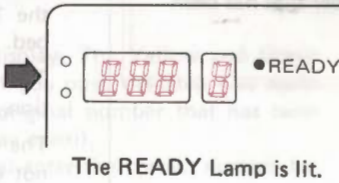

# HOW TO USE THE VARIATION KEYS

2 MIRROR IMAGE KEY

## VARIATION

<b>1</b>	<b>2</b>	<b>3</b>	<b>4</b>	<b>5</b>	<b>6</b>	<b>7</b>
REVERSE	MIRROR IMAGE	DOUBLE WIDTH	DOUBLE LENGTH	UPSIDE DOWN	KHC	KRC

- You can have fun making lots of different pattern combinations with the Variation Keys.
- They are set when the READY Lamp is lit.
- The Variation Lamp will be lit when the Key is operative. The pattern is then varied according to whichever Keys you have pushed.

## 1 REVERSE KEY

1						

The direction of the pattern is changed.

When the Reverse Key is off ...

The pattern made on your knitting (as seen from the purl side) is in the same direction as the diagram in "STITCH WORLD".

When the Reverse Key is on ...

The pattern made on your knitting (as seen from the purl side) is in the opposite direction to the diagram in "STITCH WORLD".

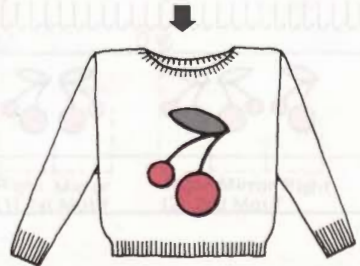
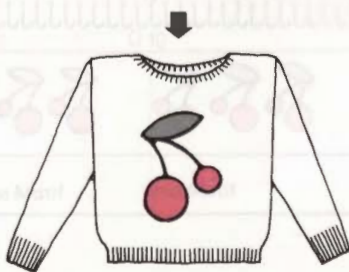
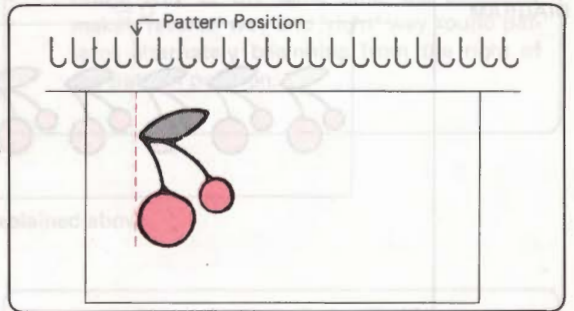
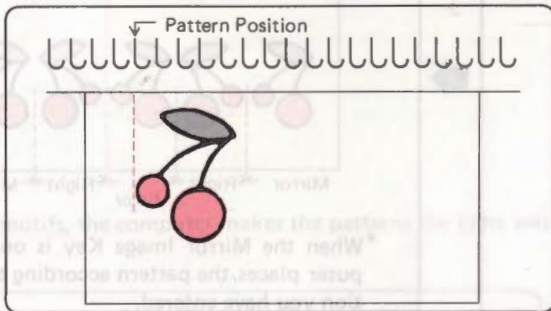
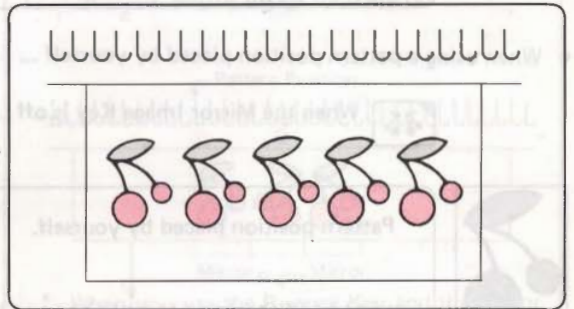
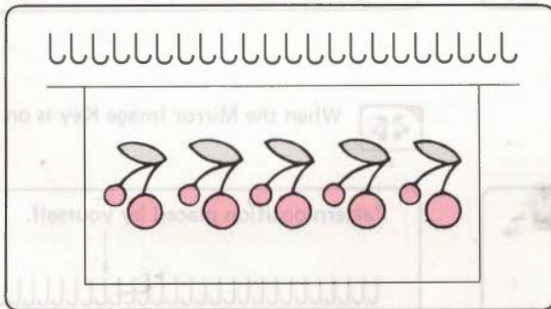

**Remember:** The pattern direction is different when you view it from the plain side and from the purl side.

## 2 MIRROR IMAGE KEY

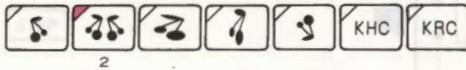

The pattern is knitted with a mirror image.

When the pattern faces in the same direction as the diagram, it is the right way round.  
When the pattern faces in the opposite direction to the diagram, it is the reverse way round.

### Pattern using Selector (1)

- When using the pattern position which is placed automatically by the computer ...

 When the Mirror Image Key is off ...



DIAGRAM

The computer automatically places the pattern over the centre of the needled.

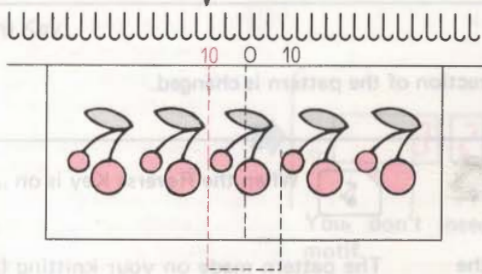

 When the Mirror Image Key is on ...

Pattern position automatically placed by the computer.

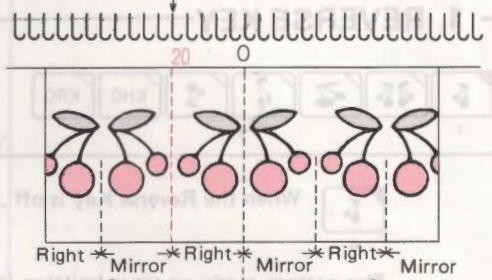

\*When the Mirror Image Key is on, the computer places the foldline of the mirror image pattern at the centre of the needled.

- When using a pattern position placed by yourself ...

 When the Mirror Image Key is off ...



DIAGRAM

Pattern position placed by yourself.

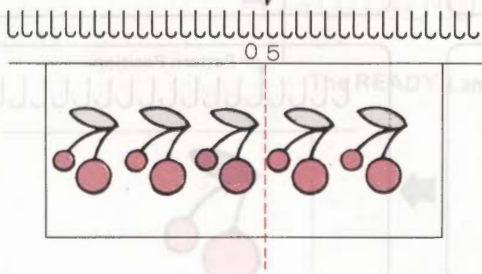

 When the Mirror Image Key is on ...

Pattern position placed by yourself.

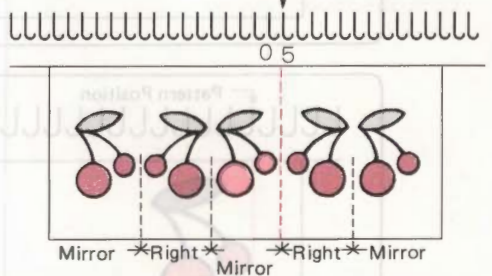

\*When the Mirror Image Key is on, the computer places the pattern according to the position you have entered.

## Pattern using Selector (2)

- When you use the Mirror Image Key, the computer makes patterns alternately the "right" way and "reverse" way round, beginning from the right of the pattern position.



When the Mirror Image Key is off ...

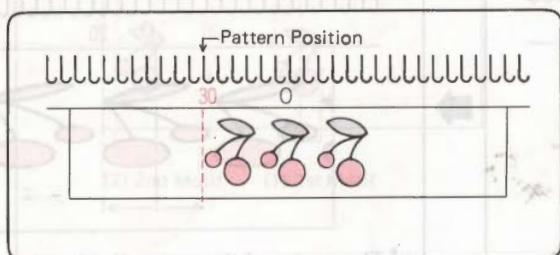
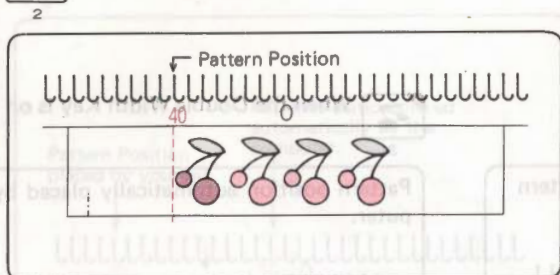

When the Mirror Image Key is on ...

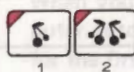
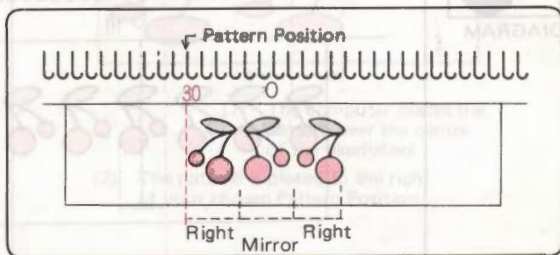
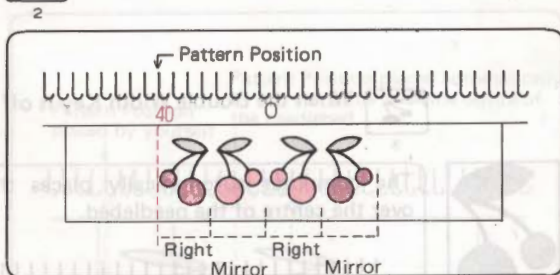

When both the Reverse and the Mirror Image Keys are on ...

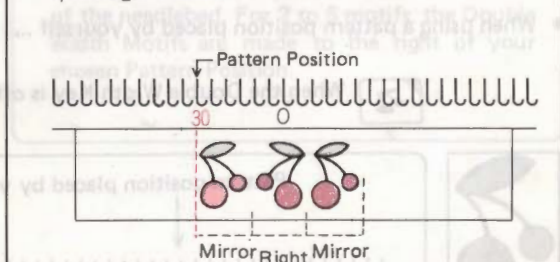

\* When you use the Reverse Key and the Mirror Image Key at the same time, the computer makes 'reverse' way and 'right' way round patterns alternately beginning from the right of the pattern position.

- For 2 to 6 motifs, the computer makes the patterns the same way as explained above.

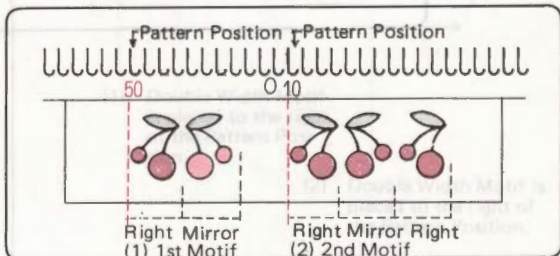
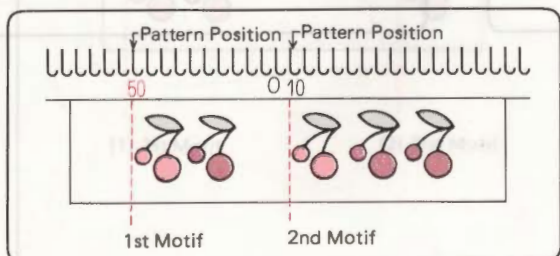

\* When you use the Double Width Key, each Motif is knitted in double width, and it starts from the pattern position chosen by you.



### 3 DOUBLE WIDTH KEY

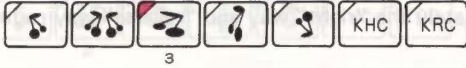



The pattern is knitted in double width.

#### Pattern using Selector (1)

- When using the pattern position which is placed automatically by the computer ...

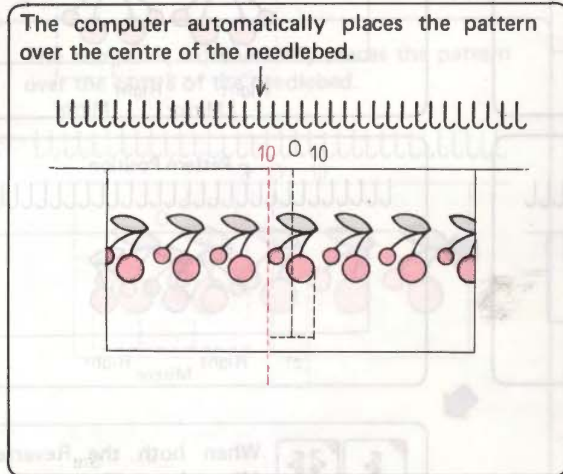
 When the Double Width Key is off ...



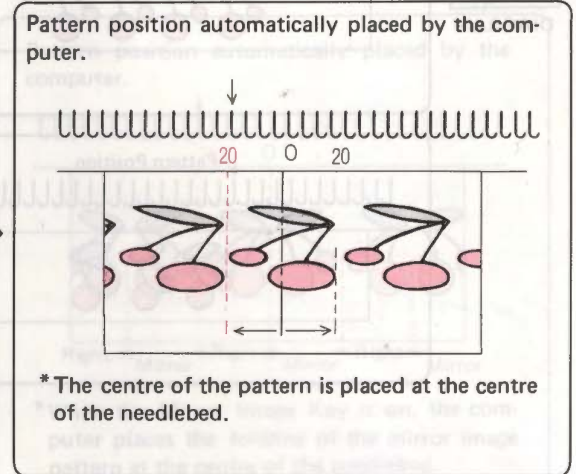

 When the Double Width Key is on ...

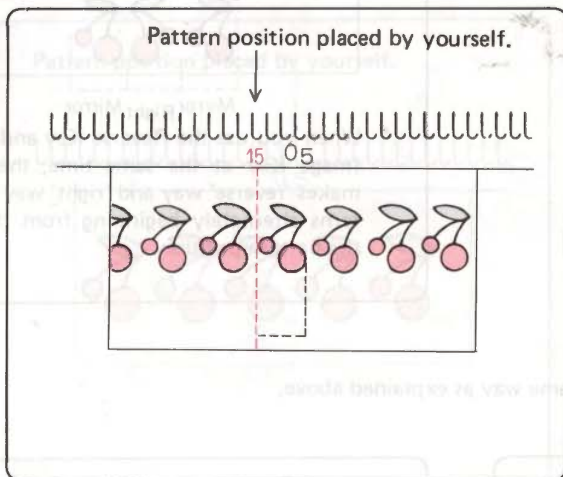

- When using a pattern position placed by yourself ...

 When the Double Width Key is off ...



 When the Double Width Key is on ...

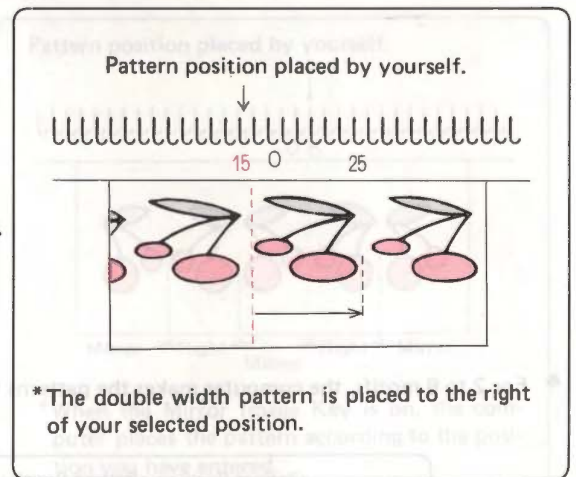

## Pattern using Selector (2)

The example uses 2 motifs.

- When using the pattern position for the first motif which is placed automatically by the computer ...

### When the Double Width Key is off ...



DIAGRAM

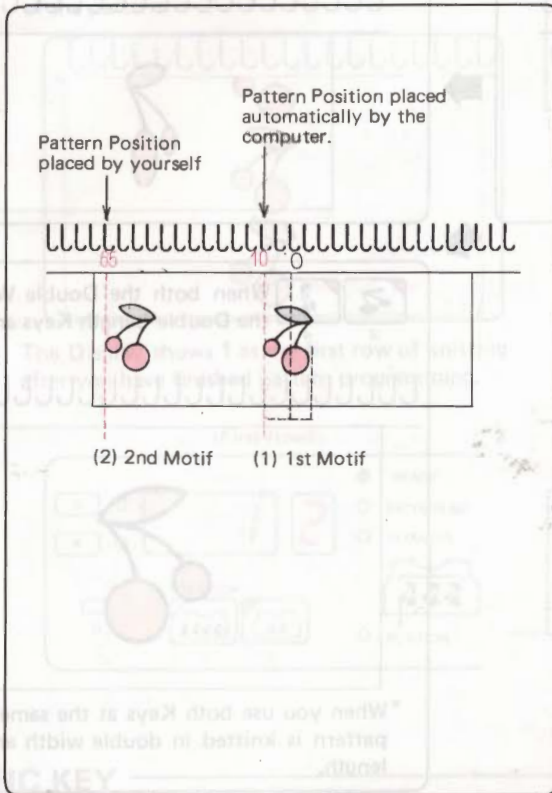

### When the Double Width Key is on ...

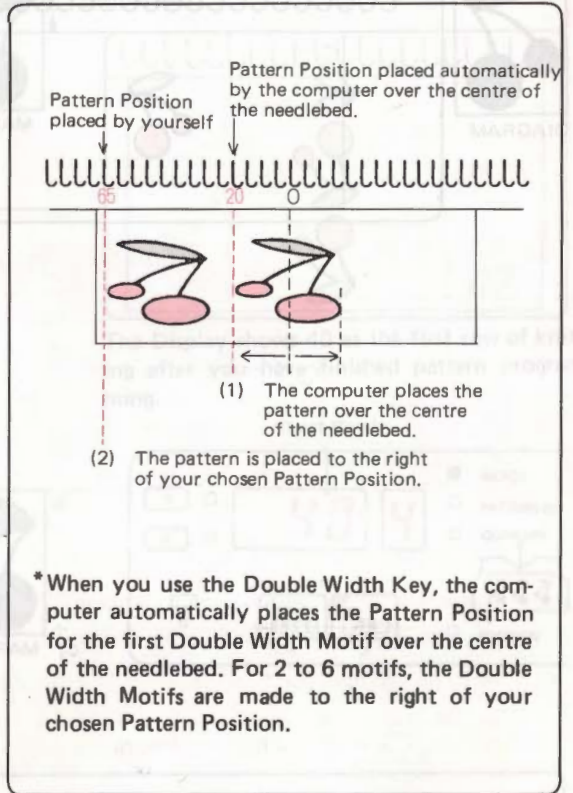

- When using a pattern position placed by yourself ...

### When the Double Width Key is off ...



DIAGRAM

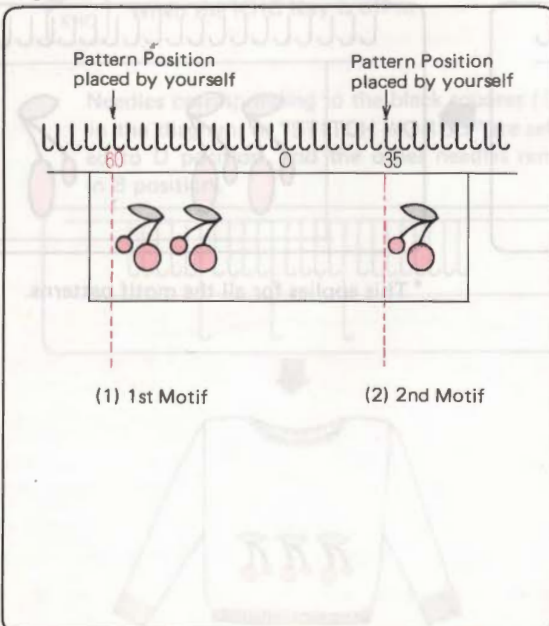

### When the Double Width Key is on ...

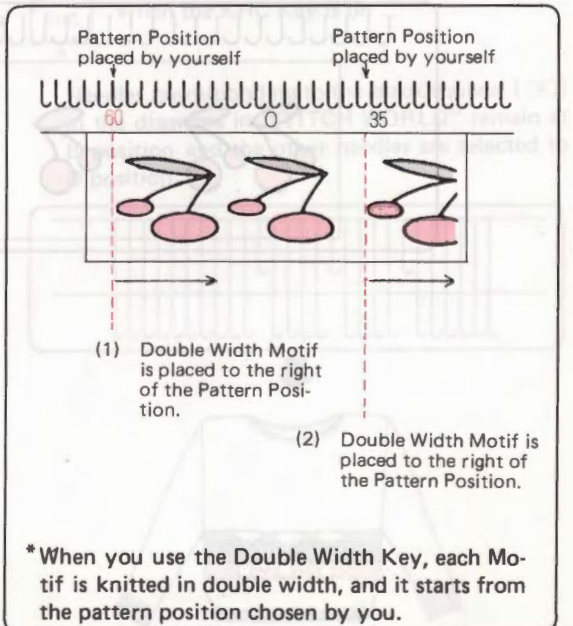

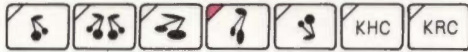

## 4 DOUBLE LENGTH KEY



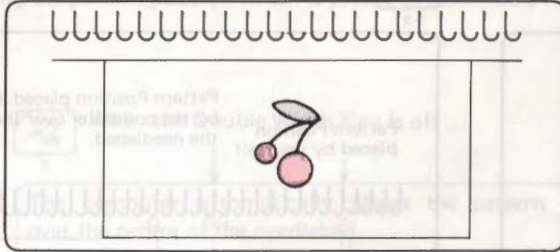

The pattern is knitted in double length.

 When the Double Length Key is off ...

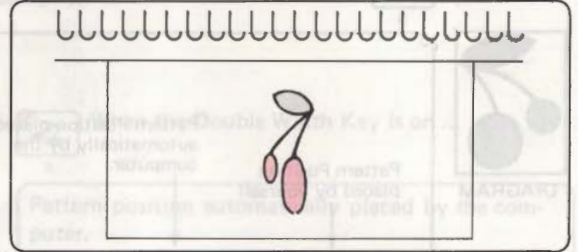

 When the Double Length Key is on ...



  When both the Double Width and the Double Length Keys are on ...

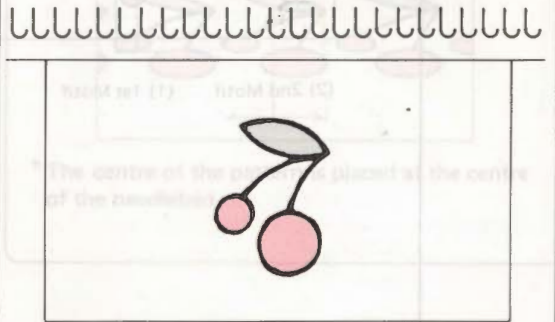

\*When you use both Keys at the same time, the pattern is knitted in double width and double length.

### • Pattern using 2 motifs

 When the Double Length Key is off ...

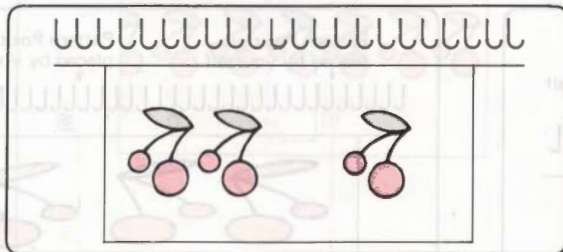

 When the Double Length Key is on ...

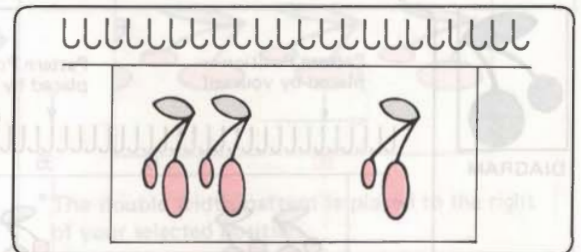

\* This applies for all the motif patterns.

## 5 UPSIDE DOWN KEY

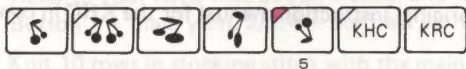

The pattern is knitted upside down.

When the Upside Down Key is off ...



The pattern starts at the first row (bottom row) of the pattern.

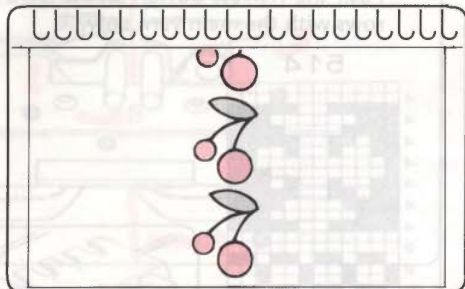

The Display shows 1 as the first row of knitting after you have finished pattern programming.

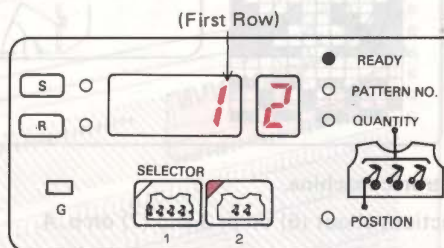

When the Upside Down Key is on ...



The pattern starts at the last row (top row) of the pattern.

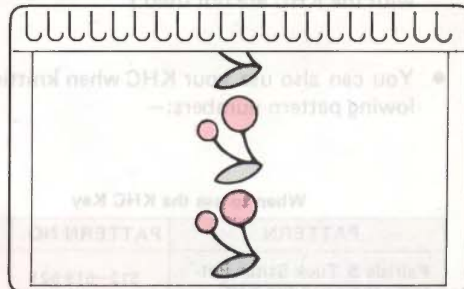

The Display shows 40 as the first row of knitting after you have finished pattern programming.

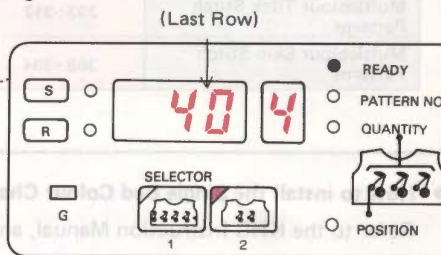

## 6 KHC KEY



The Pattern is knitted in negative.

■ When using the KHC Key without the Single Bed Colour Changer (KHC).

When the KHC Key is off ...

Needles corresponding to the black squares (■) in the diagrams in "STITCH WORLD" are selected to D position, and the other needles remain in B position.

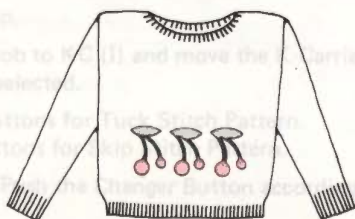
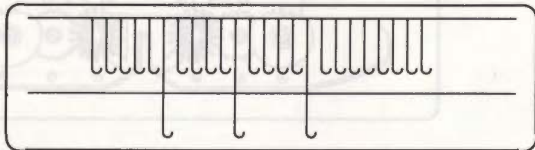

When the KHC Key is on ...

Needles corresponding to the black squares (■) in the diagrams in "STITCH WORLD" remain at B position and the other needles are selected to D position.

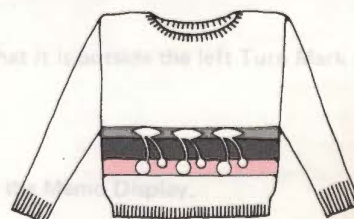
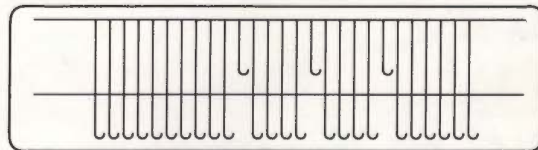

## ■ When you use the Single Bed Colour Changer (KHC)

This can be fitted to both electronic and punchcard machines. Please read the original instruction manual for the KHC in conjunction with the following instructions.

### ● Pattern

- All the patterns shown in the KHC instruction manual are also memorised in the computer, so you should select the pattern you require from "STITCH WORLD". (The punchcards that come with the KHC are not used.)
- You can also use your KHC when knitting the following pattern numbers:—

When to use the KHC Key

PATTERN	PATTERN NO.	KHC
Fairisle & Tuck Stitch Patterns shown in the KHC Manual.	512~519-521 520	ON ON
Multicolour Fairisle Patterns	43~84	ON
Multicolour Tuck Stitch Patterns	293~312	OFF
Multicolour Skip Stitch Patterns	368~394	OFF

- ★ How to knit "STITCH WORLD" Pattern No. 514. When the Display shows knitting row numbers 5, 19, 25 and 39, all the needles are selected to D position.
- ★ Push the Release Button on the KHC and knit two rows with the main yarn only.

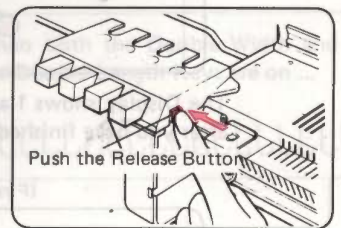
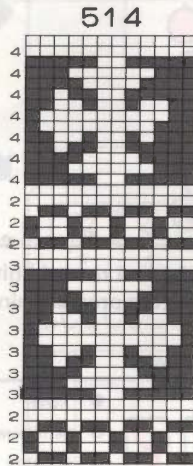

- How to install the Single Bed Colour Changer (KHC) onto the electronic machine.

Refer to the KHC Instruction Manual, and see the following instructions about (6) on p. 3 and (7) on p. 4.

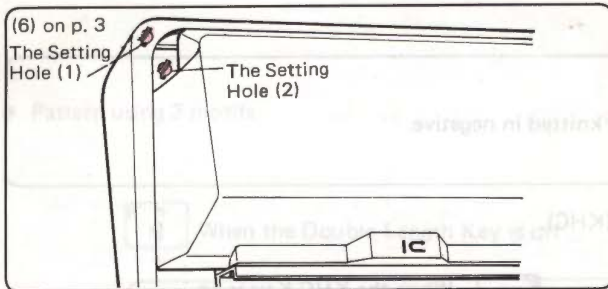

You don't have to set the Yarn Tension Stand. You can use the setting hole on the corner of your knitting machine.

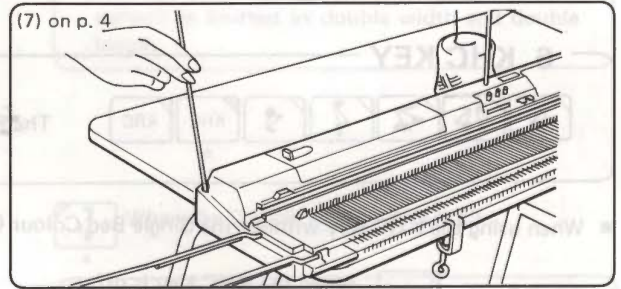

Place the Second Yarn Tension Unit into the setting hole. You can choose either hole (1) or hole (2), but when you use the Knit Leader, select hole (2).

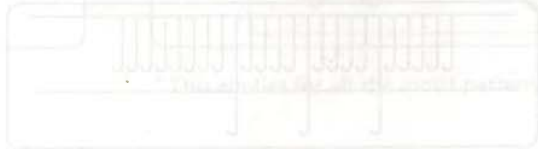

### ■ Fairisle Pattern

- (1) Refer to your KHC Instruction Manual and thread up main and contrast yarns.  
Button 1 – main yarn, 2/3/4 – contrast yarns.
- (2) Knit 10 rows in stocking stitch with the main yarn and place the K-Carriage on the righthand side of the machine.
- (3) Program the pattern.
- (4) Transfer the main yarn from Yarn Feeder "A" into Yarn Feeder "B".

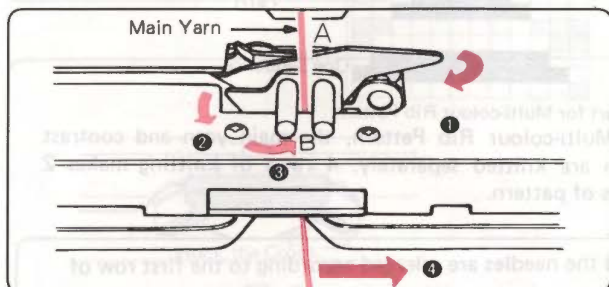

- (5) Take the main yarn off Roller 1 and cancel Changer Button 1.
- (6) Bring all needles forward from B to E position.

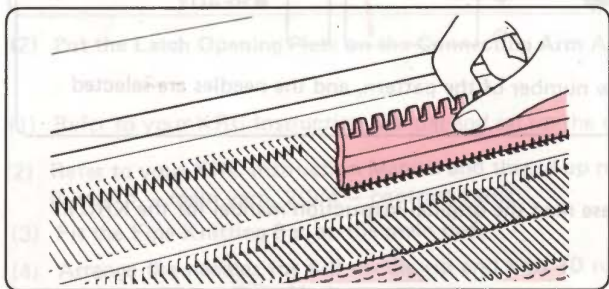

- (7) Move the K-Carriage to outside the right Turn Mark.  
Set the Change Knob to KC (I) or KC (II) and push the MC Button.
- (8) Move the K-Carriage across the needlebed from right to left, so that it is outside the left Turn Mark and the needles have been selected.
- (9) Continue knitting. Push the Changer Button according to the number shown in the Memo Display.

### ■ Multi-colour Tuck and Multi-colour Skip Stitch Patterns.

- (1) When you knit Multi-colour Tuck Stitch Patterns with the KHC, put the Weaving Brushes in action. (Put them out of action when you knit the other patterns).

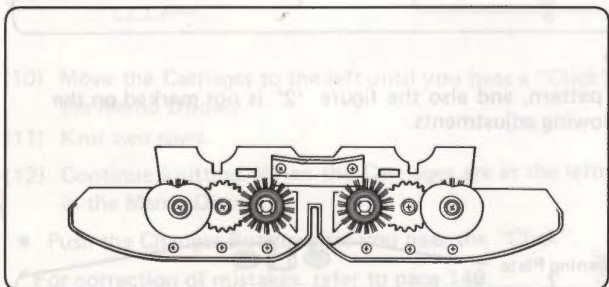

- (2) Thread the yarn into the KHC and knit approx. 10 rows ending with the K-Carriage at the right. Place the K-Carriage outside the right Turn Mark.
- (3) Program the pattern.
- (4) Set the Change Knob to KC (I) and move the K-Carriage from right to left so that it is outside the left Turn Mark and the needles have been selected.
- (5) Push both Tuck Buttons for Tuck Stitch Pattern.  
Push both Part Buttons for Skip Stitch Pattern.
- (6) Continue knitting. Push the Changer Button according to the number shown in the Memo Display.

## 7 KRC KEY

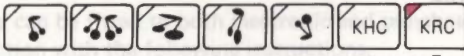

Multi-colour Rib Pattern is worked using both the ribber and the Double Bed Colour Changer (KRC).

**KRC** When the KRC Key is off ...



Chart for single bed Fairisle Pattern

**KRC** When the KRC Key is on ...

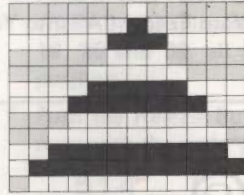

■ C-Knitted with Contrast Yarn  
 □ M-Knitted with Main Yarn

One Sequence

Chart for Multi-colour Rib Pattern

In Multi-colour Rib Pattern, the main yarn and contrast yarn are knitted separately. 4 rows of knitting makes 2 rows of pattern.

- When you put the KRC Key on or off, the Display shows 1 and the needles are selected according to the first row of knitting.

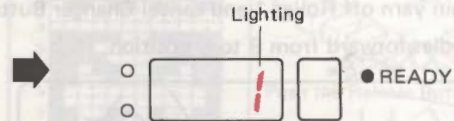
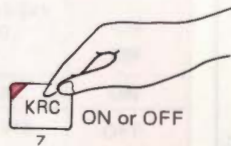

\*When the Upside Down Key is on, the Display shows the last row number of the pattern, and the needles are selected according to the last row.

- When you use the Double Bed Colour Changer (KRC)

This can be fitted to both electronic and punchcard machines. Please read the original instruction manual for the KRC in conjunction with the following instructions.

### • Pattern

- All the patterns shown in the KRC instruction manual are also memorised in the computer, so you should select the pattern you require from "STITCH WORLD". (The punchcards that come with the KRC are not used.)
- You can knit Multi-colour rib pattern using the pattern number of Fairisle, Multi-colour Fairisle, and Single Motif patterns built in the computer with KRC Key on.

### • Pattern Program

- Push the KRC Key and check the lamp is lit.
- You can use another Variation Key at the same time as the KRC Key if you wish.
- You can use the KRC Key to make single Motifs in conjunction with Selector (2). (Please disregard the instruction on page 17 of the KRC Instruction Manual).

### • ADJUSTMENTS TO RIBBER CONNECTING ARM ASSEMBLY

Should your Ribber be one with which you can knit plated stitch pattern, and also the figure '2' is not marked on the underside of the connecting arm assembly, you should make the following adjustments.

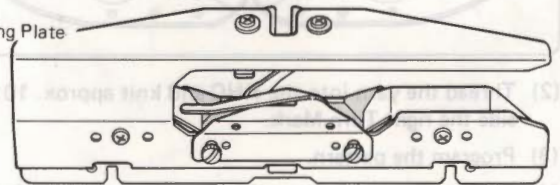
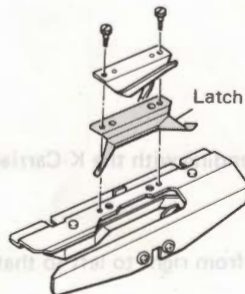
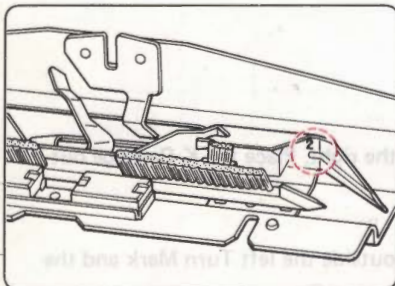

After Setting Up

If you want to knit multi-colour rib pattern, connect the Latch Opening Plate to the connecting arm assembly.

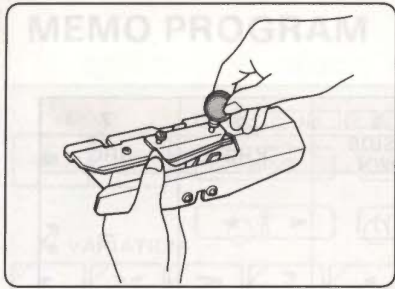

(1) Remove the screw to take out the Yarn Feeder.

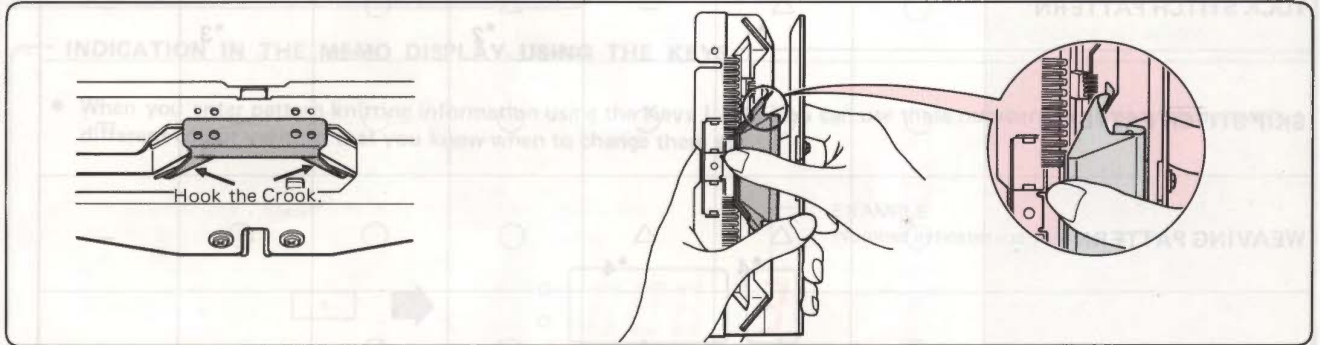

(2) Put the Latch Opening Plate on the Connecting Arm Assembly, and then screw up the Yarn Feeder.

- (1) Refer to your KRC Instruction Manual and set up the ribber and KRC onto your machine.
- (2) Refer to your KRC Instruction Manual and thread up main and contrast yarns.  
Button 1 – main yarn, 2/3/4 – contrast yarns.
- (3) Fit the Fine Knitting Bar on the main bed.
- (4) Arrange the needles for full needle rib and knit 10 rows with the main yarn in full needle rib. Place the K-Carriage outside the lefthand Turn Mark.
- (5) Choose the pattern.
- (6) Program the pattern.
- (7) Set the Change Knob to KC (II).
- (8) Move the K-Carriage across the needlebed from left to right using the main yarn, so that the needles have been selected.
- (9) Set the K-Carriage and the KR Carriage as shown in the illustration.

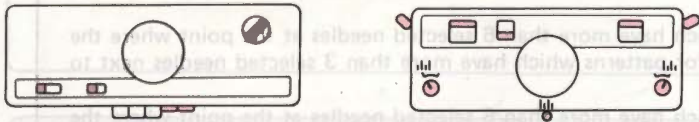

- (10) Move the Carriages to the left until you hear a "Click". Now push the Changer Button according to the number shown in the Memo Display.
- (11) Knit two rows.
- (12) Continue knitting. When the Carriages are at the lefthand side, push the Changer Button according to the number shown in the Memo Display.

- Push the Changer Button after you hear the "Click".
- \* For correction of mistakes, refer to page 149.

*\* If having problems check  
your bottom bed needles + red needle white needles*



## LIST OF VARIATION KEYS

Use the appropriate Variation Key to knit the patterns marked "O" in the columns below.

	1 REVERSE	2 MIRROR IMAGE	3 DOUBLE WIDTH	4 DOUBLE LENGTH	5 UPSIDE DOWN	6 KHC	7 KRC
FAIRISLE PATTERN	○	○	○	○	○	○	—
TUCK STITCH PATTERN	○	△ *1	—	△ *2	○	— *3	—
SKIP STITCH PATTERN	○	○	○	○	○	— *3	—
WEAVING PATTERN	○	△ *4	△ *4	○	○	○	—
THREAD LACE PATTERN	○	△ *5	△ *5	○	○	—	—
PLATED TUCK STITCH PATTERN	○	△ *1	—	—	○	— *3	—
LACE/FINE LACE PATTERN	—	—	—	—	—	—	—
MULTI-COLOUR RIB	○	○	○	○	○	○	○ *6

\*1 — Don't use the Mirror Image Key for a pattern which has more than 2 tuck stitches at the point where the patterns join. (See p. 62 Tuck Stitch Patterns.)

\*2 — Use the Double Length Key according to the remarks on page 62 under Tuck Stitch Patterns.

\*3 — You can knit Tuck Stitch, Plated Tuck Stitch and Skip Stitch Patterns from "STITCH WORLD" without using the KHC Key.

\*4 — Don't use the Mirror Image Key for patterns which have more than 6 selected needles at the point where the patterns join. Don't use the Double Width Key for patterns which have more than 3 selected needles next to each other. (See p. 62 under Weaving Pattern.)

\*5 — Don't use the Mirror Image Key for patterns which have more than 6 selected needles at the point where the patterns join. Don't use the Double Width Key for patterns which have been more than 3 selected needles next to each other. (See p. 62 under Thread Lace Pattern.)

\*6 — Always the KRC Key when you knit multi-colour Rib.

# MEMO PROGRAM

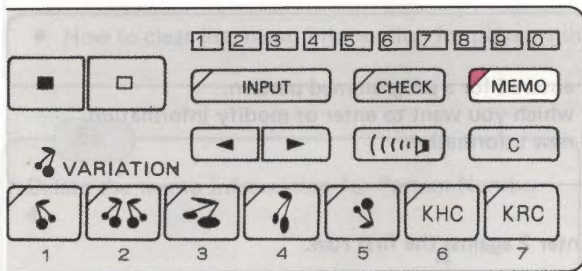

You can program the Memo with information for pattern knitting, and this will be shown in the Memo Display whilst you knit.

- you can also easily enter, delete and modify the Memo information.
- Use the Keys 1 – 9 and the Yellow and Green Keys to enter this information.

## INDICATION IN THE MEMO DISPLAY USING THE KEYS

- When you enter pattern knitting information using the Keys 1 – 9. You can use these numbers to distinguish between different colour yarns so that you know when to change them etc.

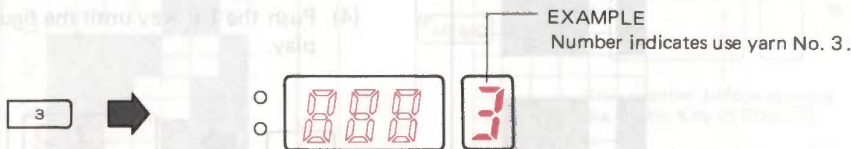

- When you enter pattern knitting information using the Yellow or the Green Key. You can use these to show which Lace Change Lever setting to use, etc.

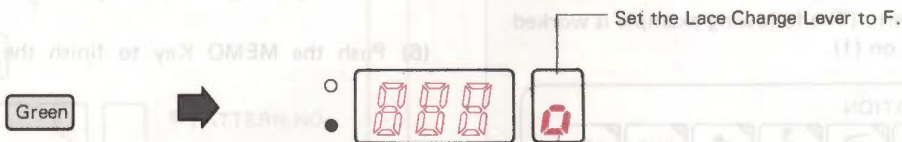
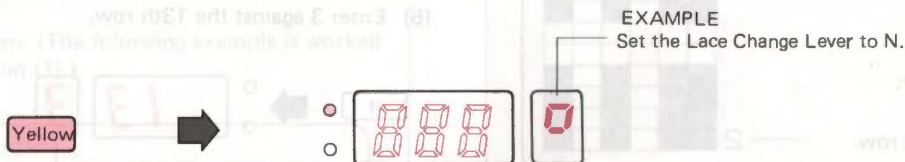

- Memo details for the patterns in "STITCH WORLD" that you have modified or deleted will revert back to their original form in the following cases:—

- (1) When you enter the Pattern Number
  - The same number is entered again.
  - A different pattern number is entered.
- (2) When you program the Input Program.

While you are programming, if you should push any of the Keys 1-9, the Yellow or the Green Key by mistake, or you want to correct the memorized information, push the CE Key to clear the Memo Display, and enter the correct figure.

## ■ HOW TO PROGRAM THE "MEMO PROGRAM".

# MEMO PROGRAM

### (1) ENTERING THE MEMO INFORMATION

- You can enter extra information or modify the information already entered for a programmed pattern.
- Advance the row number in the Display until you reach the row for which you want to enter or modify information. Do this by pushing either the UP or DOWN Key, and then enter the new information.

Ex.

Memo program for Pattern No. 2.

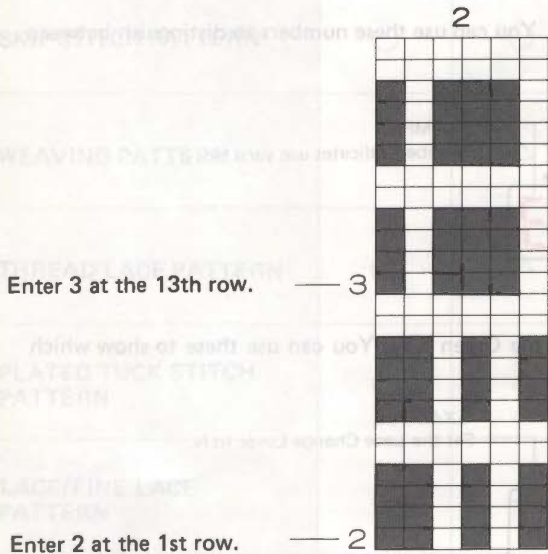

- (1) Program the pattern. (The following example is worked with the Selector on (1).)

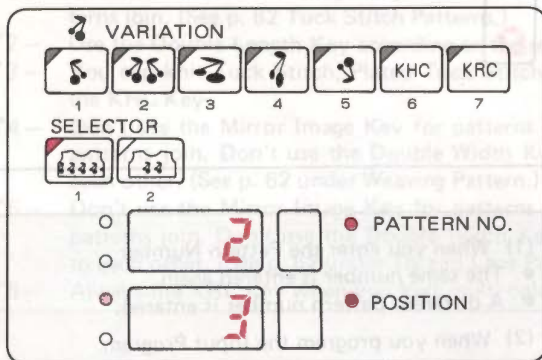

- (2) When the READY Lamp is lit, push the MEMO Key. (The READY Lamp goes off.)

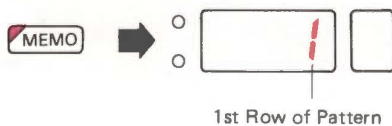

- (3) Enter 2 against the first row.

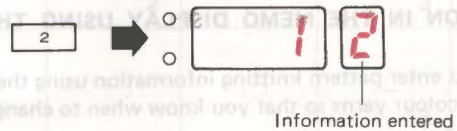

- (4) Push the UP Key until the figure 13 appears in the Display.

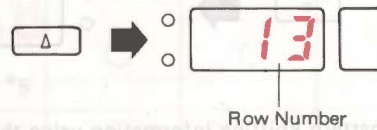

- (5) Enter 3 against the 13th row.

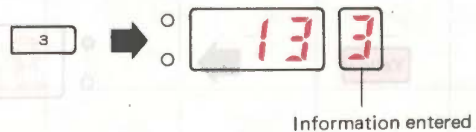

- (6) Push the MEMO Key to finish the Memo Program.

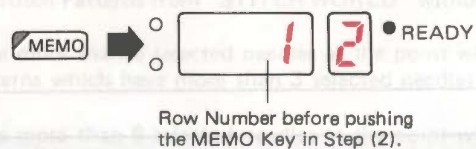

- \* The READY Lamp is lit and you have now completed the Memo Program.
- \* The Display shows the first row of your pattern, and the information you have entered (2) appears in the Memo Display.

- While you are programming:  
If you should push any of the Keys, 1-9, the Yellow or the Green Key by mistake, or you want to correct the memorized information, push the CE Key to clear the Memo Display, and enter the correct figure.

## (2) DELETING THE MEMO INFORMATION

- How to clear the memo information for patterns that have been memorised.

Ex.

Delete the memo information for Pattern Number 4.

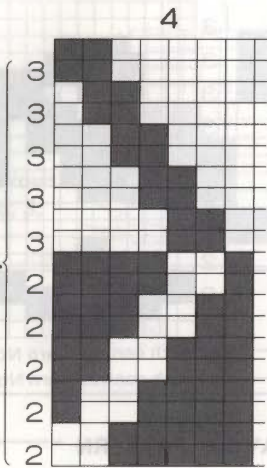

Delete all the information.

- (1) Program the pattern. (The following example is worked with the Selector on (1).)

**VARIATION**

1 2 3 4 5 6 7

**SELECTOR**

1 2

○  **PATTERN NO**

●  **POSITION**

- (2) When the READY Lamp is lit, push the MEMO Key. (The READY Lamp goes off.)

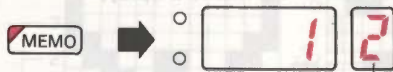

Memorised information for the first row.

- (3) Push the C Key. (Memo information is deleted from the computer.)



Display is cleared.

- (4) Push the Memo Key to finish deleting the Memo information.



Row number before pushing the Memo Key in Step (2).

- \* The READY Lamp is lit and the program is completed.

# MEMO INFORMATION IN THE PATTERNS IN "STITCH WORLD"

- Please refer to the Diagrams on the back pages of your "STITCH WORLD" PATTERN BOOK.
- The Memo Information is shown on the left side of the Diagrams and it also appears in the Memo Display.

Memo Information

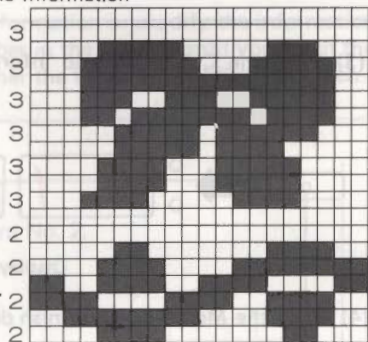

- When knitting the 3rd row of the pattern.

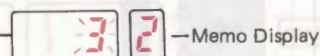

- The meaning of the Memo Information will be different depending on the type of pattern you are knitting.

## TUCK & SKIP STITCH PATTERN

- The Memo information is used to distinguish between different colour yarns in multi-colour pattern knitting.

306

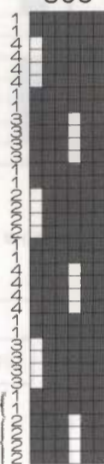

- Knit with yarn No. 1
- Knit with yarn No. 2

## FAIRISLE PATTERN

- The Memo information is used to distinguish between the contrast yarns.
- No. 1 is used for the main yarn and the other numbers for the contrast yarns.

55

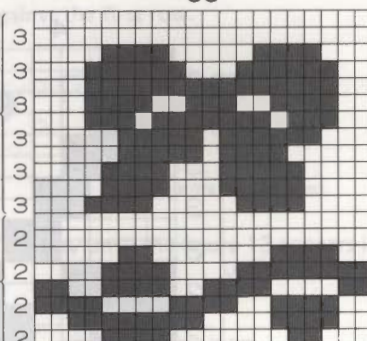

- Knit with contrast yarn No. 2.
- Knit with contrast yarn No. 3.

## WEAVING PATTERN

- The Memo information is used to distinguish between the weaving yarns.
- When no number is shown in the Memo Display, you should knit this row without a weaving yarn.

453

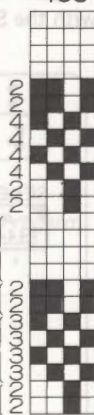

- Knit without a weaving yarn.
- Knit with weaving yarn No. 2.
- Knit with weaving yarn No. 3.
- Knit with weaving yarn No. 2.

## LACE & FINE LACE PATTERN

- If no number is shown in the Memo Display, operate the L-Carriage.
- When a number appears in the Memo Display, knit as many rows with the K-Carriage as the number indicates.

164

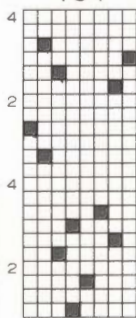

- Knit 4 rows with the K-Carriage.
- Operate the L-Carriage.
- Knit 2 rows with the K-Carriage.
- Operate the L-Carriage.

## LACE & FINE LACE PATTERNS MIXED

- Use the L-Carriage and the K-Carriage as indicated by the symbol or number in the Memo Display.

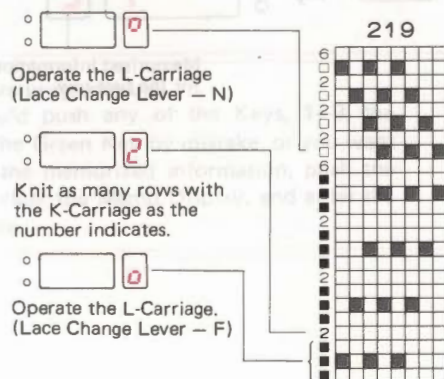

- Operate the L-Carriage (Lace Change Lever - N)
- Knit as many rows with the K-Carriage as the number indicates.
- Operate the L-Carriage (Lace Change Lever - F)

## MULTI-COLOUR RIB

- For Fairisle Pattern the Memo information is used as follows:—
- Memo information on odd numbered rows — distinguishes between different coloured contrast yarns.
- Memo information on even numbered rows — distinguishes between different coloured main yarns.

Knit the first and 2nd rows with Main yarn No. 2.

Knit the first and 2nd rows with Contrast yarn No. 3.

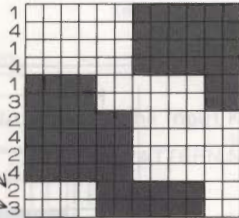

- (1) When there is no Memo information on the Diagram:—
  - Knit with only one main yarn and one contrast yarn.
  - The number 1 in the Memo Display tells you to knit with the main yarn, and the number 2 tells you to knit with the contrast yarn.

The Diagram arranged for Multi-colour Rib by the computer.

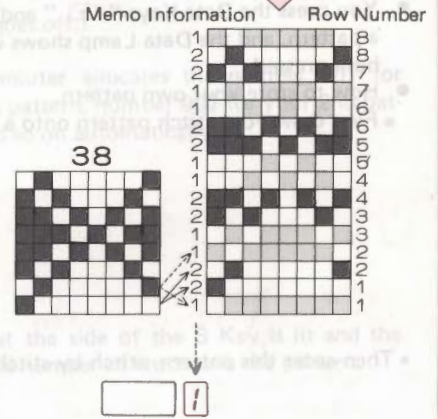

- (2) When the Memo information is on the odd row only:—

- Knit with only one main yarn but several contrast yarns.
- The number 1 in the Memo Display tells you to knit with the main yarn, and the other numbers distinguish between the contrast yarns.

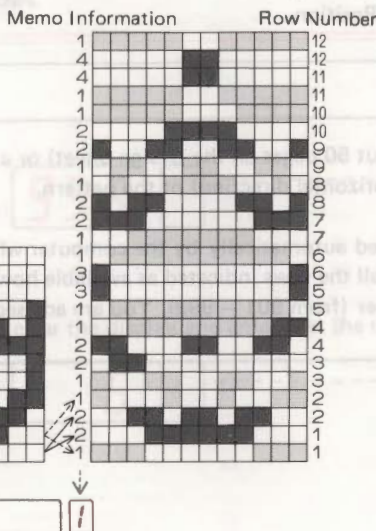

- (3) When the Memo information is on both the odd numbered rows and even numbered rows:—

- Knit with several main yarns and several contrast yarns.
- The numbers in the Memo Display indicate which yarns to use.

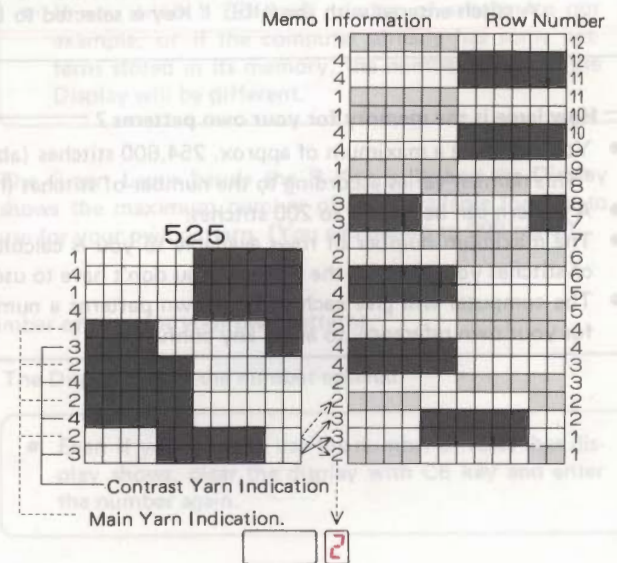

\* If the pattern has large area, it takes 3-4 seconds until the Display changes for next step.

# HOW TO PROGRAM YOUR OWN PATTERNS

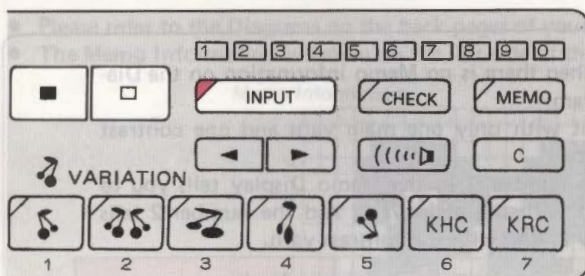

- You can enter and store your own stitch patterns in the computer by using the Input Program.
- This facility allows you to both enter and delete patterns of your own design.

## Data Keys and Data Lamps

- You press the Data Keys "  " and "  " to enter a pattern, and the Data Lamp shows which Keys you have pressed.
- How to store your own pattern.
- First draw your stitch pattern onto a Design Sheet.

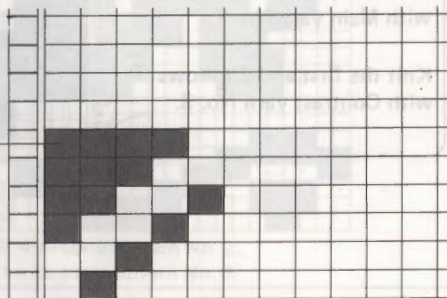

- Then enter this pattern, stitch by stitch, using the Data Keys.
- The Data Lamp shows what pattern data has been entered.

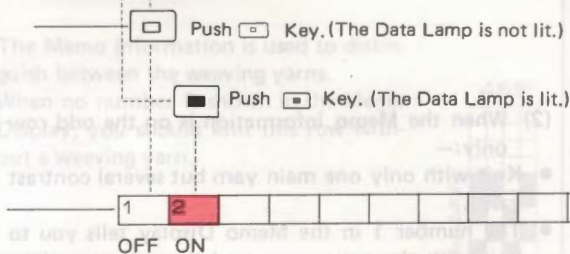



• What is the difference between the Data Keys?  
 A stitch entered with the "  " Key is selected to D Position.  
 A stitch entered with the "  " Key is selected to B Position.

## How large is the memory for your own patterns ?

- You can store a maximum of approx. 254,600 stitches (about 50 pages on the Design Sheet) or a maximum of 98 patterns.  
 \*This number varies according to the number of stitches (horizontal direction) of the pattern.
- A pattern can be from 1 to 200 stitches.
- The maximum number of rows available to you is calculated automatically by the computer when you enter the number of stitches you want for the pattern. You don't have to use all the rows indicated as available however.
- The computer will give each of your own patterns a number (from 901 – 999). You are advised to use this same number for your own reference, to avoid any confusion.

# HOW TO PROGRAM (INPUT PROGRAM)

## ① STORING YOUR OWN PATTERN

- You store your own patterns with the "  " and "  " Keys.

Ex. Enter the following pattern.

DESIGN SHEET

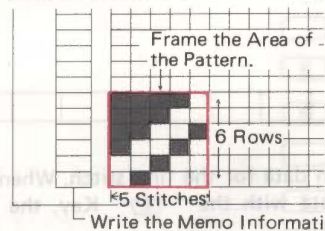

- Before starting to enter your own patterns, you must prepare the following:—

- Draw your own design onto one of the blank Design Sheets which come with the machine.
- Draw a frame around your design.
- Count the number of stitches and the number of rows which make up the pattern.

- Make sure the READY Lamp is lit and push the Input Key. (The READY Lamp goes off.)



- The computer allocates the number 901 for your 1st pattern, number 902 for your 2nd pattern, and so on automatically.

Your own pattern is given a number by the computer. (Use this number yourself as a reference on your Design Sheet to avoid confusion.)

- Enter the number of stitches.

- Push the Step Key.

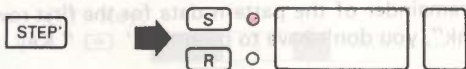

The Yellow Lamp at the side of the S Key is lit and the computer asks for the number of stitches in the pattern.

- Enter 5 as the number of stitches.

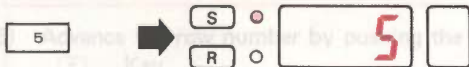

The Display shows the number you have entered.

\* If you should make a mistake, push the CE Key to clear the display, and enter the correct number.

- Enter the number of rows.

- Push the Step Key.

- If you enter a different number of stitches to our example, or if the computer already has some patterns stored in its memory, the number shown in the Display will be different.

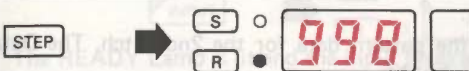

The Green Lamp beside the R Key is lit, and the Display shows the maximum number of rows available for you to use for your own pattern. (You can use up to 998 rows.)

- Push the CE Key to clear the display and enter 6 as the number of rows for your own patterns.

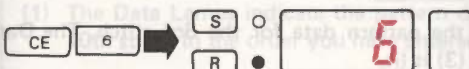

The Display shows the number entered.



- Even if you want to use the number of rows that display shows, clear the display with CE key and enter the number again.

- Push the Step Key.



\* If the pattern has large area, it takes 3—4 seconds until the Display changes for next step.



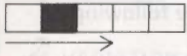

(5) Enter your own pattern data by pushing the "  " Key or the "  " Key according to your drawing on the Design Sheet.

1) Enter the pattern data for the first row.  
If you make a mistake, refer to page 65.

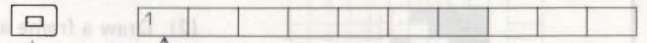

The Green Lamp beside the R Key is lit and the Display shows the row number. (The first stitch of the first row is shown.)



Enter the pattern data for the first stitch. When you enter pattern data with the "  " Key, the Data Lamp is not lit.

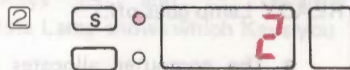

The Yellow Lamp beside the S Key is lit and the Display shows the stitch number. (The 2nd stitch is shown.)

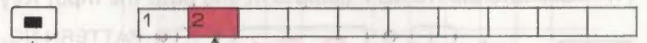

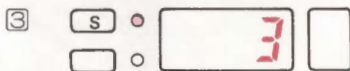

Enter the pattern data for the 2nd stitch. The Data Lamp (2) is lit.

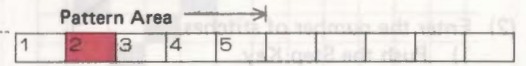

The 3rd stitch is shown.



If the remainder of the pattern data for the first row is "blank", you don't have to push the "  " Key.

• If you prefer you can also push the "  " Key to enter pattern data for every stitch.

2) Enter the pattern data for the 2nd row.

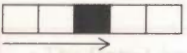

① Push the UP Key to advance the row number.

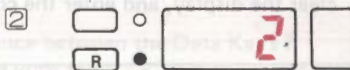

The first stitch of the 2nd row is shown.

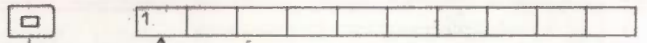

Enter the pattern data for the first stitch. When you enter pattern data with the "  " Key, the Data Lamp is not lit.

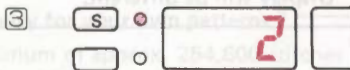

The 2nd stitch is shown.

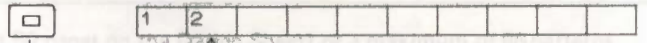

Enter the pattern data for the 2nd stitch. The Data Lamp is not lit.

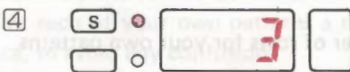

The 3rd stitch is shown.

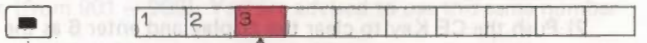

Enter the pattern data for the 3rd stitch. The Data Lamp (3) is lit.

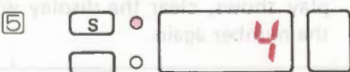

The 4th stitch is shown.

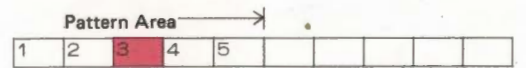

If the remainder of the pattern data for the 2nd row is "blank", you don't have to push the "  " Key.

3) Enter the pattern data for the 3rd Row.

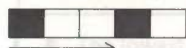

1 Push the UP Key to advance the row number.

2 Follow the indication on the Display and enter the pattern data for the 3rd row with the  and  Keys in the same way as you did for the first and 2nd rows, according to your drawing.

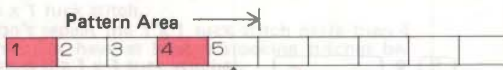
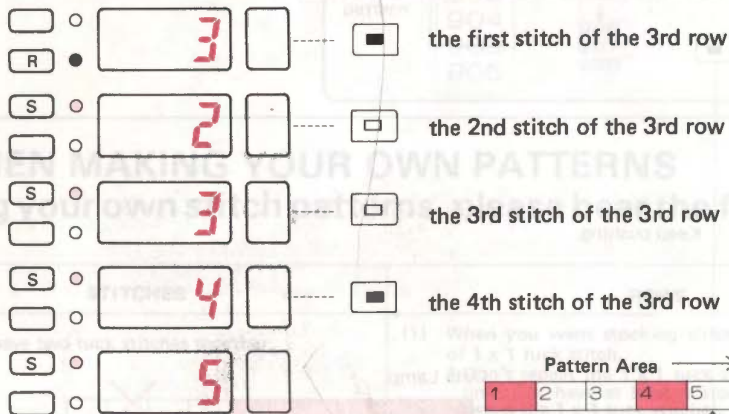

If the remainder of the pattern data for the 3rd row is "blank", you don't have to push the  Key.

4) Advance the row number by pushing the UP Key and enter the pattern data for the 4th row with the  Key and the  Key.

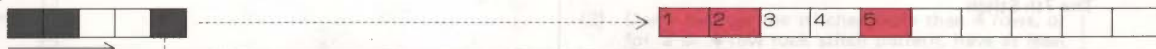

When you enter the pattern data for the 5th stitch, the buzzer makes a sound which tells you that you have reached the end of the program row.

5) Advance the row number by pushing the UP Key and enter the pattern data for the 5th row with the  Key and the  Key.



6) Advance the row number by pushing the UP Key and enter the pattern data for the 6th row with the  Key and the  Key.

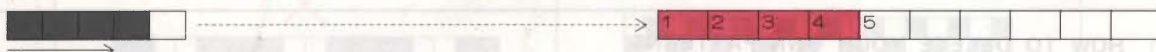

7) After you have finished entering the pattern data, push the Input Key. (The Input Lamp goes out).

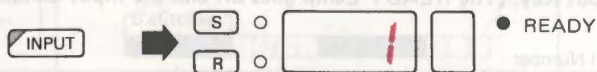

\*The READY Lamp is lit and the input program is completed.

When you want to knit from one of your own patterns, use the pattern number which it was allocated by the computer. Enter this when the Pattern Number Lamp is lit during pattern programming.

■ What to do when your pattern has more than 10 stitches in one row.

Example: Pattern with 14 Stitches

(1) The Data Lamps indicate the pattern data from the first to the 10th stitch in the order you have entered them.

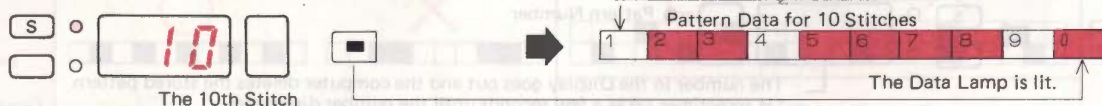

(2) When you enter pattern data for the 11th stitch, all the pattern data lamps for the first 10 stitches go off, and the first Data Lamp now indicates the pattern data for the 11th stitch.

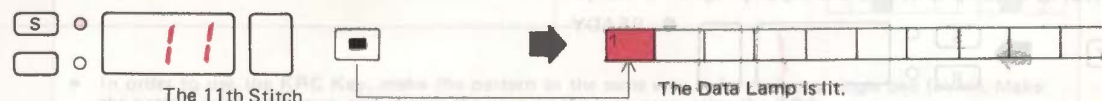

(3) The 2nd Data Lamp indicates the pattern data for the 12th stitch, and so on.

● **How to enter the same pattern data continuously.**

You can enter the same pattern data by pushing the Data Key continuously.

KEY     KEY

The first Stitch of the first row:  R ●

The 2nd Stitch:  S ●

The 3rd Stitch:  S ●

⋮

The 6th Stitch:  S ●

The 7th Stitch:  S ●

Keep pushing. → Release the Data Key. → Next stitch number you can input.

Data Lamp: 1 2 3 4 5 6

● **What to do when the pattern data for the rest of the stitches is "blank".**

You don't have to enter data by pushing the "  " Key stitch by stitch. The pattern data for the rest of the row is entered automatically as "  " by the computer when you push the "  " Key and go on to the next row.

"Blank"

② **HOW TO DELETE YOUR OWN PATTERNS**

- Enter the pattern number that you want to delete and push the C Key.
- (1) Make sure that the READY Lamp is lit. Push the Input Key. (The READY Lamp goes off and the Input Lamp is lit.)

INPUT     S ○   ● Pattern Number

R ○

The pattern number in the Display depends on the number of stored patterns.

- (2) Push the CE Key to clear the Display and enter the number for the pattern that you want to delete.

CE  9  0  5     S ○   ● Pattern Number

R ○

Example: 905 is the pattern number to be deleted.

- (3) Push the C Key.

C     S ○   ● Pattern Number

R ○

The number in the Display goes out and the computer deletes the stored pattern. \*It sometimes takes a few seconds until the number disappears.

- \* If you want to delete more than one stored pattern, repeat Steps (2) – (3).
- (4) Push the Input Key after you have finished deleting stored patterns. (The Input Lamp goes out.)
- \* The READY Lamp is lit and the Input program is completed.

INPUT     S ○   ● READY

R ○

The Display and the Memo Display show the pattern program as it was before you started the Input Program.

The order in which the pattern numbers appear in the Input Program.

- The lowest vacant pattern number appears in the Display.

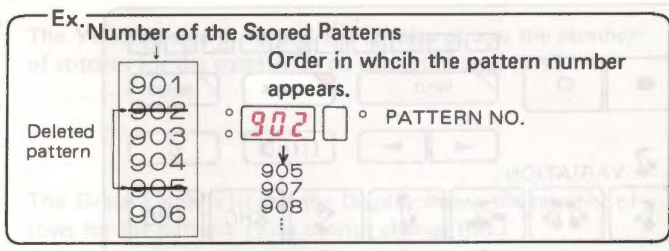

## GUIDELINES WHEN MAKING YOUR OWN PATTERNS

- When designing your own stitch patterns, please bear the following points in mind.

	STITCHES	ROWS
<p>TUCK STITCH PATTERN MULTI-COLOUR TUCK STITCH PATTERN</p> <p><input type="checkbox"/> ... Tuck Stitch <input checked="" type="checkbox"/> ... Stocking Stitch</p>	<p>You can't have two tuck stitches together.</p>	<p>(1) When you want stocking stitch between 2 rows of 1 x 1 tuck stitch. * Don't repeat the 1 x 1 tuck stitch more than 4 times, or have at least 4 stocking stitches between the 1 x 1 tuck stitches.</p>
<p>PLATED TUCK STITCH PATTERN</p> <p><input type="checkbox"/> ... Tuck Stitch</p>	<p>You can't have two tuck stitches together.</p>	<p>(2) Don't pull up the stitches more than 4 rows, or for 3 or 4 row tuck stitch pattern, have at least 3 stocking stitches between the tuck stitches.</p>
<p>WEAVING PATTERN</p> <p><input checked="" type="checkbox"/> ... Knitted by needle selected to D position</p>	<p>Don't weave the yarn more than five stitches.</p>	<p>You can only pull up the stitch one row.</p>
<p>THREAD LACE PATTERN</p> <p><input checked="" type="checkbox"/> ... Knitted by needle selected to D position</p>	<p>Don't select more than 5 needles to D position.</p>	<p>Don't try to transfer the same stitch over more than one row.</p>
<p>LACE PATTERN FINE LACE PATTERN</p> <p><input checked="" type="checkbox"/> ... Transferred Stitch</p>	<p>You can't transfer two stitches together.</p>	<p>Don't try to transfer 2 stitches diagonally.</p>
<p>MULTI-COLOUR RIB</p>	<ul style="list-style-type: none"> <li>• In order to use the KRC Key, make the pattern in the same way as for ordinary single bed fairisle. Make the pattern with even rows, and change the yarn on the even rows using the KRC.</li> </ul>	

# HOW TO CHECK THE PROGRAM FOR YOUR OWN PATTERNS

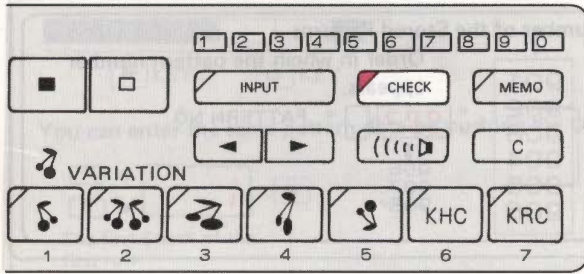

- You can check the pattern number, stitches, rows and pattern data for your own patterns stored in the computer.
- You can also change the pattern data.

## HOW TO CHECK YOUR PROGRAM

### (1) HOW TO CHECK THE PATTERN NUMBERS YOU HAVE STORED IN THE COMPUTER.

- When you push the DOWN Key, the Display shows the pattern numbers in order, beginning with the last one stored in the computer.

Ex.

The example shown supposes you stored patterns in the following order.



- (1) When the READY Lamp is lit, push the CHECK Key. The READY Lamp goes off.

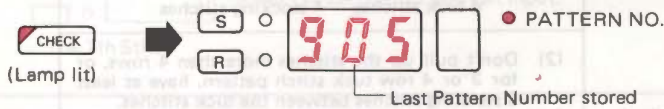

- (2) Push the DOWN Key.



As you push the DOWN Key, the Display shows the Pattern Numbers in the order they were entered, starting with the final number (e.g., 904-902-901-905).

- (3) Push the CHECK Key after you have checked the pattern number.

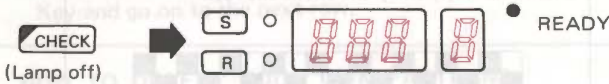

\* The READY Lamp is lit and the program check complete.

\* The Display and the Memo Display show the previous pattern program as it was before you began your program check at Step (1).

### (2) CHECK THE PATTERN DATA YOU HAVE STORED IN THE COMPUTER

METHOD 1: Check the pattern data with the Data Lamp. .... 1 2 3 4 5 6 7 8 9 0

METHOD 2: Check the pattern data with the Buzzer..... (( ))

Ex.

This example was knitted using Pattern No. 901.

DESIGN

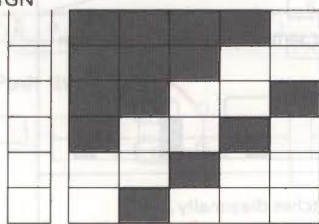

6 Rows

5 Stitches

You begin the same for both method 1 and method 2.

- (1) When the READY Lamp is lit, push the CHECK Key. The READY Lamp goes off.

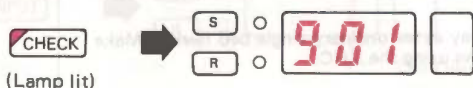

The Display shows the last pattern number. To display the pattern number you want to check, push the DOWN Key.

(2) Push the Step Key.

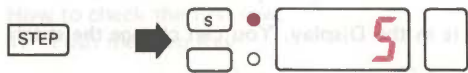

The Yellow Lamp is lit and the Display shows the number of stitches for the pattern. (You cannot change this.)

(3) Push the Step Key.



The Green Lamp is lit and the Display shows the number of rows for the pattern. (You cannot change this.)

For Method 2, please refer now to page 65.

**Method 1: How to check the pattern data using the Data Lamp.**

(4) To check the first row: Push the Step Key.

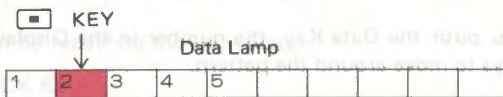
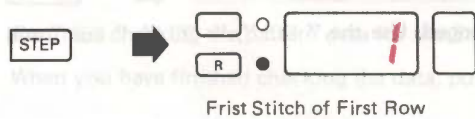

The Data Lamp shows the pattern data entered for the 1st – 10th stitch. Our example is a 5 stitch pattern, so the Data Lamps show the pattern data for 5 stitches.

(5) To check the 2nd row: Push the UP Key to advance the row number to the next row.



The Data Lamps shows the pattern data entered for the 1st – 5th stitch of the 2nd row.

(6) Repeat these Steps to check the pattern data for the 3rd – 6th row.



The Data Lamps show the pattern data entered for the first – 5th stitch of the 6th row.

(7) Check the pattern data, then push the CHECK Key.

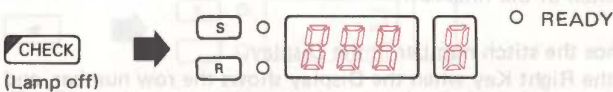

\* The READY Lamp is lit and the program check is completed.

\* The Display and the Memo Display show the previous pattern program as it was before you began your program check at Step (1).

\* You can finish the program check whenever you wish by turning off the Check Key.

**How to use the Data Lamps when the pattern has more than 10 stitches in one row.**

Example: a row with 14 stitches.



(1) When the Display shows the first stitch of the first row, the Data Lamps refer to the pattern data for stitches 1 – 10.

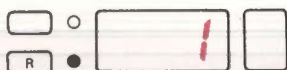

Pattern Data for 10 stitches

(2) If you advance the stitch number in the Display to 11 by pushing the Right Key, the Data Lamps refer to the pattern data for stitches the next 10 stitches, i.e. stitches 11 – 20.

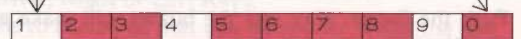

The example has 14 stitches, so the Data Lamps indicate the pattern data from the 11th–14th stitches.

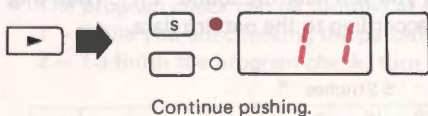

Continue pushing.

**What to do when you find a mistake in the middle of a program.**

- Using the Right or Left Key, move along the row so that the number is in the Display. You can change the stitch programmed for the number with the "□" or the "□" Key.

Example: Change the pattern data for the 3rd stitch.

- Push the Right Key "▶" to advance the number in the Display to the 3rd stitch.

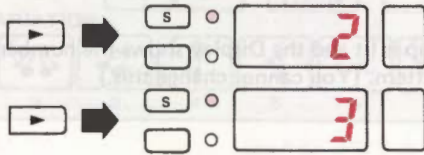

- Enter the pattern data for the 3rd stitch with the "□" Key.

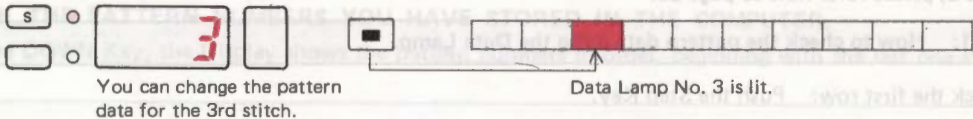

- Even if you push the Data Key, the number in the Display is not changed. Use the "▲", "▼", "▶" and "◀" Keys to move around the pattern.

- The indication in the Display is changed when you push the "▲", "▼", "▶" or "◀" Keys. (Pattern data for the number indicated in the Display can be changed with the "□" or "□" Key.)

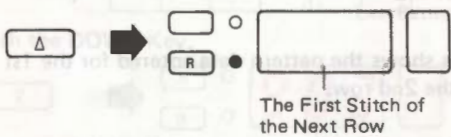

- Advance the row number in the Display.
- When you push the UP Key, the Display shows the first stitch of the next row.
- If you push the UP Key when the Display shows the final row of the pattern, then the number in the Display will be the first stitch of the first row.

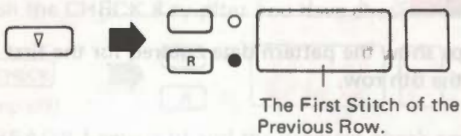

- Turn back the row number in the Display.
- When you push the DOWN Key, the Display shows the first stitch of the previous row.
- If you push the DOWN Key when the Display shows the first row of the pattern, then the number in the Display will go back to the first stitch of the final row.

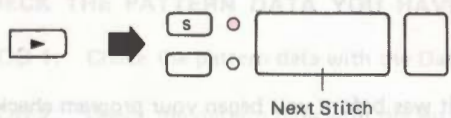

- Advance the stitch number in the Display.
- Push the Right Key when the Display shows the row number, and the Display will show the 2nd stitch of the same row.
- Push the Right Key when the Display shows the last stitch of the row, and the Display will show the first stitch of the same row.

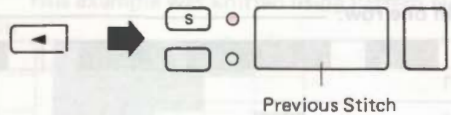

- Turn back the stitch number in the Display.
- Push the Left Key when the Display shows the row number, and the Display will show the last stitch of the same row.

**Method 2: How to check the Pattern Data using the Buzzer.**

Push the Buzzer Key and the buzzer will make a sound according to the pattern data for the row, from the number in the Display to the end of the row.

- Sound of the buzzer

■ ..... Pi ! Pi ! (2 short notes)

□ ..... Pee ! (One long note)

- How to check the pattern data.

Push the Buzzer Key and you will hear the sound "Pi!". Then the buzzer will make sounds according to the pattern data.

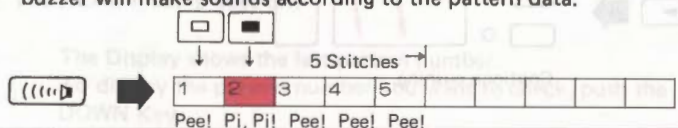

(4) Work Steps (1) – (3) on page 63.

How to check the first row.

1) Push the Step Key.

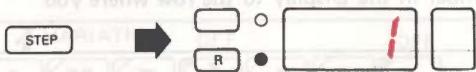

The Buzzer will make a sound according to the pattern data for the first stitch of the first row.

2) Push the Buzzer Key. The Buzzer now makes a series of appropriate sounds to enable you to check the pattern data.

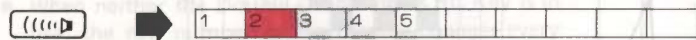

(5) How to check the 2nd row.

1) Push the UP Key to advance the row number.

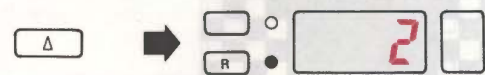

The Buzzer will make a sound according to the pattern data for the first stitch of the 2nd row.

2) Push the Buzzer Key. The Buzzer now makes a series of appropriate sounds to enable you to check the pattern data.

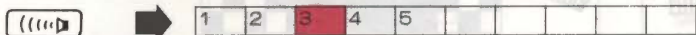

(6) Continue checking the pattern data for the 3rd to 6th row by repeating the steps above.

(7) When you have finished checking the data, push the CHECK Key.

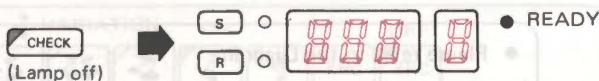

\* The READY Lamp is lit and the program check is completed.

\* The Display and the Memo Display show the previous pattern program as it was before you began your program check at Step (1).

What to do if you find a mistake in the middle of your program.

(1) Push the Buzzer Key to stop the sound.

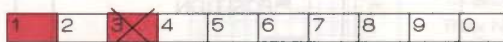
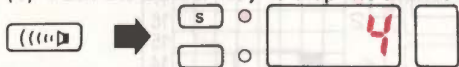

Check with the Data Lamps and your Design Sheet to find the mistake. (Example: 3rd stitch)

(2) Push the Left Key to move the indication in the Display back to the stitch you want to change. (Example: 3rd stitch)

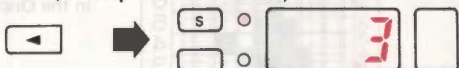

\* You can now change the pattern data which is indicated in the Display.

(3) Enter the correct pattern data for the 3rd stitch.

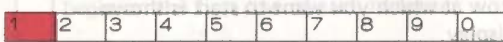

You can change the 3rd stitch.

Data Lamp No. 3 goes off.

(4) Push the Buzzer Key. The Buzzer will make the appropriate sounds beginning with the stitch number in the Display.

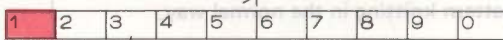

Peel! Peel! Peel!

- You can change the indication in the Display by pushing the UP, DOWN, Right or Left Keys.
- Move the number in the Display to the particular position you want to check, so that you need only check the pattern data for that part.
- Push the Buzzer Key if you want to stop the sound of the Buzzer.
- The program check can be finished at any time.
  - 1 – While you are checking the pattern data with the Buzzer, use the Buzzer Key to stop the sound.
  - 2 – To finish the program check, turn off the Check Key.



# SPECIAL PROGRAM

## ● HOW TO BEGIN KNITTING MIDWAY THROUGH A PATTERN

You don't always have to start your pattern on Row 1. Advance the number in the Display to the row where you want to begin by pushing the UP or DOWN Key.

Ex.

- Begin the pattern in a different place so that the sleeves and body match.
- The example is worked with "STITCH WORLD" Pattern No. 1.

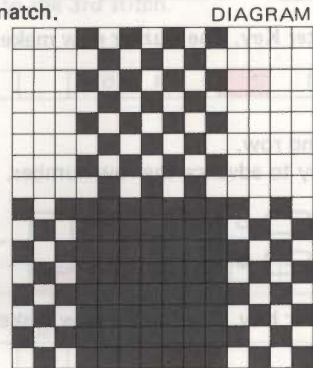
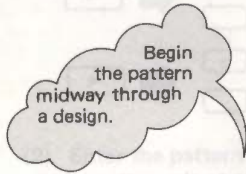

### ■ How to program

#### ❓ VARIATION

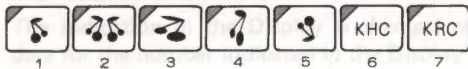

#### SELECTOR

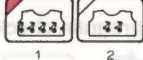

○  ○  ● PATTERN NO.

○  ○  ● POSITION

- (1) Program the pattern as shown above. The READY Lamp is now lit and number 1 appears in the Display.

○  ○  ● READY

Needle selection begins from the 1st row.

- (2) Push the UP or DOWN Key until the number for the row at which you want to start is shown in the Display.

○  ○  ● READY

Needle selection begins from the 11th row.

\*Continue pattern knitting in the normal way.

- When working in Lace or Fine Lace Pattern, take care over the following point.

- Please refer to the Diagram.

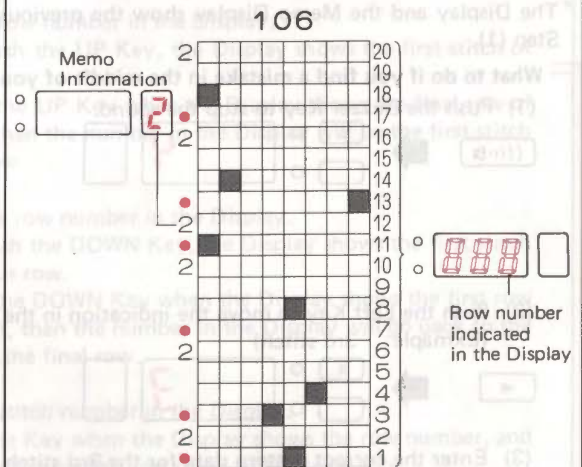

\*You can begin knitting from one row above the ones with the memo number (i.e. those marked with ●).

• **What to do when using the Double Length Key or KRC Key.**

The computer arranges the pattern data as follows, depending upon the setting of the Variation Key. The indication of the row number in the Display is different when you use the Double Length or the KRC Key.

• When neither the Double Length nor KRC Key is in use; the row number in the Display changes every row.

Keep on pushing.

Row Number in the Display.

When you use the KRC Key; one row knitted with main yarn and one row knitted with contrast yarn equal one complete row of Multi-colour rib pattern. Therefore the Display shows the same row number twice.

Row Number in the Display.

\* When you start knitting Multi-colour Rib from midway through a pattern, begin from the first row of the odd-numbered rows, because 4 rows equal one pattern sequence.

• When using the Double Length Key; the same row is knitted twice with Double Length Pattern, so the Display will show the same number twice.

Keep on pushing.

Row Number in the Display.

When using the Double Length Key and the KRC Key; the Display shows the same number 4 times.

Row Number in the Display.

\* When you start knitting from midway through a pattern, begin on the first row of each number.

● **HOW TO KNIT SEVERAL ROWS OF STOCKING STITCH BETWEEN PATTERN KNITTING**

Use the **START** Key.

Ex.

This fairisle example was knitted using "STITCH WORLD" Pattern No. 60.

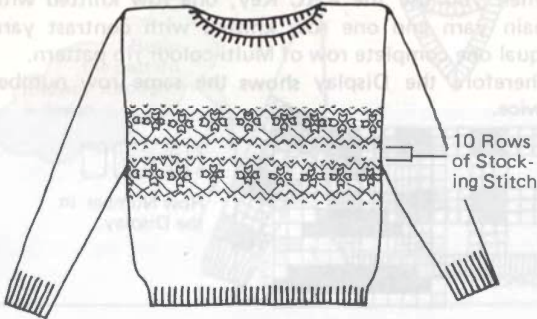

How to knit 10 rows of stocking stitch between the pattern knitting.

● **How to knit.**

(1) Program the pattern as follows and knit the 1st pattern.

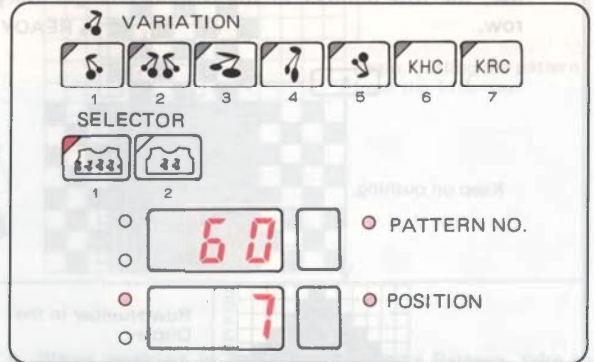

(2) Now set the Change Knob to N.L. Take the contrast yarn out of Yarn Feeder "B". Knit 9 rows of stocking stitch and place the K-Carriage outside the Turn Mark. The last (10th) row is the needle selection row for the first row of the next pattern.

(3) Check the information shown in the Display. (Lamp is flashing on and off.)



This indicates the needle selection for the first row has been done.



This indicates the needle selection for the first row needs to be done.

(4) Make sure the K-Carriage is outside the Turn Mark. Now set the Change Knob to KC (I) and knit one row. The needles are selected for the first row of the next pattern.

(5) Push the MC Button and thread the contrast yarn into Yarn Feeder "B". Now knit the second pattern.

● **How to begin knitting the pattern from Row 1 when the display indicates another row number**

Needle selection for the first row will be done by pushing the **START** Key.

Ex.

(1) The 3rd row is indicated in the Display  
(The Display tells you to knit the 3rd row.)



(2) Push the **START** Key.  
(The Display now indicates the first row.)



(The needle selection will be according to the first row of the pattern.)

## • THE FUNCTION OF THE START KEY

When you push the START Key, even if the Display indicates any other row number in the pattern, it will change to Row 1. Needle selection will also be according to the first row of your pattern.

### ► HOW TO GET BACK TO ROW 1

- When you want to begin a new piece of knitting, but haven't changed the pattern number, (e.g. if you are making the parts of a garment) the Display will show the number for the row you are going to knit in pattern. To get back to the first row of your pattern, push the START Key and the number in the Display will revert to 1.
- You must always select the needles first before your start pattern knitting.
- When the number in the Display is flashing on and off, it means the needle selection has been done. Return the Display to number 1 by pushing the START Key. The flashing will cease, and the needles will be selected according to Row 1 of the pattern.

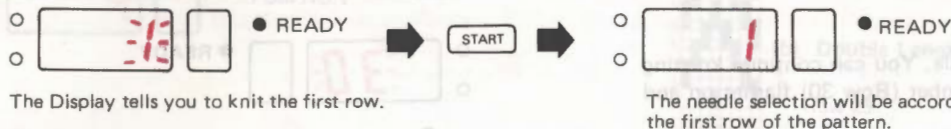

## HOW TO CHANGE A VARIATION KEY WHILST YOU ARE KNITTING IN PATTERN

- The Variation Keys can be changed whenever you wish, even if you are in the middle of a pattern.

### How to change the Reverse, Double Width, Mirror Image, Upside Down or KHC Keys.

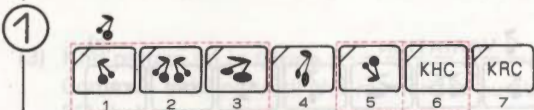

- Change the Variation Key one row before you want the pattern to be altered.
- Change the program in this way anywhere on the pattern to create different effects.

Ex.

This example was knitted using "STITCH WORLD" fairisle Pattern No. 54.



- Change the Reverse Key for each pattern as follows:—

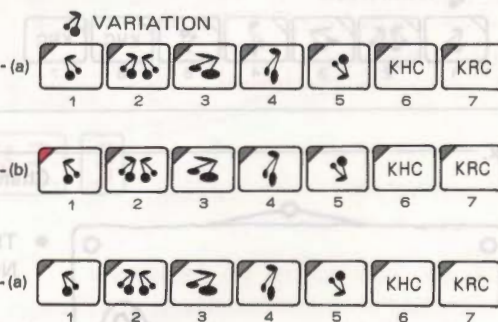

- How to knit.

(1) Program pattern (a) as follows:

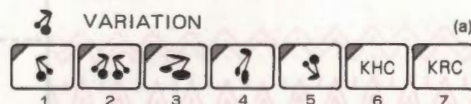

SELECTOR

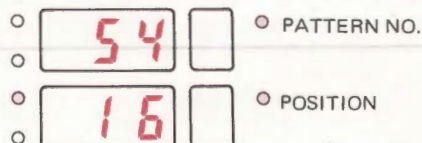
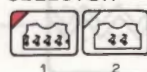

(2) Look at the Diagram for the pattern in "STITCH WORLD", and make a note of the number of the row before that on which you want to change the pattern.

\* In our example, the pattern would be changed on row 1 (i.e. the first row of the next pattern repeat), so one row before the final pattern row would be row 30.

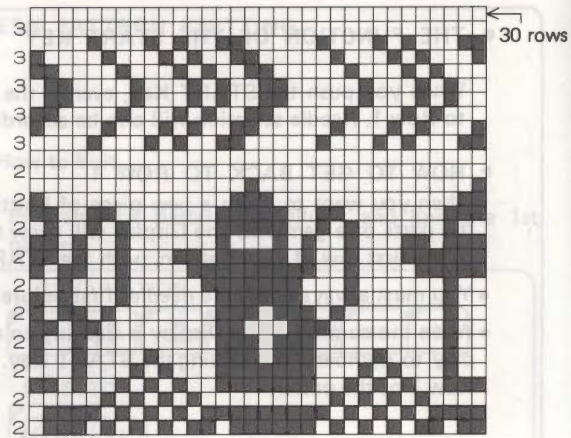

You can use the Memo Display to memorize the row number for the change. Use the Memo Program to indicate the 30th row in the Memo Display. (Refer to p. 52.)

(3) Knit pattern (a) in fairisle. You can continue knitting until the memorized number (Row 30) flashes on and off in the Display.

(4) Now change the Variation Key (or the pattern program).

(5) When you operate the K-Carriage for the next row, the needles are selected for the first row of pattern (b). Continue to knit until the memorized number (Row 30) flashes on and off again in the Display.

(6) Now change the Variation Key (or the pattern program) again.

(7) When you operate the K-Carriage for the next row, the needles are selected for the first row of pattern (a).

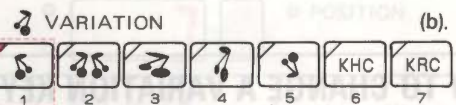
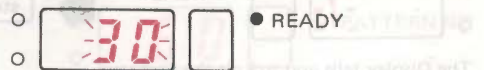

(Turn on the Reverse Key)

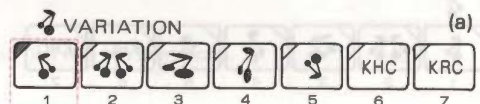

(Turn off the Reverse Key)

### How to change the Double Length Key.

2

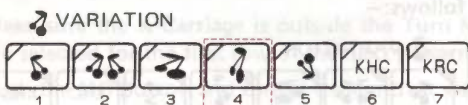

● Change the Variation Key on the row you want the pattern to be altered.

Ex.

Change the Double Length Key in the middle of the pattern as follows:

● This example was knitted using "STITCH WORLD" fairisle Pattern No. 73.

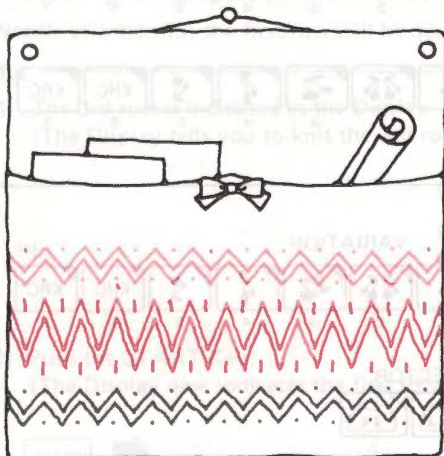

● **How to knit.**

(1) Program pattern (a) as follows:—

**VARIATION (a)**

**SELECTOR**

● **PATTERN NO.** 73

● **POSITION** 4

(2)



Look at the Diagram for the pattern in "STITCH WORLD", and make a note of the number of the row on which you want to change the pattern.

\* In our example, knit the design by changing the Double Length Key at Row 25 (Key on) and Row 43 (Key off).

(a) Double Length Key off.

Row 43

(b) Double Length Key on.

Row 25

(a) Double Length Key on.

Row 1

(3) Knit pattern (a) in fairisle.-----

Continue knitting until the memorized number (Row 25) flashes on and off in the Display.

(4) Turn on the Double Length Key.-----

The pattern is changed to the new setting (b) on the row where the needles have already been selected. You can begin knitting pattern (b).

**VARIATION (b)**

(5) Operate the K-Carriage.-----

Continue knitting until row number (Row 43) flashes on and off in the Display.

(6) Turn off the Double Length Key.-----

The pattern is changed to the new setting (a) on the row where the needles have already been selected. You can begin knitting pattern (a).

**VARIATION (a)**

(7) Operate the K-Carriage and knit pattern (a).

# FLOPPY DISC DRIVE UNIT FB-100

## AN INTRODUCTION TO THE FLOPPY DISC

In your machine there are 555 stitch pattern designs built into the memory (they are shown in the "STITCH WORLD" book). There is also another, quite separate memory in your machine called "RAM" which allows you to program your own stitch pattern designs.

Once you have programmed your own stitch pattern design, you will want to keep it safe for the future. If there is enough room in the "RAM", you can leave your stitch pattern design there, knowing it to be safe. If there is not enough room in the "RAM", you will need to store that information on a disc which you can use time and time again.

The floppy disc has 2 tracks and each track will store all the stitch pattern information – "data" – which are in the "RAM". So that the computer can identify which track on the disc you require, the tracks are numbered 1–2, but you must keep a record yourself of what each track and disc contains.

Floppy discs are used to store many different types of information, but we want ours to store information from our knitting machine, and so we must prepare the disc to accept that information. In order to do this we must "format" our discs. Once we have done this, the disc will accept information from the knitting machine quite happily. The knitting machine cannot work from the disc directly. The stitch pattern information – "data" – on a track must be transferred back into the memory of the knitting machine before the knitting machine can act. In order to transfer the data back and forth from knitting machine to disc, you must tell the machine what you want to do.

These instructions or commands are built into the memory already under a code number:–

To format your disc – 550

To transfer your data onto disc – 552

To transfer your data from disc to knitting machine – 551

To delete the data from a track – 553

## PART NAMES

### • 3.5 inch floppy disc drive unit

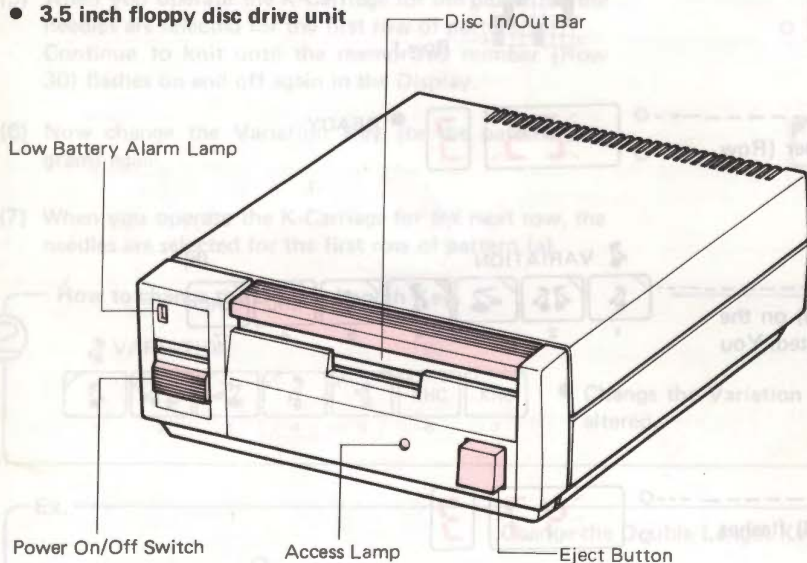

### • 3.5 inch floppy disc

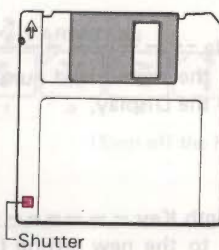

### • Interface cable

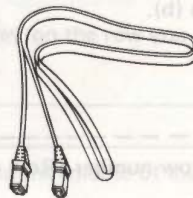

### • 4 Batteries

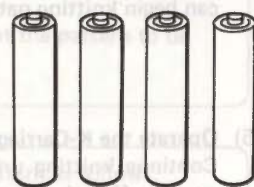

### • BEFORE YOU BEGIN TO PROGRAM

\*Please read the leaflet accompanying the Floppy Disc Drive Unit before you connect it to the power.

### CONNECT THE FLOPPY DISC DRIVE UNIT TO THE ELECTRONIC KNITTING MACHINE

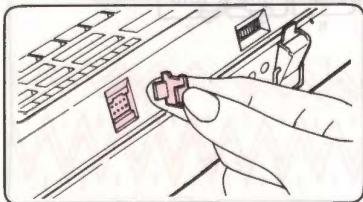

(1) Make sure the power to both the knitting machine and the Floppy Disc Drive unit is turned OFF.

(2) Remove the connector cover at the back of the pattern case on the knitting machine.

\*When you do not use the Floppy Disc Drive, fit the connector cover to the machine.

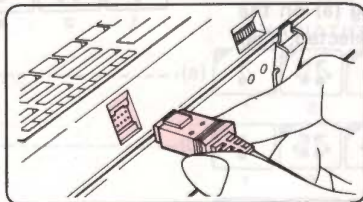

(3) Plug the interface cable into the knitting machine as shown.

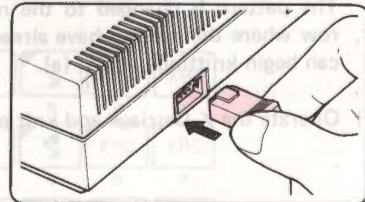

(4) Plug the other end of the interface cable into the Floppy Disc Drive unit as shown.

- Make sure that the disk is not set in the unit and the Disk In/Out Bar is pushed down before you turn on or off the power switch.
- NOTE: In order not to waste the battery energy, turn off the power switch of the unit after finishing program (initialization, saving, loading, deletion).
- If you take out the disk or pull out the interface cable while the access lamp is lighting on, the knitting machine sometimes will not work. In this case turn off the power switch of both the unit and knitting machine, and then start from the beginning again.

## HOW TO FORMAT YOUR DISCS

550

- Before you can use a new disc to store pattern information from your electronic knitting machine, you need to prepare the new disc to make it ready to accept your data. This preparation process is called "formatting". Remember to do this for every new disc.

CAUTION: If you format a disc that has pattern data already stored on it, this data will be erased.

### STEP 1

After turning on the Power Switch of the Unit set the disk into the Unit.

\* Refer to the Instruction Manual for Floppy Disc Drive.

### STEP 2

Turn on the knitting machine power switch. (Make sure the READY Lamp is lit.)

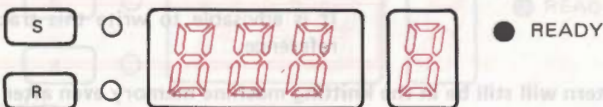
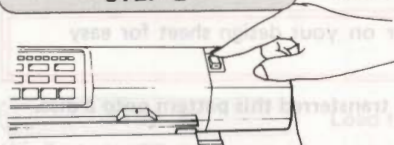

### STEP 3

Format the disc.

- (1) Push the CE Key to clear the Display.

CE

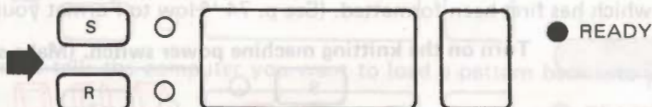

- (2) Enter the Command Number 550 as the formatting number.

5 5 0

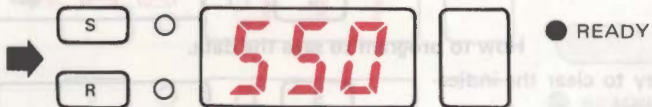

- (3) Push the Step Key.

STEP

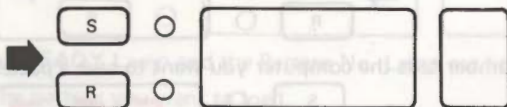

When you push the Step Key, the indication in the Display and all the lamps go off, and the computer begins to format the disc.

\* It takes about 100 seconds to finish formatting.

- (4) When formatting is finished, the buzzer sounds "Pi!" and the indication lamps are as they were before you pushed the CE Key at Step 3-(1) above.

Formatting is finished.

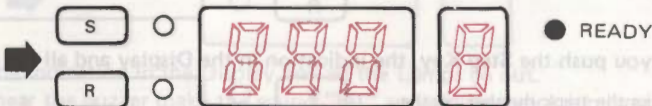

\*When "E" appears in the Memo Display, refer to p. 164.

1 E



# HOW TO SAVE YOUR PATTERN DATA

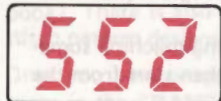

- **Use the disc of which formatting is finished.**  
You can store on disc the data which has been memorised by your electronic knitting machine. Before you can begin to store this data, it must first be entered and stored in the knitting machine memory. (See p. 57 "Input Program for your own Patterns".)  
Once the pattern is stored in the knitting machine memory, it can be transferred from there onto the disc.
- **Information that can be saved on disc.**  
All the pattern data and memo information relating to a pattern entered into the computer in your knitting machine can be stored on disc. This includes the following:—
  - 1) Pattern number.
  - 2) Position of the Selector.
  - 3) Pattern position for Selector (1) setting.
  - 4) Pattern position and number of pattern repeats for each motif for Selector (2) setting.
  - 5) Variation Key settings.
  - 6) Memo Display information.

Row numbers and Memo Key information can also be saved.

- **Capacity of the Disc.**
  - There are 2 tracks on each disc, and one track is used to save all data in the RAM.

Think of each track as a drawer in the disc, into which you can store a pattern.

When a pattern is too long to be memorised in the computer in one go, you can divide it into two parts. Then enter each part onto a floppy disc. To knit the pattern, load the discs in sequence from the floppy disc drive unit into the computer.

- Each track is automatically given a number by the computer.

It is advisable to write this track number on your design sheet for easy reference.

- The data for a pattern will still be in the knitting machine memory even after you have transferred this pattern onto a disc.

**STEP 1** After turning on the Power Switch of the Unit set the disc into the Unit.

Only insert a disc which has first been formatted. (See p. 74 "How to Format your discs".)

**STEP 2** Turn on the knitting machine power switch. (Make sure the READY Lamp is lit.)

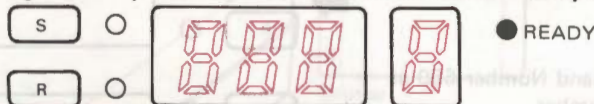

**STEP 3** How to program to save the data.

- (1) Push the CE Key to clear the indication in the Display.

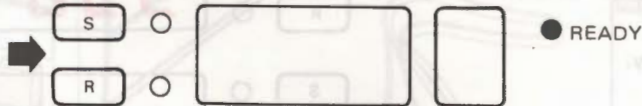

- (2) Enter the number 552. This number tells the computer you want to save a pattern on disc.

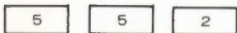

- (3) Push the Step Key.



- When you push the Step Key, the indication in the Display and all the lamps go out.

The computer checks the track number on the disc. The track number on which you can save the data is then shown in the Display. The READY Lamp and the Pattern No. Lamp are lit.



Disc track number on which you can save your pattern data.

The track number is used when you want to load your pattern data, so it is advisable to write this on your design sheet as well.

- (4) Push the Step Key.



- (5) When all the data has been stored, you will hear the buzzer make the sound "Pi!" and all the indication lamps are as they were before you pushed the CE Key.

When data storage is finished.

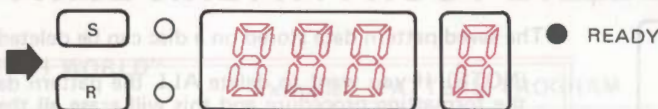

When "E" appears in the Memo Display, refer to p. 164.

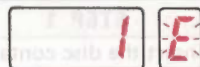

## HOW TO LOAD YOUR PATTERN DATA

- When you want to knit the saved pattern data you have stored on one track of a disc, you need to load it back into your knitting machine.

NOTE: The Command Number for loading pattern data back into your knitting machine is 551.

REMARK: When loading the pattern data onto the knitting machine, all the pattern data in the memory of the knitting machine will be deleted. (except "Stitch World" pattern)

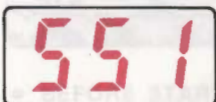

### STEP 1

After turning on the Power Switch of the Unit set the disk into the Unit.

Insert the disc containing the data for the pattern you wish to load.

### STEP 2

Turn on the knitting machine power switch. (Make sure the READY Lamp is lit.)

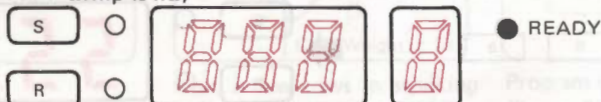

### STEP 3

Load the pattern data.

- (1) Push the CE Key to clear the indication in the Display.

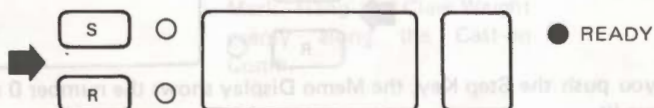

- (2) Enter Command Number 551. This number tells the computer you want to load a pattern back into your knitting machine.

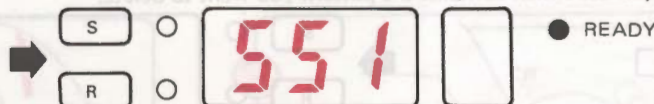
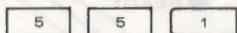

- (3) Push the Step Key.



- When you push the Step Key, the READY Lamp and the Pattern No. Lamp are lit.

- (4) Enter the track number which contains the pattern you want to load.

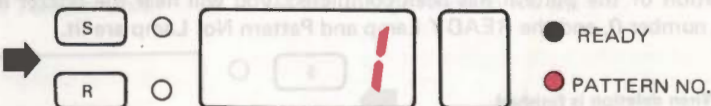

- (5) Push the Step Key.



- When you push the Step Key, the indication in the Display and all the Lamps go out.

- (6) When pattern has been loaded, you will hear the buzzer make the sound "Pi!" and all the indication lamps are set according to the data you have just stored.

When data loading is finished.

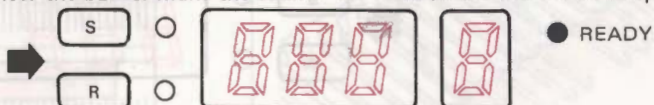

Even if you turn off the power switch of the unit after finishing the program for load, you can knit the pattern you load by pattern program.

When "E" appears in the Memo Display, refer to p. 164.

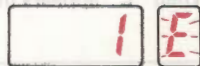

# HOW TO DELETE YOUR PATTERN DATA



The saved pattern data stored on a disc can be deleted one track at a time.

(NOTE) If you want to delete ALL the pattern data stored on a disc, then carry out the formatting procedure and this will erase all the data (See p. 74 "How to Format your Discs").

## STEP 1

After turning on the Power Switch of the Unit set the disk into the Unit.

Insert the disc containing the data for the pattern you wish to delete.

## STEP 2

Turn on the knitting machine power switch. (Make sure the READY Lamp is lit.)



## STEP 3 Delete the pattern data.

- (1) Push the CE Key to clear the indication in the Display.

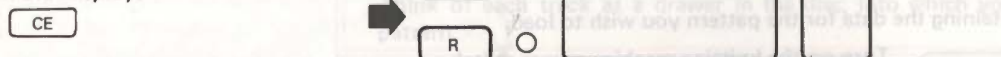

- (2) Enter Command Number 553. This number tells the computer you want to delete a pattern.

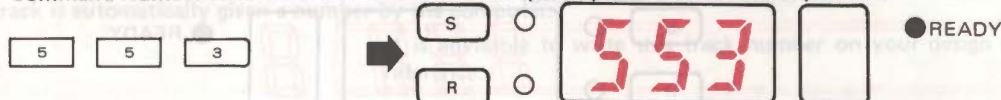

- (3) Push the Step Key.

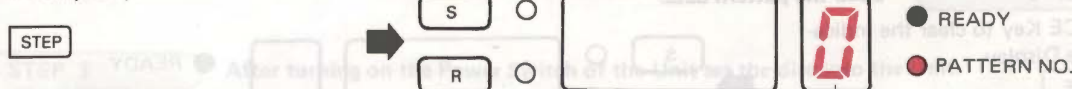

- When you push the Step Key, the Memo Display shows the number 0 and the READY Lamp and the Pattern No. Lamp are lit.

- (4) Enter the track number which contains the pattern you want to delete.

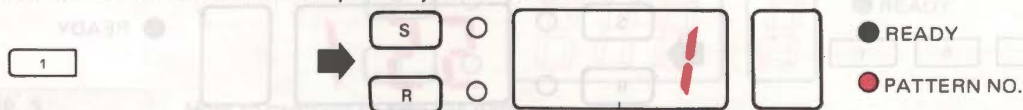

- (5) Push the Step Key.

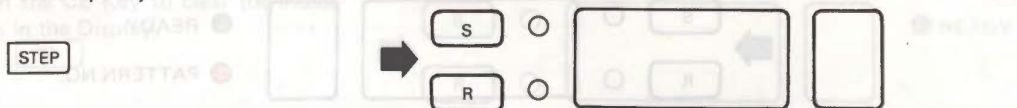

- When you push the Step Key, the indication in the Display and all the Lamps go off.

- (6) When deletion of the pattern has been completed, you will hear the buzzer make the sound "Pi!". The Display shows the number 0, and the READY Lamp and Pattern No. Lamp are lit.

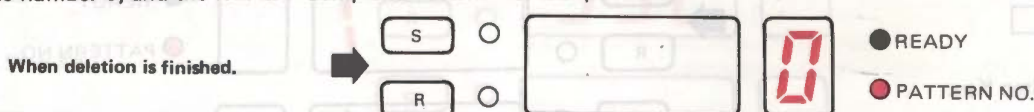

- By repeating Steps (4) – (6) you can delete as many patterns as you wish.

- (7) Push the Step Key when you want to end the program for pattern deletion. The indication lamps are as they were before you pushed the CE Key.

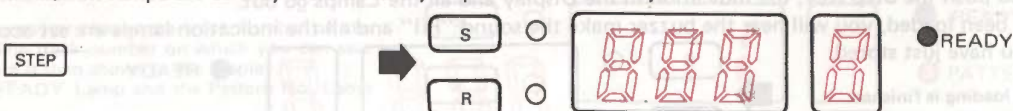

When "E" appears in the Memo Display, refer to p. 164.

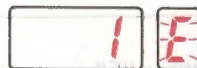

## FAIRISLE PATTERN SELECTOR (1)

- This example was knitted using "STITCH WORLD" Pattern No. 19.



### Example: PATTERN PROGRAM

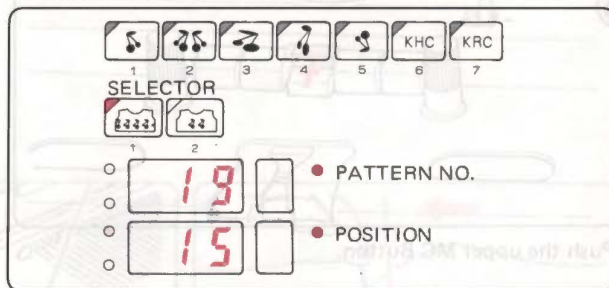

### • BEFORE STARTING PATTERN KNITTING

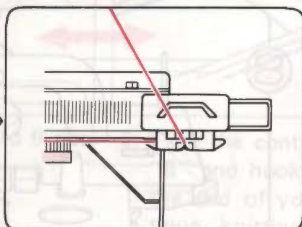
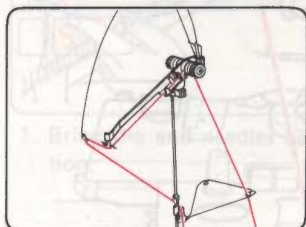

Cast on.

Thread the main yarn into the righthand Yarn Tension Unit.

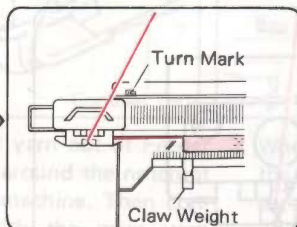

Knit a few rows in stocking stitch and place the K-Carriage outside the left Turn Mark. Hang the Claw Weight evenly along the Cast-on Comb.

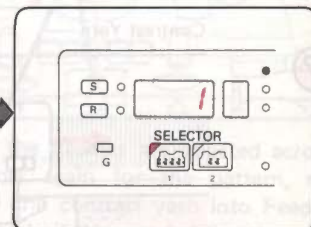

Program your pattern. (See p. 23.)

### • PATTERN KNITTING

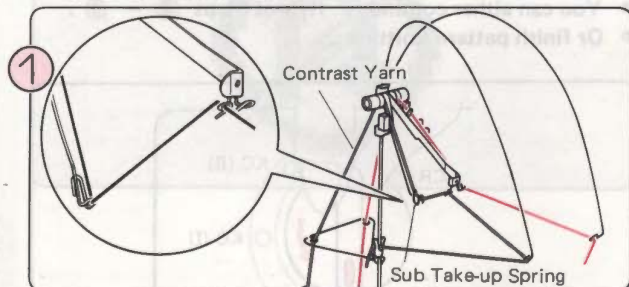

Thread the contrast yarn into the left Yarn Tension Unit, including the Sub Take-up Spring.

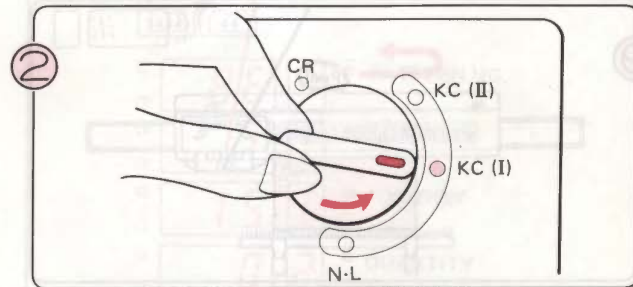

Set the Change Knob to KC (I).

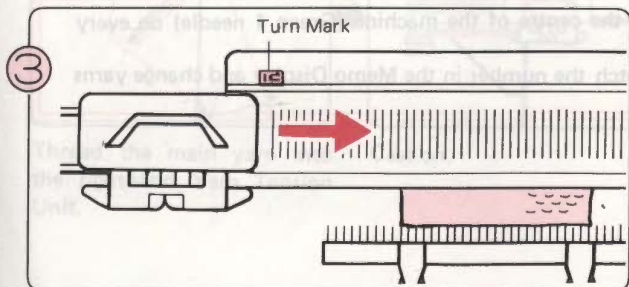

Move the K-Carriage from left to right across the left Turn Mark.

\*You only need to operate the K-Carriage once across the Turn Mark when you start pattern knitting.

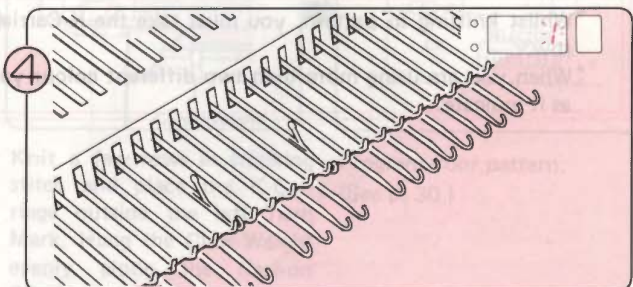

The needles are selected. Number 1 flashes on and off in the Display to tell you to knit the first row of the pattern.

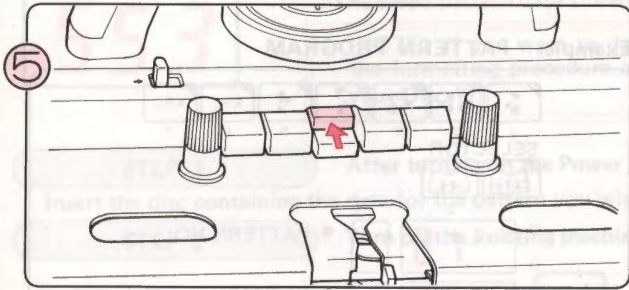

5 Push the upper MC Button.

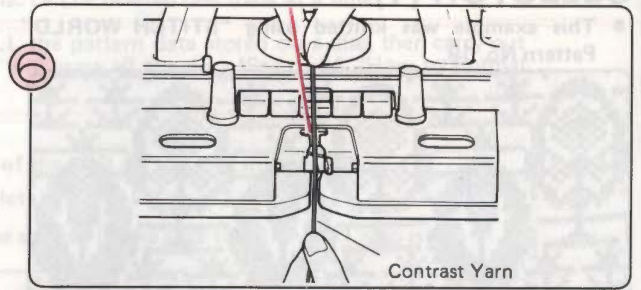

6 Thread the contrast yarn into Yarn Feeder "B" – there is no need to open the Yarn Feeder Lever when you do so.

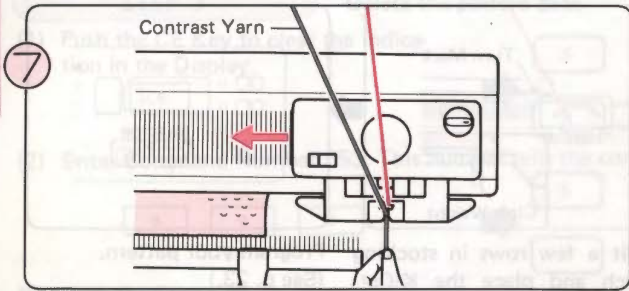

7 Holding the yarn end with your left hand, move the K-Carriage from right to left.

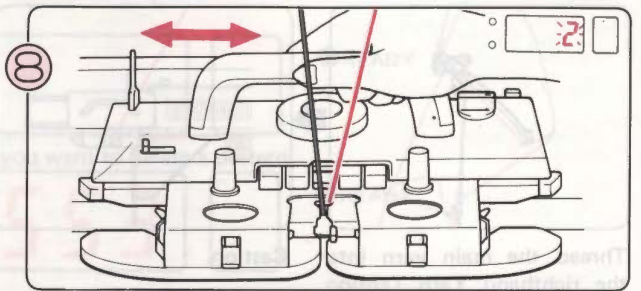

8 The Number 2 flashes on and off in the Display to tell you to knit the second row of the pattern. Move the K-Carriage to the right and then to the left. You are now knitting in Fairisle Pattern.

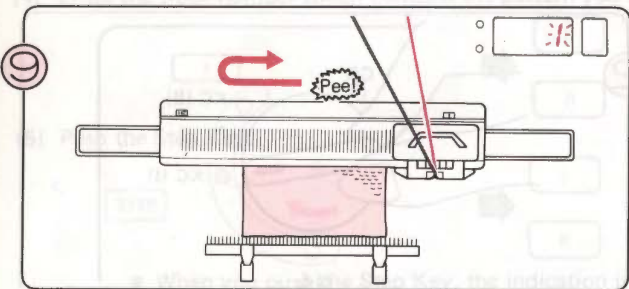

9 Knit in pattern until you hear the sound "Peel!". Finish the row and knit one more row. Number 1 flashes on and off in the Display. You have now knitted one complete pattern in length.

- You can either continue ... Repeat Steps 8 – 9 .
- Or finish pattern knitting ...

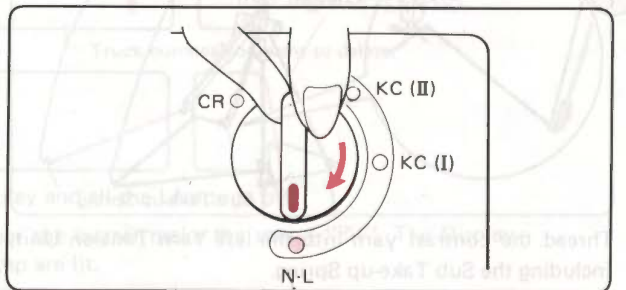

10 Set the Change Knob to N-L. The Cam Button will be released automatically.

\* Whilst knitting in pattern, you must take the K-Carriage past the centre of the machine (Green 1 needle) on every row.  
 \* When you are using more than two different colour yarns, watch the number in the Memo Display and change yarns as it indicates.

- If there are any rows where you use only the main yarn (i.e. no contrast colour) ...



The end needles only will be selected to D position.  
When this happens, you should do the following:—

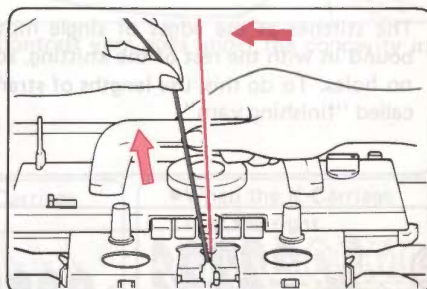
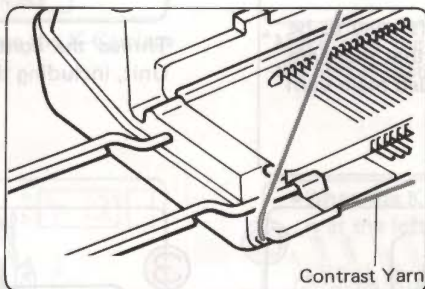
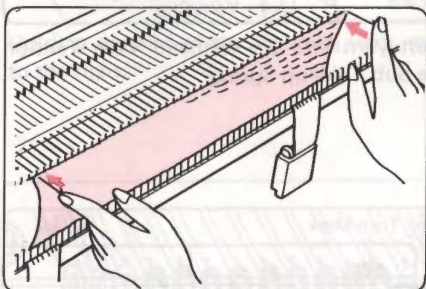

1. Bring the end needles back to B position.
2. Take the contrast yarn out of Feeder "B" and hook it around the notch at the end of your machine. Then continue knitting with the main yarn only, bringing the end needles back to B position on each row.
3. When the needles are selected across the row again for the pattern, re-thread the contrast yarn into Feeder "B" and knit the row, holding the contrast yarn as shown so that no loops form at the edges.

## SELECTOR (2)

This example was knitted using "STITCH WORLD" Pattern No. 86.



### Example: PATTERN PROGRAM

					KHC	KRC
1	2	3	4	5	6	7
SELECTOR						
1	2					
○		○	• PATTERN NO.			
○		○	• QUANTITY			
○		○	• POSITION			
○		○	• QUANTITY			

### • BEFORE STARTING PATTERN KNITTING

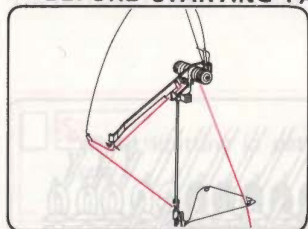

Thread the main yarn into the righthand Yarn Tension Unit.

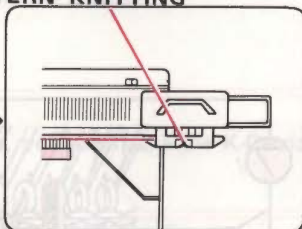

Cast on.

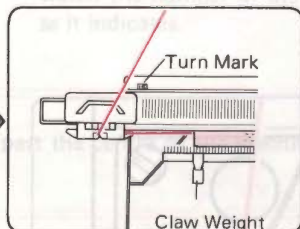

Knit a few rows in stocking stitch and place the K-Carriage outside the left Turn Mark. Hang the Claw Weight evenly along the Cast-on Comb.

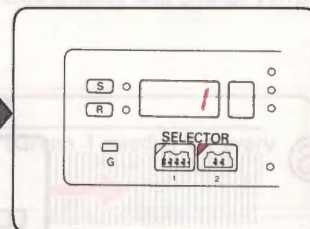

Program your pattern. (See p. 30.)

● **HOW TO KNIT SINGLE MOTIFS**

Separate the main yarn in two.

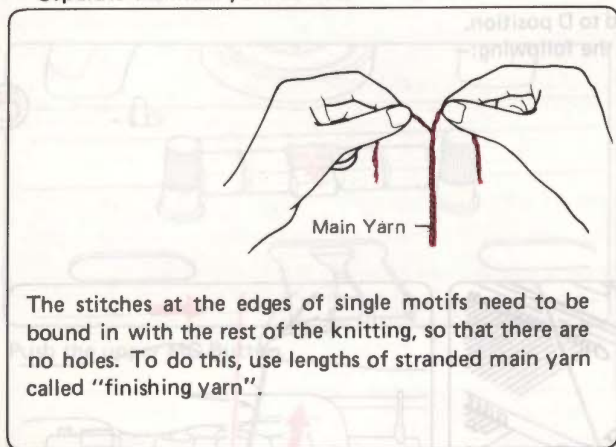

The stitches at the edges of single motifs need to be bound in with the rest of the knitting, so that there are no holes. To do this, use lengths of stranded main yarn called "finishing yarn".

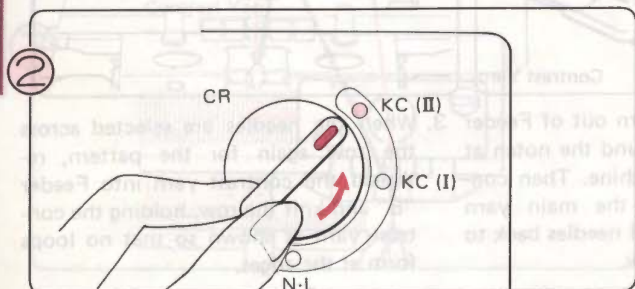

Set the Change Knob to KC (II).

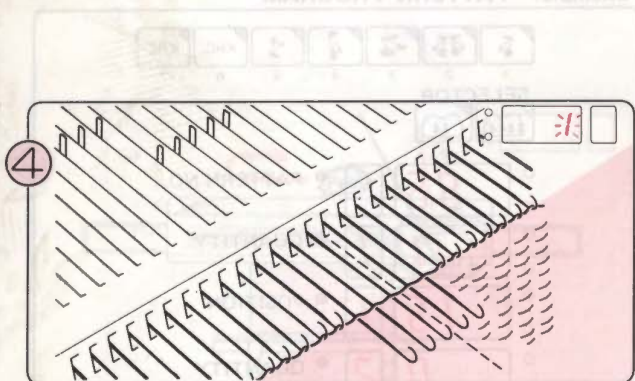

The needles are selected. Number 1 flashes on and off in the Display to tell you to knit the first row of the pattern.

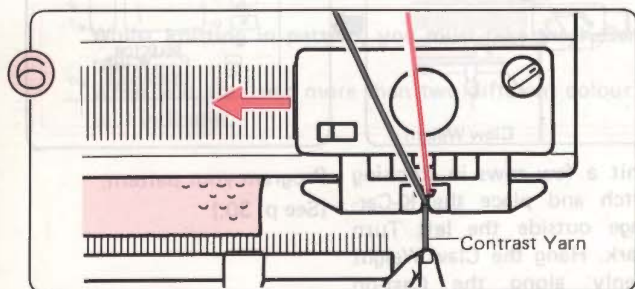

Thread the contrast yarn into Yarn Feeder "B" — there is no need to open the Yarn Feeder Lever when you do so. Move the K-Carriage from right to left.

● **PATTERN KNITTING**

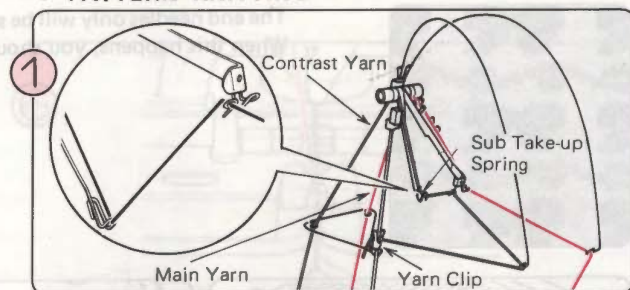

Thread the contrast yarn into the left-hand Yarn Tension Unit, including the Sub Take-up Spring.

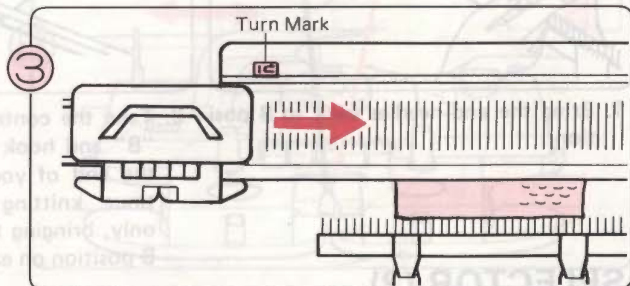

Move the K-Carriage from left to right across the left Turn Mark.

\* You only need to operate the K-Carriage once across the Turn Mark when you start pattern knitting.

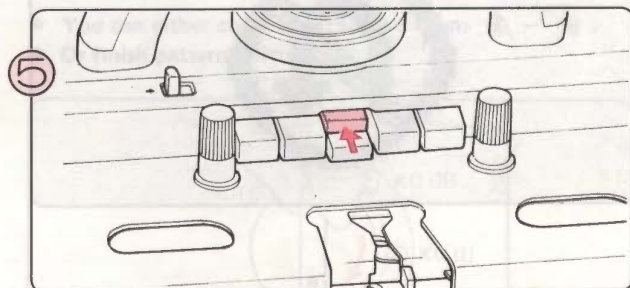

Push the upper MC Button.

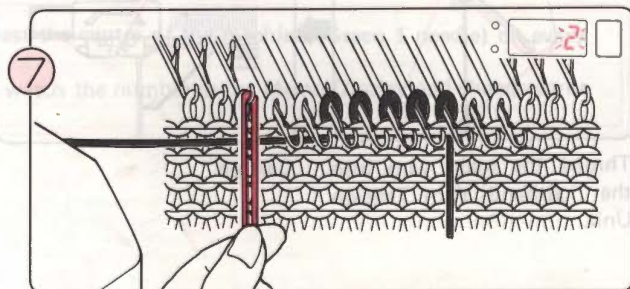

Fold a separate piece of finishing yarn in half, and place it over the needle adjacent to the last selected needle at the left.

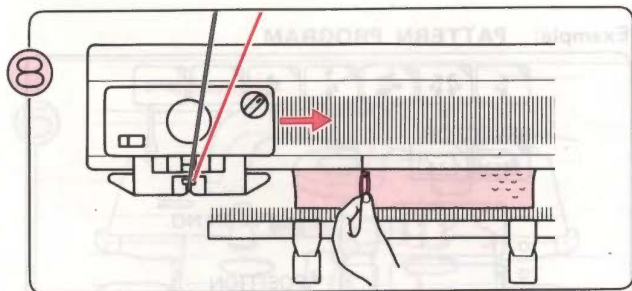

8 Holding the end of the finishing yarn, move the K-Carriage to the right.

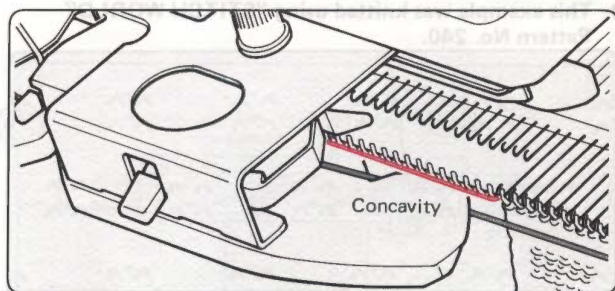

\*Make sure the contrast yarn goes under the concavity in the Sinker Plate.

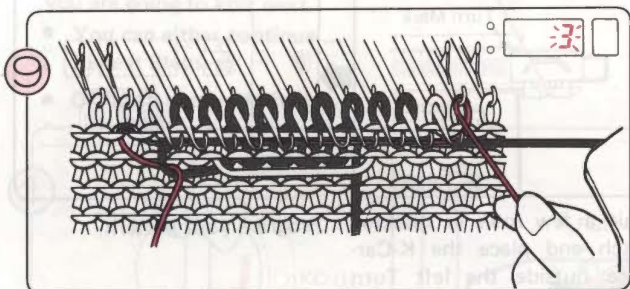

9 Take one end of the finishing yarn under the selected needles, and wrap it from right to left round the needle adjacent to the last selected needle on the right. (See illustration.) Holding the end of the finishing yarn, move the K-Carriage from right to left.

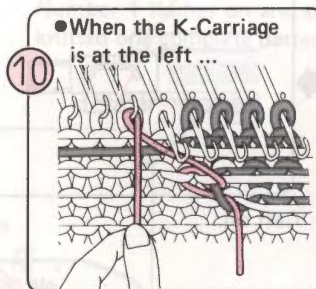

10 ●When the K-Carriage is at the left ...

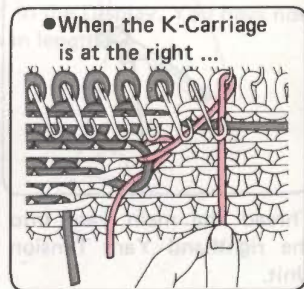

●When the K-Carriage is at the right ...

Wrap the finishing yarn around the hook of the needle adjacent to the first selected needle, and pull down gently.

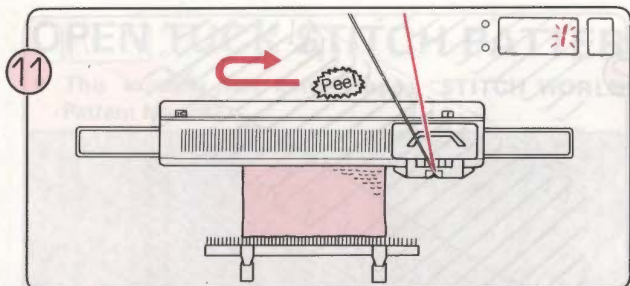

11 Knit in pattern until you hear the sound "Peel". If you are operating the K-Carriage from right to left when you hear the sound, finish that row and knit one more row. The number 1 flashes on and off in the Display.

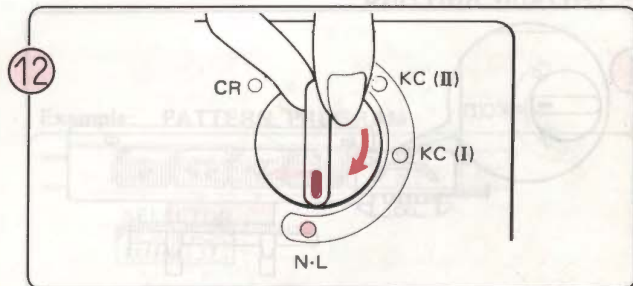

12 Set the Change Knob to N-L. The Cam Button will be automatically released.

\*When you are using more than two different colour yarns, watch the number in the Memo Display and change yarns as it indicates.

\*Whilst knitting in pattern, you must take the K-Carriage past the centre of the machine (Green 1 needle) on every row.



# TUCK STITCH PATTERN

- This example was knitted using "STITCH WORLD" Pattern No. 240.



## • BEFORE STARTING PATTERN KNITTING

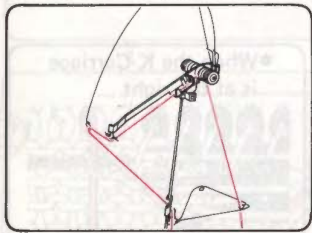

Thread the main yarn into the righthand Yarn Tension Unit.

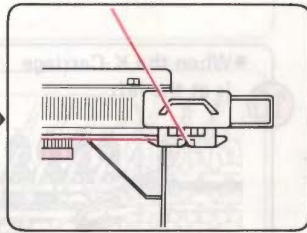

Cast on.

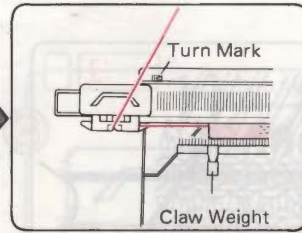

Knit a few rows in stocking stitch and place the K-Carriage outside the left Turn Mark.

Hang the Claw Weight evenly along the Cast-on Comb.

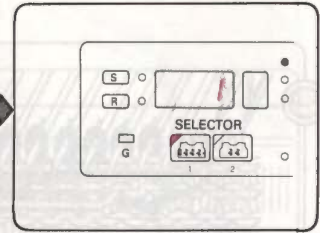

Program your pattern.

## • PATTERN KNITTING

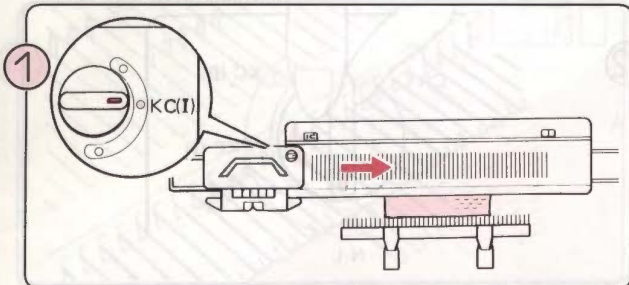

Set the Change Knob to KC (I). Move the K-Carriage from left to right across the left Turn Mark.

\*You only need to operate the K-Carriage once across the Turn Mark when you start pattern knitting.

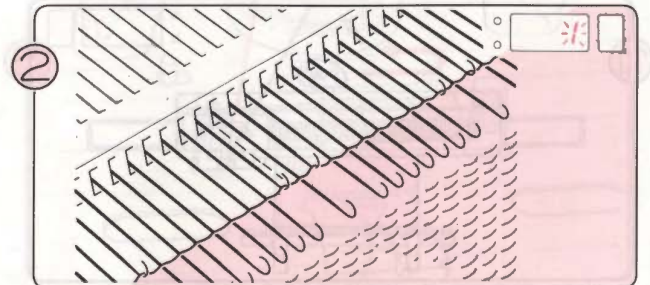

The needles are selected.

Number 1 flashes on and off in the Display to tell you to knit the first row of the pattern.

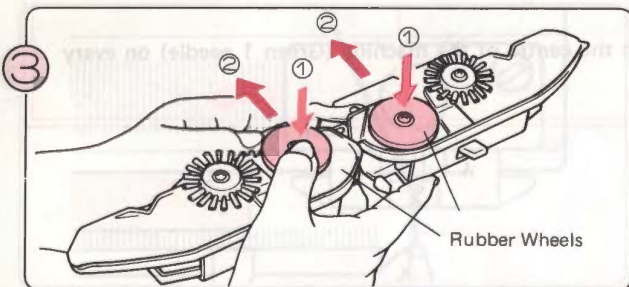

Remove the Sinker Plate Assembly from the K-Carriage and turn it over. Put the Rubber Wheels into working position ② as shown. Attach the Sinker Plate Assembly back on the K-Carriage again.

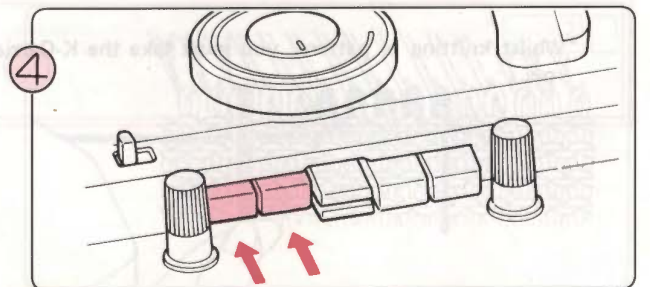

Push both Tuck Buttons at the same time.

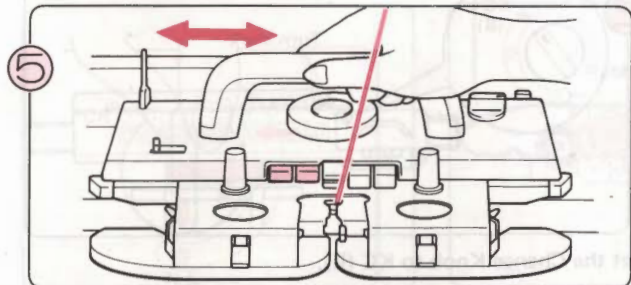

Move the K-Carriage back and forth. You are now knitting in Tuck Stitch Pattern.

The number in the Display tells you the number of the row you are going to knit next.

- You can either continue ... Repeat Steps 5 - 6 .
- Or finish pattern knitting ...

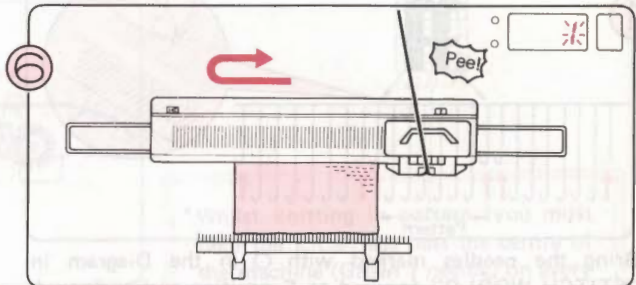

Knit in pattern until you hear the sound "Pee!". If you are operating the K-Carriage from right to left when you hear the sound, finish the row and knit one more row.

Number 1 flashes on and off in the Display. You have now knitted one complete pattern in length.

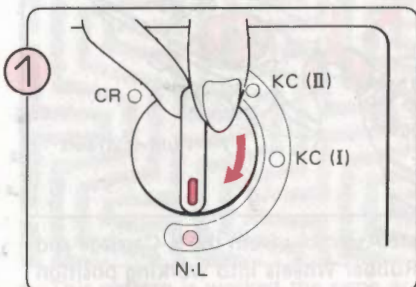

Set the Change Knob to N-L. The Cam Buttons will be released automatically.

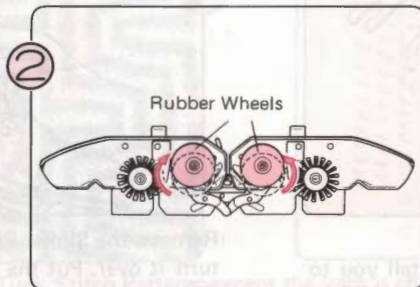

Place the Rubber Wheels in non-working position.

Whilst knitting in pattern, you must take the K-Carriage past the centre of the machine (Green 1 needle) on every row.

## OPEN TUCK STITCH PATTERN

- This example was knitted using "STITCH WORLD" Pattern No. 292.



### Example: PATTERN PROGRAM

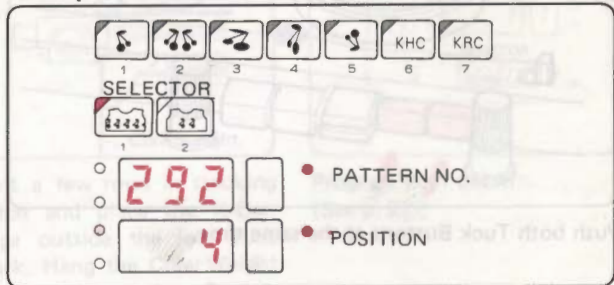

### • BEFORE STARTING PATTERN KNITTING

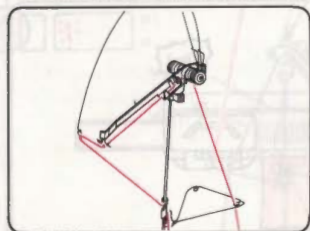

Thread main Yarn into the righthand Yarn Tension Unit.

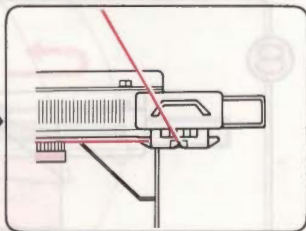

Cast on.

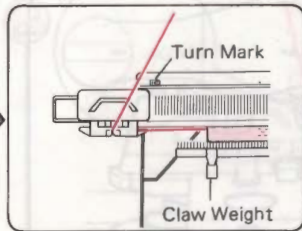

Knit a few rows in stocking stitch and place the K-Carriage outside the left Turn Mark. Hang the Claw Weight evenly along the Cast-on Comb.

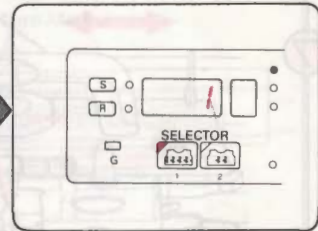

Program your pattern. (See p. 23.)

# TUCK STITCH PATTERN

## • PATTERN KNITTING

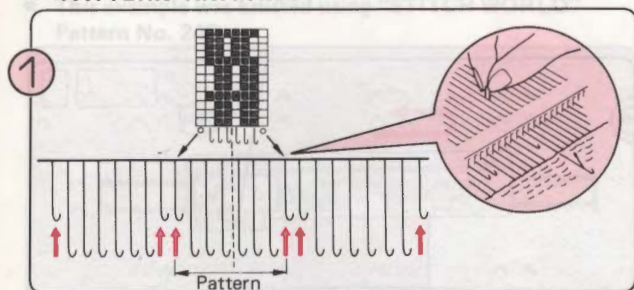

Bring the needles marked with ○ in the Diagram in "STITCH WORLD" forward to E position and back to A position.

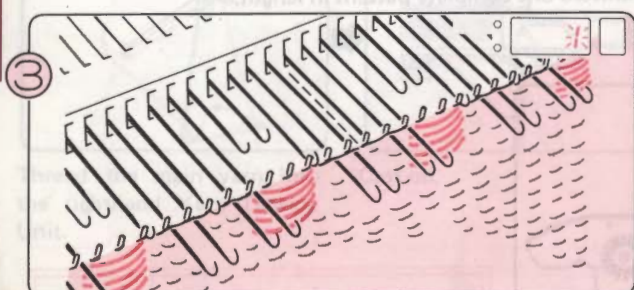

The needles are selected. Number 1 flashes on and off in the Display to tell you to knit the first row of the pattern.

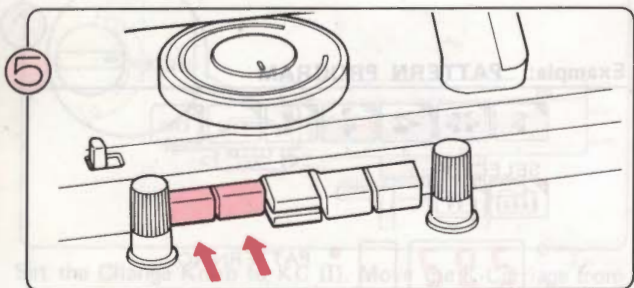

Push both Tuck Buttons at the same time.

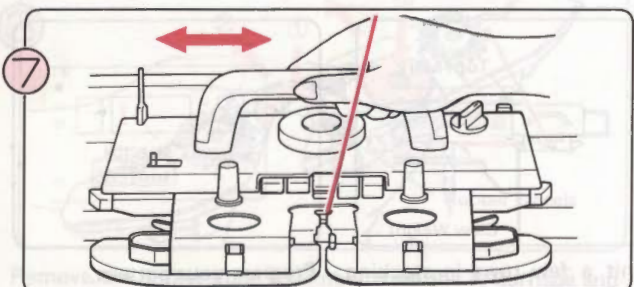

Move the K-Carriage back and forth. You are knitting in Open Tuck Stitch Pattern. (Don't forget the end needles must always be in D position). The number in the Display tells you the row you are going to knit next.

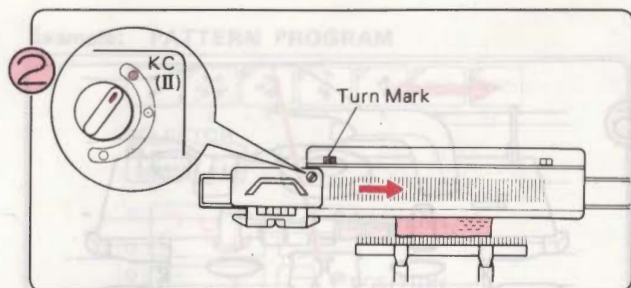

Set the Change Knob to KC (II).

Move the K-Carriage from left to right across the left Turn Mark.

\*You only need to operate the K-Carriage once across the Turn Mark when you start pattern knitting.

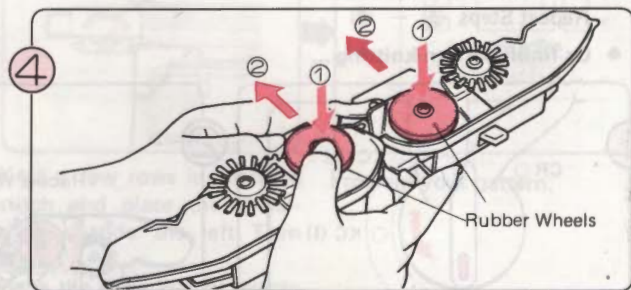

Remove the Sinker Plate Assembly from the K-Carriage and turn it over. Put the Rubber Wheels into working position ② as shown. Attach the Sinker Plate Assembly back on the K-Carriage again.

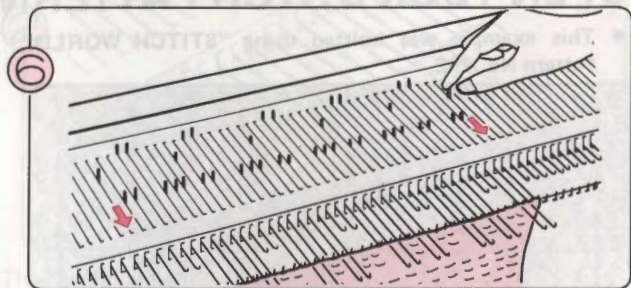

Bring the end needles forward to D position if they are not already in this position.

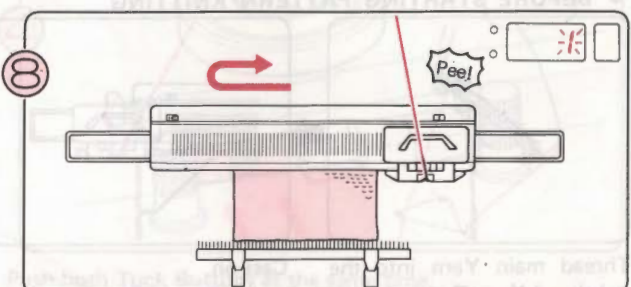

Knit in pattern until you hear the sound "Pee!". If you are operating the K-Carriage from right to left when you hear the sound, finish that row and knit one more row. The number 1 flashes on and off in the Display.

- You can either continue ...  
Repeat Steps ⑦ – ⑧ .
- Or finish pattern knitting ...

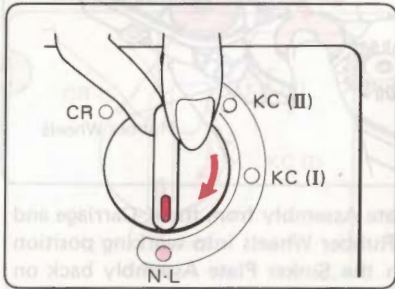

Set the Change Knob to N-L.  
The Cam Buttons will be automatically released.

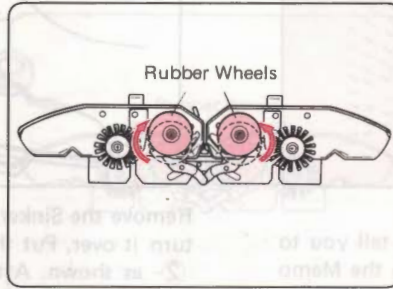

Place the Rubber Wheels in non-working position.

\*Whilst knitting in pattern, you must take the K-Carriage past the centre of the machine (Green 1 needle) on every row.

## MULTI-COLOUR TUCK STITCH PATTERN

- This example was knitted using "STITCH WORLD" Pattern No. 296.



- This pattern is worked the same as Tuck Stitch Pattern, except the yarn is changed according to the number in the Memo Display.

Pattern No. 296 requires yarn in two colours (colour 1 and colour 2) and these are represented by the numbers 1 and 2 in the Memo Display. So, to start, decide which yarn corresponds to which number.

### Example: PATTERN PROGRAM

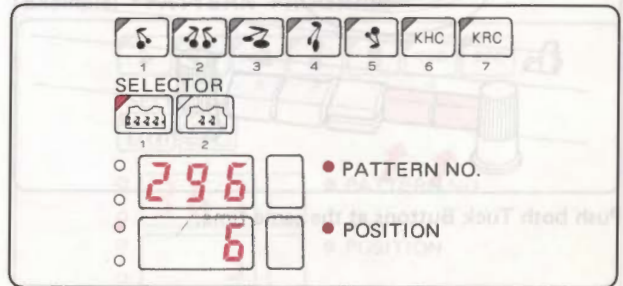

### BEFORE STARTING PATTERN KNITTING

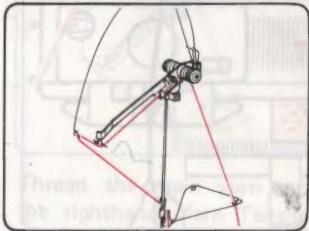

Thread the yarn 1 into the righthand Yarn Tension Unit.

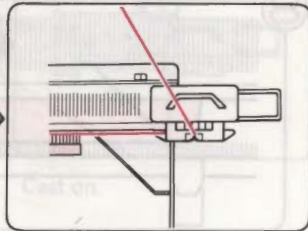

Cast on.

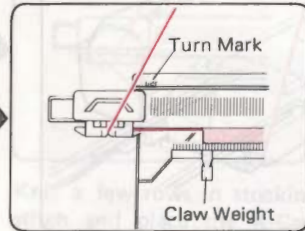

Knit a few rows in stocking stitch and place the K-Carriage outside the left Turn Mark. Hang the Claw Weight evenly along the Cast-on Comb.

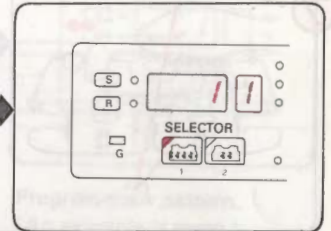

Program your pattern. (See p. 23.)

### PATTERN KNITTING

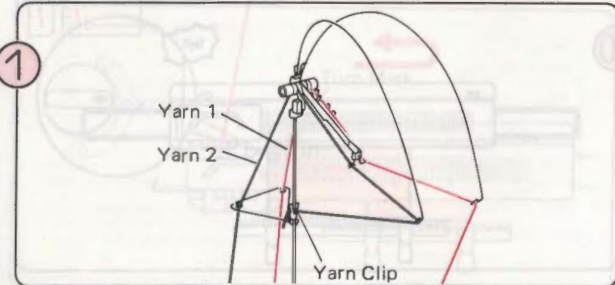

Thread Yarn 2 into the lefthand Yarn Tension Unit.

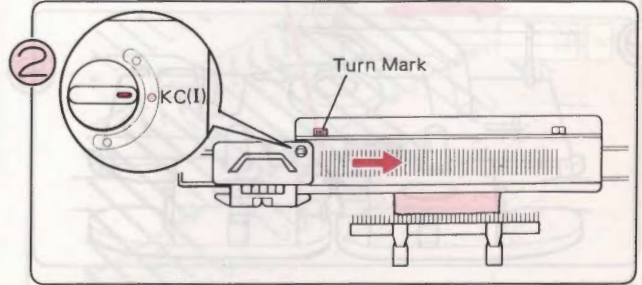

Set the Change Knob to KC (I).

Move the K-Carriage from left to right across the left Turn Mark.

\*You only need to operate the K-Carriage once across the Turn Mark when you start pattern knitting.

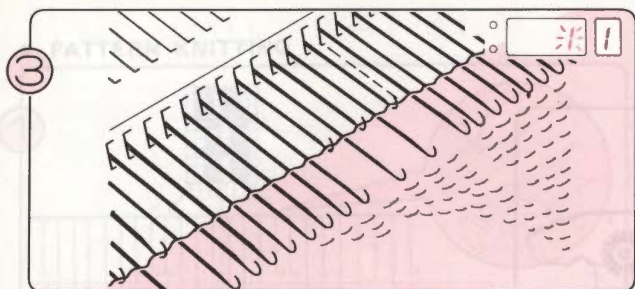

The needles are selected. Number 1 flashes on and off in the Display to tell you to knit the first row of the pattern. Number 1 in the Memo Display tells you to knit with Yarn 1.

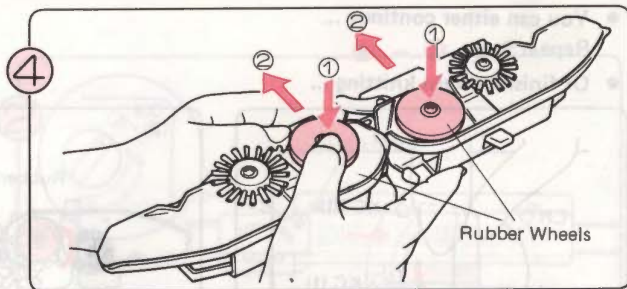

Remove the Sinker Plate Assembly from the K-Carriage and turn it over. Put the Rubber Wheels into working position ② as shown. Attach the Sinker Plate Assembly back on the K-Carriage again.

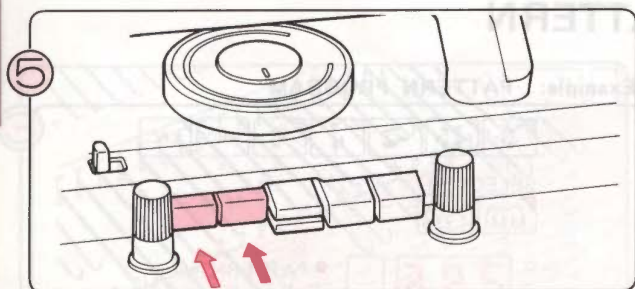

Push both Tuck Buttons at the same time.

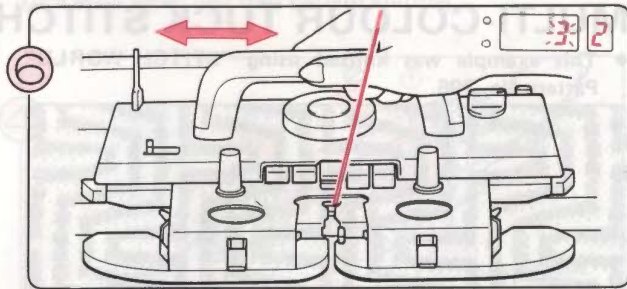

Move the K-Carriage back and forth until the number 2 appears in the Memo Display. Number 3 in the Display and Number 2 in the Memo Display tell you to knit the third row with Yarn 2.

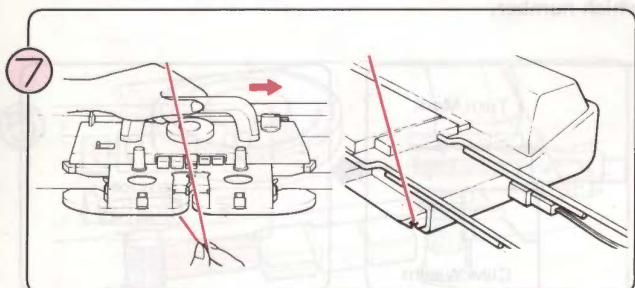

Take Yarn 1 out of Yarn Feeder "A". If you slide the K-Carriage slightly to the right the yarn can be removed easily. Hook Yarn 1 around the notch at the end of your machine.

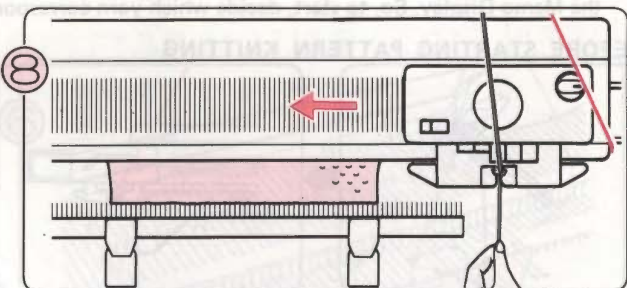

Thread Yarn 2 into Yarn Feeder "A" and continue knitting until Number 1 appears in the Memo Display.

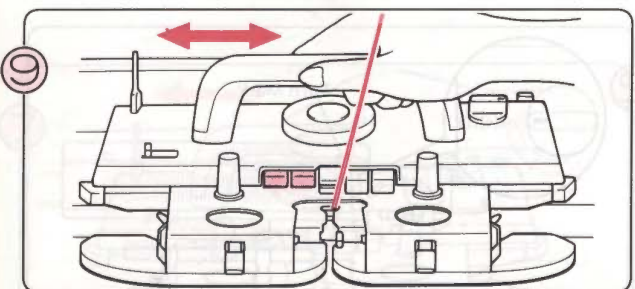

Continue knitting, changing the yarns according to the number in the Memo Display. (When you change the yarns, take care not to cross them over each other.)

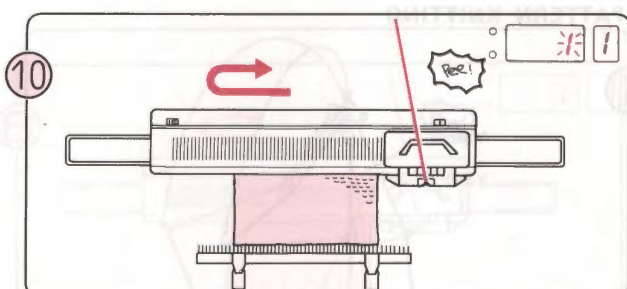

Knit in pattern until you hear the sound "Pee!". If you are operating the K-Carriage from right to left when you hear the sound, finish the row and knit one more row. Number 1 flashes on and off in the Display. You have now knitted one complete pattern in length.

- You can either continue ...  
Repeat Steps ⑨ - ⑩ .
- Or finish pattern knitting ...

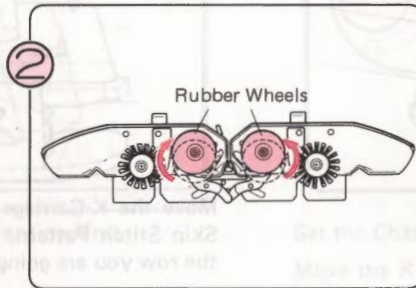
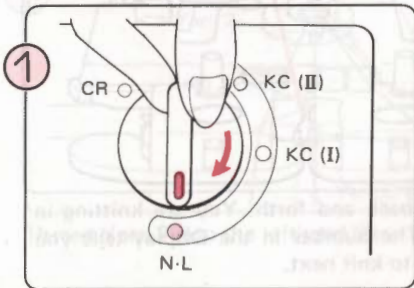

Whilst knitting in pattern, you must take the K-Carriage past the centre of the machine (Green 1 needle) on every row.

Set the Change Knob to N-L.  
The Cam Buttons will be released automatically.

Place the Rubber Wheels in non-working position.

## SKIP STITCH PATTERN

- This example was knitted using "STITCH WORLD" Pattern No. 363.



### Example: PATTERN PROGRAM

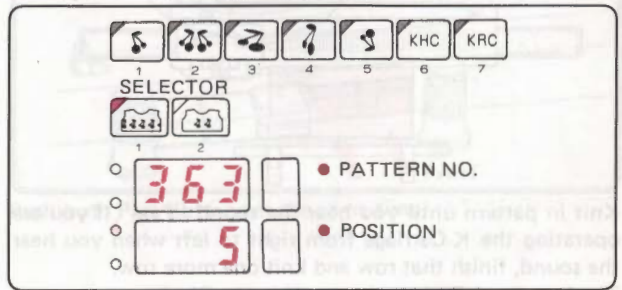

### • BEFORE STARTING PATTERN KNITTING

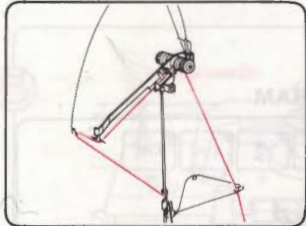

Thread the main yarn into the righthand Yarn Tension Unit.

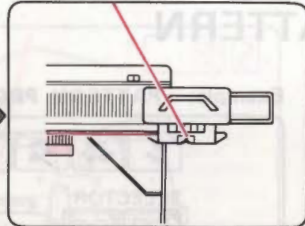

Cast on.

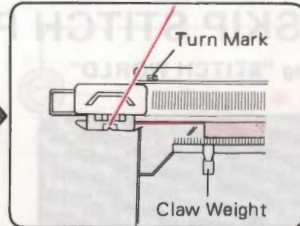

Knit a few rows in stocking stitch and place the K-Carriage outside the left Turn Mark. Hang the Claw Weight evenly along the Cast-on Comb.

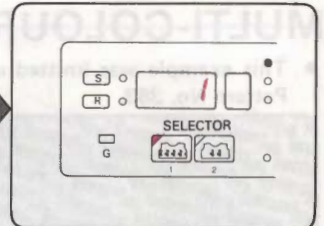

Program your pattern.  
(An example is given.)  
(See p. 23.)

### • PATTERN KNITTING

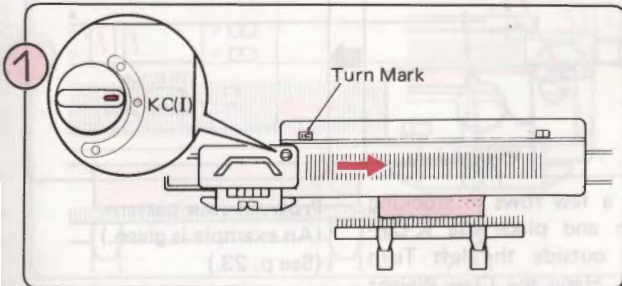

Set the Change Knob to KC (II).

Move the K-Carriage from left to right across the left Turn Mark.

\*You only need to operate the K-Carriage once across the Turn Mark when you start pattern knitting.

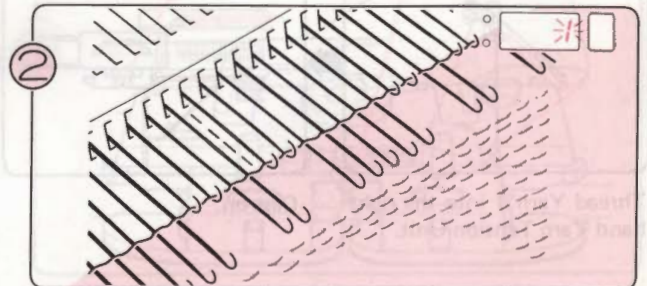

The needles are selected.

Number 1 flashes on and off in the Display to tell you to knit the first row of the pattern.

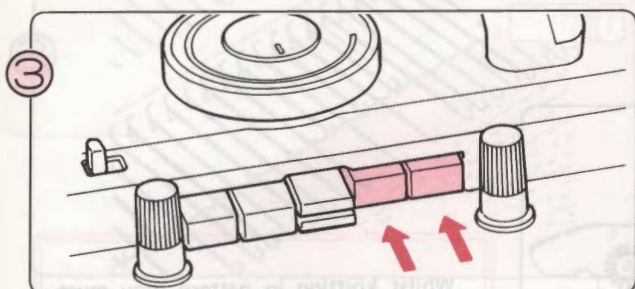

3 Push both Part Buttons at the same time.

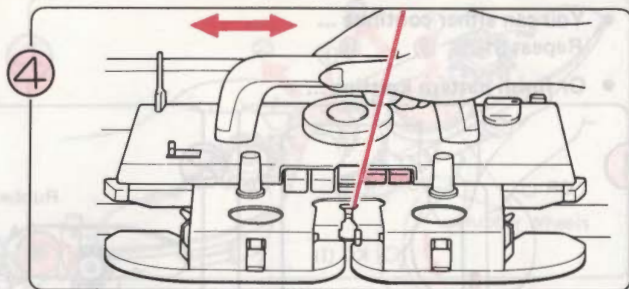

4 Move the K-Carriage back and forth. You are knitting in Skip Stitch Pattern. The number in the Display tells you the row you are going to knit next.

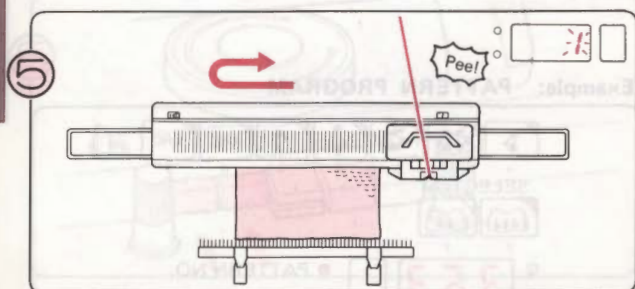

5 Knit in pattern until you hear the sound "Peel". If you are operating the K-Carriage from right to left when you hear the sound, finish that row and knit one more row. The Number 1 flashes on and off in the Display.

• You can either continue:  
Repeat Steps 4 - 5.

• Or finish pattern knitting ...

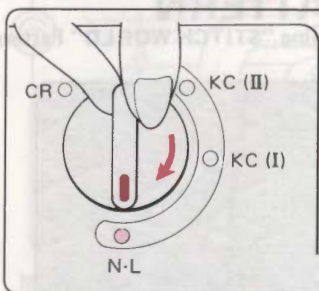

Set the Change Knob to N-L. The Cam Buttons will be automatically released.

Whilst knitting in pattern, you must take the K-Carriage past the centre of the machine (Green 1 needle) on every row.

## MULTI-COLOUR SKIP STITCH PATTERN

• This example was knitted using "STITCH WORLD" Pattern No. 383.



• BEFORE STARTING PATTERN KNITTING

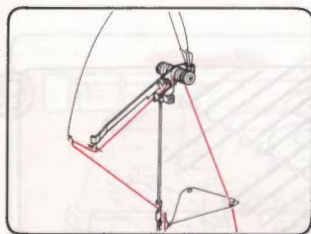

Thread Yarn 1 into the right-hand Yarn Tension Unit.

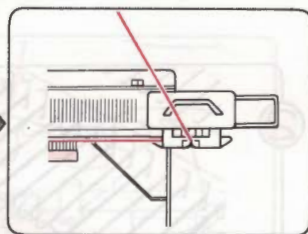

Cast on.

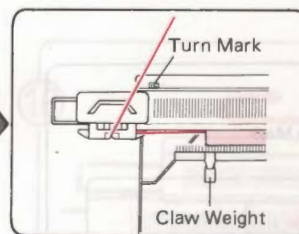

Knit a few rows in stocking stitch and place the K-Carriage outside the left Turn Mark. Hang the Claw Weight evenly along the Cast-on comb.

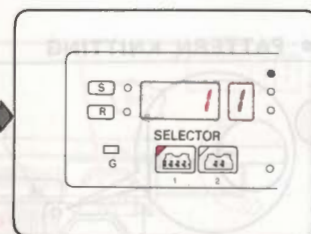

Program your pattern. (An example is given.) (See p. 23.)

Example: PATTERN PROGRAM

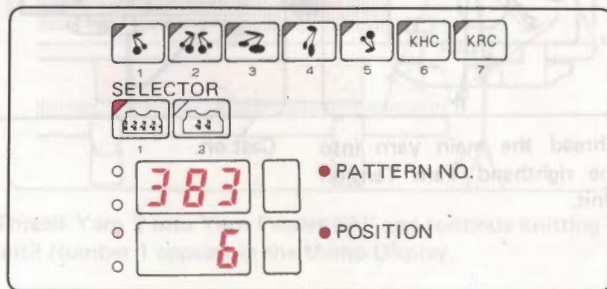

This pattern is worked the same as Skip Stitch Pattern, except the yarn is changed according to the numbers in the Memo Display. Pattern No. 383 requires yarn in two colours (colour 1 and colour 2) and these are represented by the Number 1 and 2 in the Memo Display. So, to start, decide which yarn corresponds to which number.

**• PATTERN KNITTING**

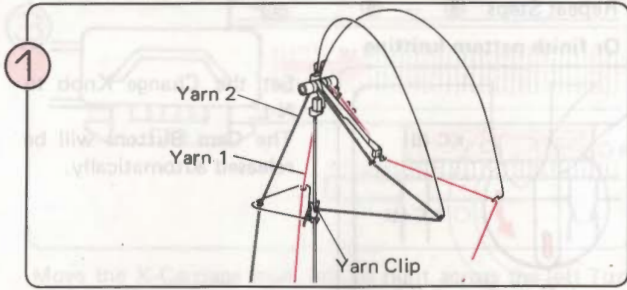

Thread Yarn 2 into the lefthand Yarn Tension Unit.

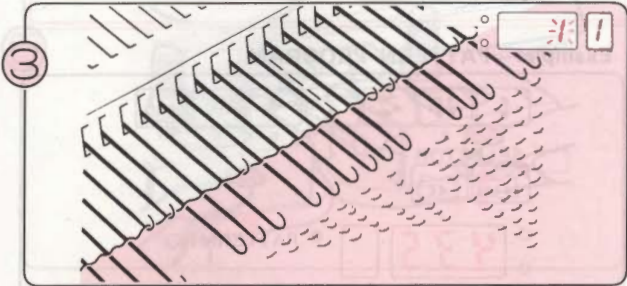

The needles are selected. Number 1 flashes on and off in the Display to tell you to knit the first row of the pattern. Number 1 in the Memo Display tells you to knit with Yarn 1.

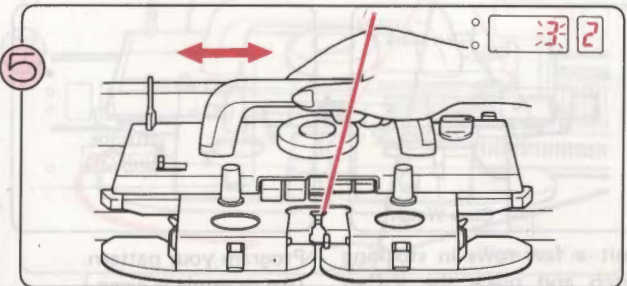

Move the K-Carriage back and forth until the Number 2 appears in the Memo Display. Number 3 in the Display and Number 2 in the Memo Display tell you to knit the third row with Yarn 2.

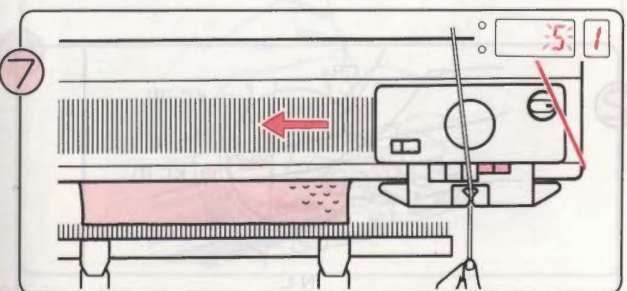

Thread Yarn 2 into Yarn Feeder "A" and continue knitting until Number 1 appears in the Memo Display.

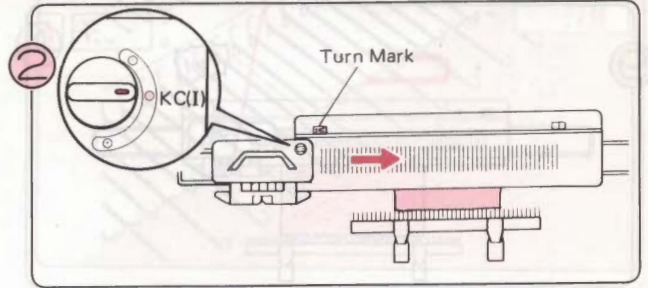

Set the Change Knob to KC (I).

Move the K-Carriage from left to right across the left Turn Mark.

\*You only need to operate the K-Carriage once across the Turn Mark when you start pattern knitting.

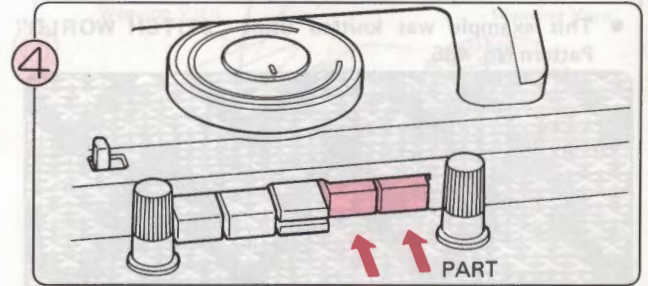

Push both Part Buttons at the same time.

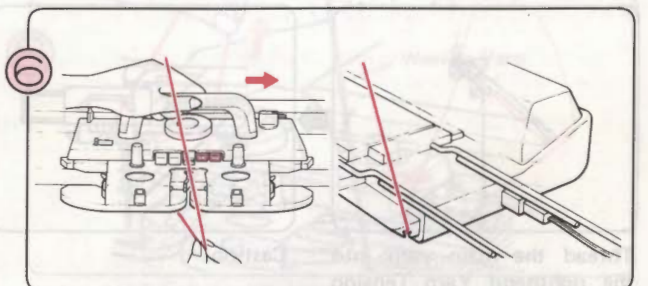

Take Yarn 1 out of Yarn Feeder "A". If you slide the K-Carriage slightly to the right the yarn can be removed easily. Hook Yarn 1 around the notch at the end of your machine.

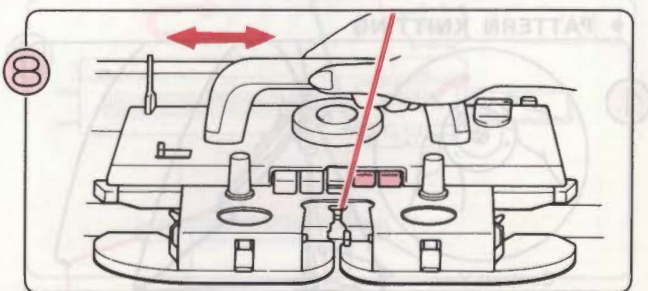

Continue knitting, changing the yarns according to the number in the Memo Display. (When you change the yarns, take care not to cross them over each other.)



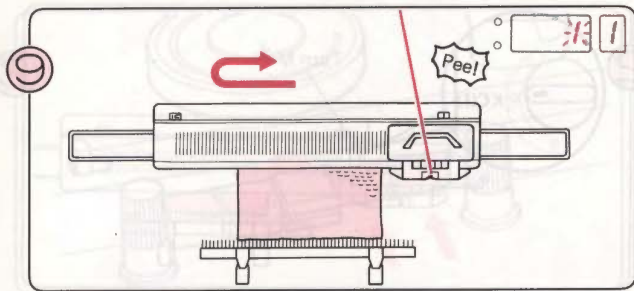

Knit in pattern until you hear the sound "Peel". If you are operating the K-Carriage from right to left when you hear the sound, finish the row and knit one more row. Number 1 flashes on and off in the Display. You have now knitted one complete pattern in length.

## WEAVING PATTERN

- This example was knitted using "STITCH WORLD" Pattern No. 435.

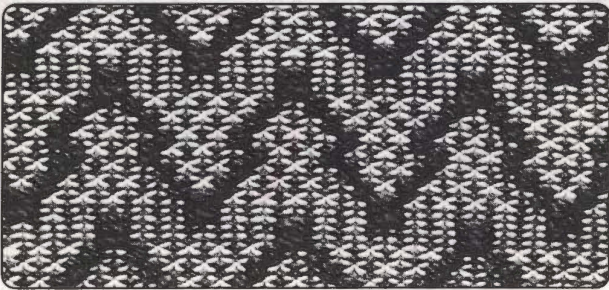

- You can either continue ... Repeat Steps 8 - 9
- Or finish pattern knitting ...

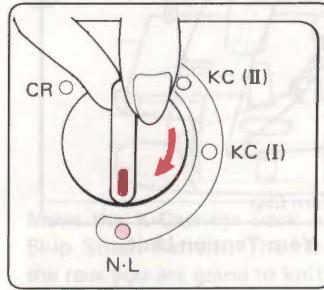

Set the Change Knob to N-L. The Cam Buttons will be released automatically.

Whilst knitting in pattern, you must take the K-Carriage past the centre of the machine (Green 1 needle) on every row.

### Example: PATTERN PROGRAM

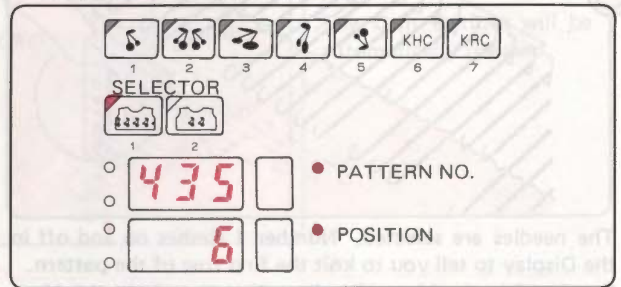

### BEFORE STARTING PATTERN KNITTING

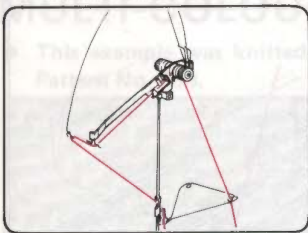

Thread the main yarn into the righthand Yarn Tension Unit.

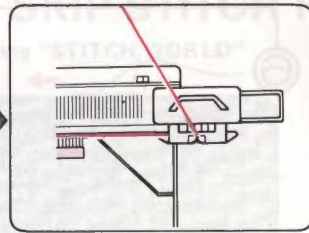

Cast on.

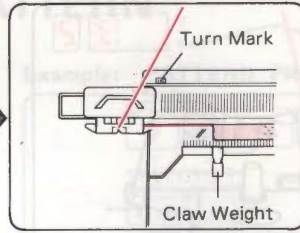

Knit a few rows in stocking stitch and place the K-Carriage outside the left Turn Mark. Hang the Claw Weight evenly along the Cast-on Comb.

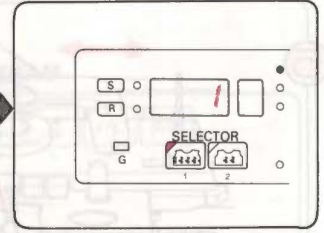

Program your pattern. (An example is given.) (See p. 23.)

Pattern No. 435 requires two types of yarn – the main yarn and the weaving yarn. A better effect will result if you choose a weaving yarn that is thicker than the main yarn.

### • PATTERN KNITTING

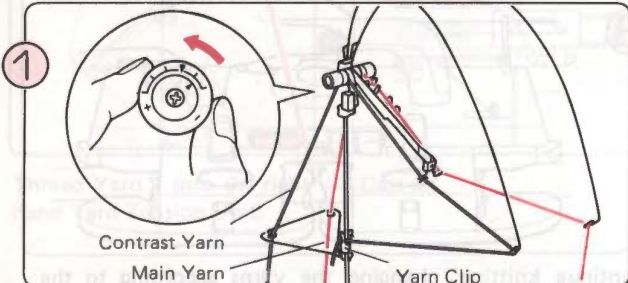

Thread the weaving yarn into the left Yarn Tension Unit. Adjust the Tension Disc as shown according to the thickness of the weaving yarn.

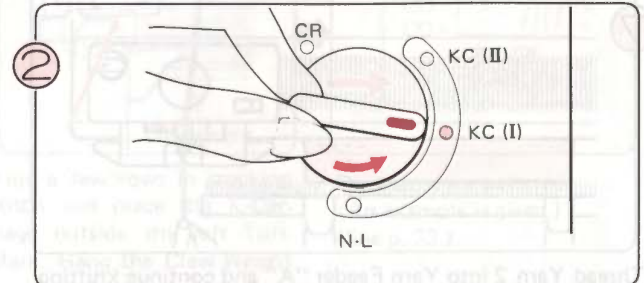

Set the Change Knob to KC (I).

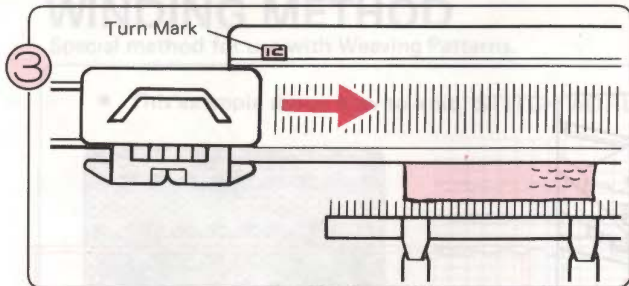

Move the K-Carriage from left to right across the left Turn Mark.

\*You only need to operate the K-Carriage once across the Turn Mark when you start pattern knitting.

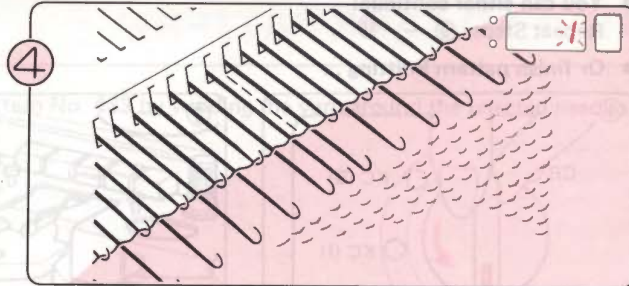

The needles are selected.

Number 1 flashes on and off in the Display to tell you to knit the first row of the pattern.

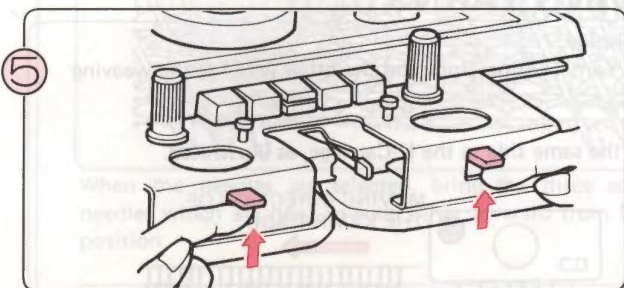

Set the Weaving Pattern Levers to W.T.

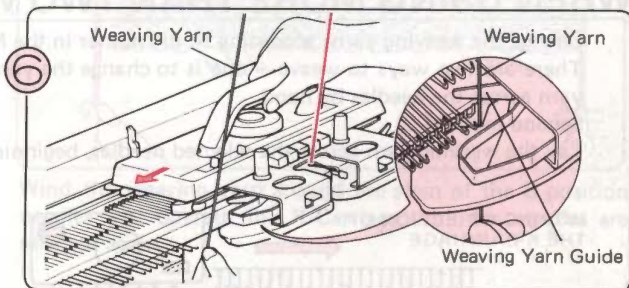

Hold the end of the weaving yarn with your left hand, and thread it into the Weaving Yarn Guide on the left side of the K-Carriage. Then move the K-Carriage across the needle-bed.

\* Release the yarn end after knitting one row.

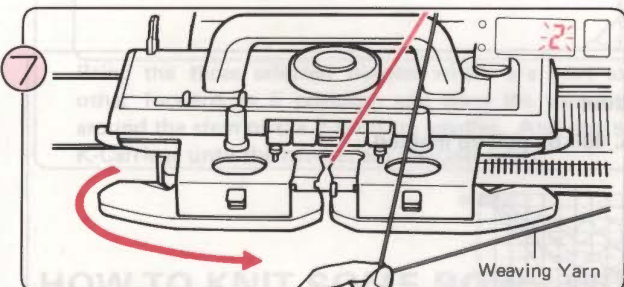

Remove the weaving yarn from the left Weaving Yarn Guide by moving the K-Carriage slightly to the left. Pass the weaving yarn under the K-Carriage to the righthand side.

Number 2 in the Display tells you to knit the second row of the pattern.

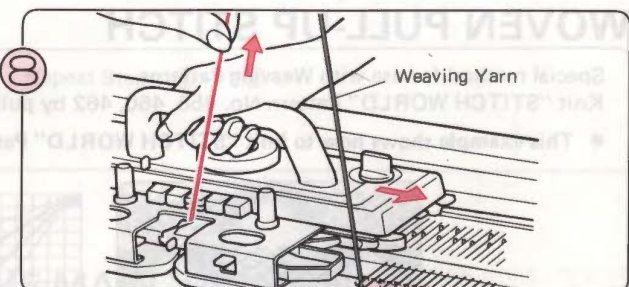

Move the K-Carriage to the right, pulling the main yarn upwards slightly – ensure that the weaving yarn is in the right Weaving Yarn Guide.

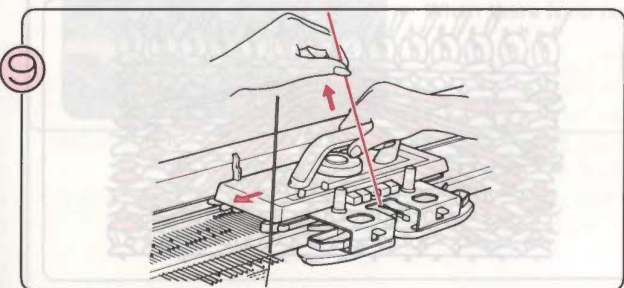

Continue knitting at the same time placing the weaving yarn into the left or right Weaving Yarn Guide according to the direction of the K-Carriage, and pulling the main yarn upwards slightly.

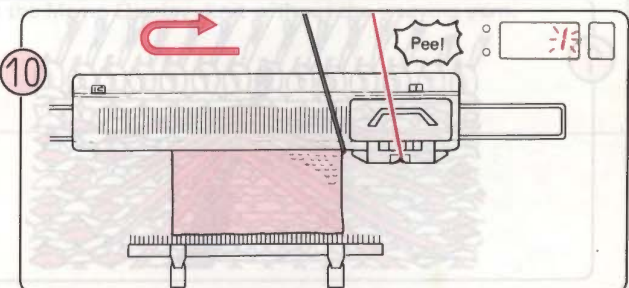

Knit in pattern until you hear the sound "Peel". If you are operating the K-Carriage from right to left when you hear the sound, finish that row and knit one more row. The Number 1 flashes on and off in the Display.

- You can either continue:  
Repeat Steps 9 – 10.
- Or finish pattern knitting ...

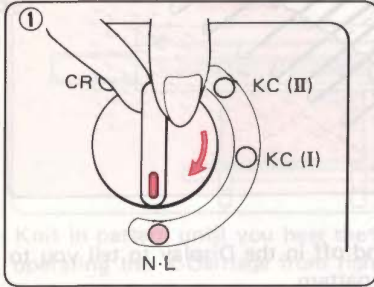

Set the Change Knob to N-L.

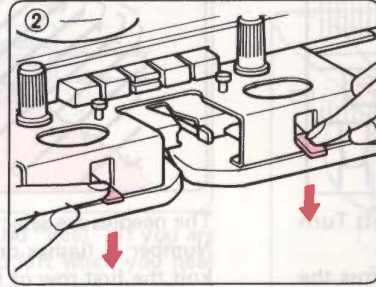

Set the Weaving Pattern Levers to N.

Whilst knitting in pattern, you must take the K-Carriage past the centre of the machine (Green 1 needle) on every row.

## WHEN USING MORE THAN TWO WEAVING YARNS ...

Change the weaving yarns according to the number in the Memo Display.

There are two ways to weave – one is to change the yarn in the Yarn Tension Unit, and the other is to lay the weaving yarn across the needles by hand.

**Second method ...**

Lay the weaving yarn across the selected needles, beginning from the same side as the K-Carriage, as illustrated.

MOVING DIRECTION OF THE K-CARRIAGE

Hold the weaving yarn lightly.

Add some weight to the end of the yarn.

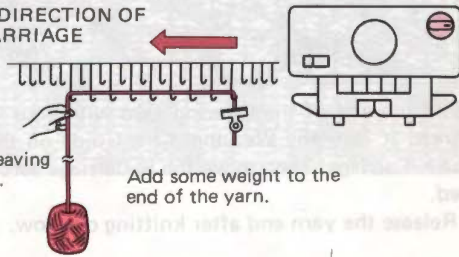

MOVING DIRECTION OF THE K-CARRIAGE

Weaving yarn

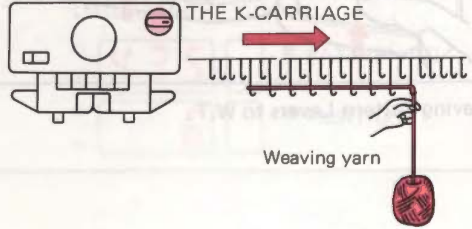

## WOVEN PULL-UP STITCH

Special method for use with Weaving Patterns.

Knit "STITCH WORLD" Pattern No. 458, 460, 462 by pull-up method.

- This example shows how to knit "STITCH WORLD" Pattern No. 460 by pull-up method.

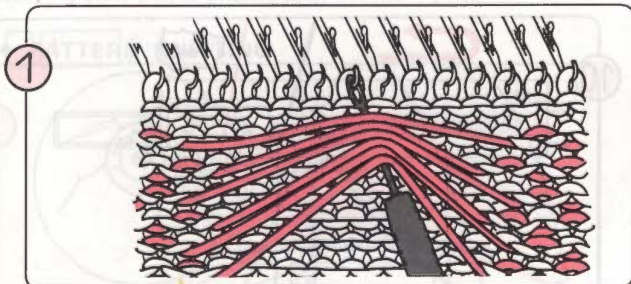
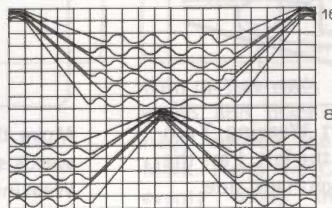
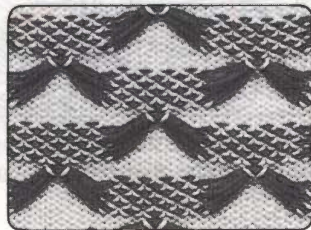

Knit until the number indicated at the right side of the diagram in "STITCH WORLD" appears in the Display.

Using your Transfer Tool, pick up the long weaving yarns which lie across the front of the stitches, and place them onto the needle shown. This is illustrated above.

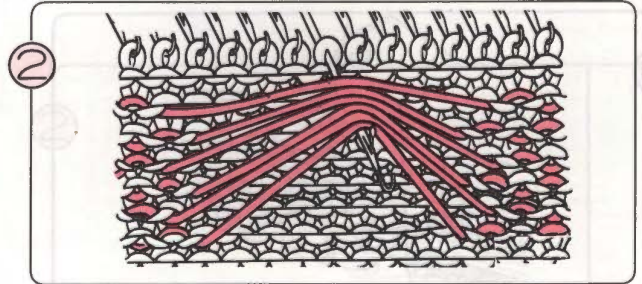

Now bring these needles forward to E position and continue knitting.

# WINDING METHOD

Special method for use with Weaving Patterns.

- This example shows how to knit "STITCH WORLD" Pattern No. 463 by winding the yarn around the selected needles.

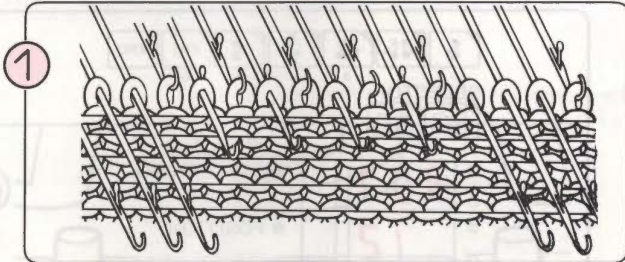
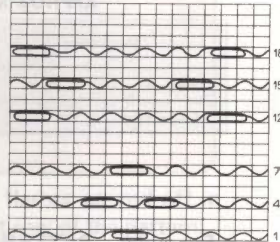
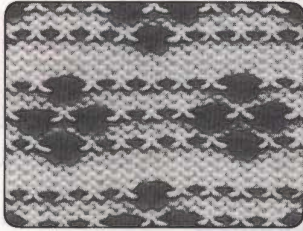

When the needles are selected, bring the three selected needles which are next to each other forward from D to E position.

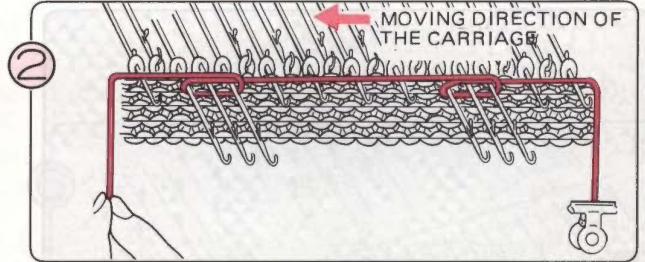

Wind the weaving yarn around the stem of the E position needles and operate the K-Carriage until the needles are selected again.

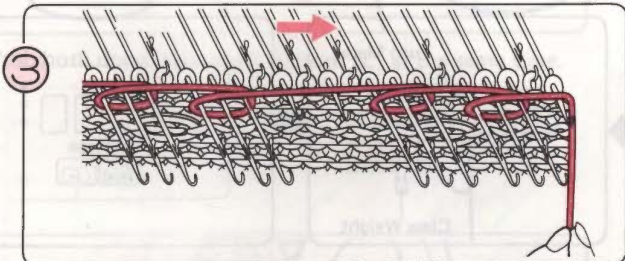

Bring the three selected needles which are next to each other forward to E position, and wind the weaving yarn around the stem of the E position needles. And operate the K-Carriage until the needles are selected again.



Repeat Steps ① - ③ .

# HOW TO KNIT SOME ROWS WITH THE MAIN YARN ONLY.

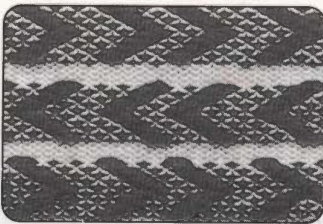

- This example was knitted using "STITCH WORLD" Pattern No. 439.

When the number appears in the Memo Display, you should knit using the weaving yarn.

When there is no number in the Memo Display, knit without the weaving yarn.

# THREAD LACE PATTERN

## SELECTOR 1

You can obtain this pattern by using a combination of medium yarn and very fine yarn.

Use medium (or fine) yarn as the main yarn, and very fine yarn in a similar colour to the main yarn, for the contrast.

- This example was knitted using "STTICH WORLD" Pattern No. 397.



APPROXIMATE TENSION CHART

MAIN YARN	CONTRAST YARN	DIAL
Fine Yarn	Very fine yarn	4-9
Medium Yarn	Very fine yarn	6-9

Example: PATTERN PROGRAM

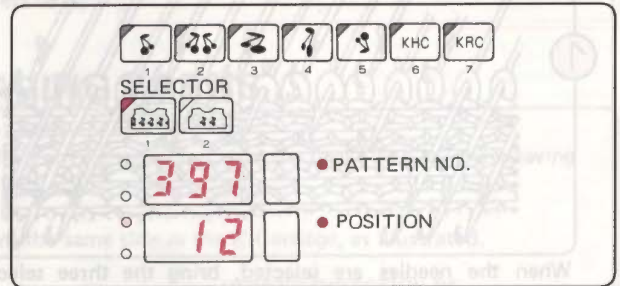

- BEFORE STARTING PATTERN KNITTING

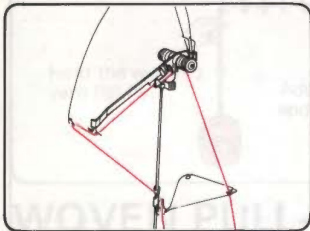

Thread the main yarn into the righthand Yarn Tension Unit.

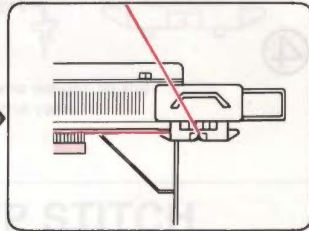

Cast on.

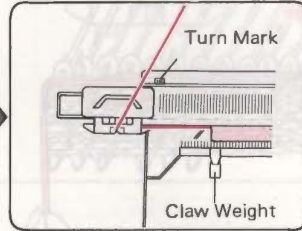

Knit a few rows in stocking stitch and place the K-Carriage outside the left Turn Mark. Hang the Claw Weight evenly along the Cast-on Comb.

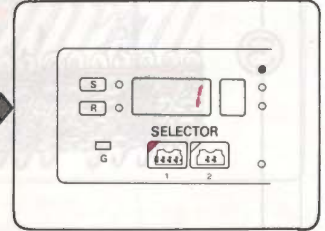

Program your pattern. (An example is given). (See p. 23.)

- PATTERN KNITTING

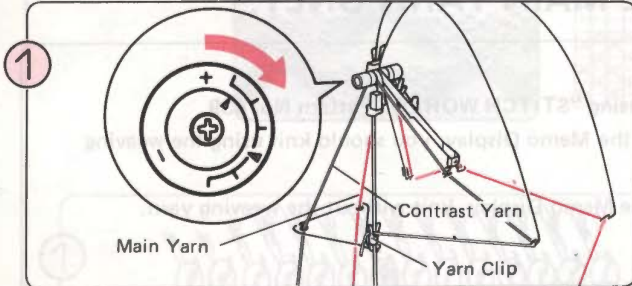

Thread the very fine contrast yarn into the lefthand Yarn Tension Unit.

Thread the main yarn into the Sub Take-up Spring.

\* Turn the Tension Disc (both right and left) to right.

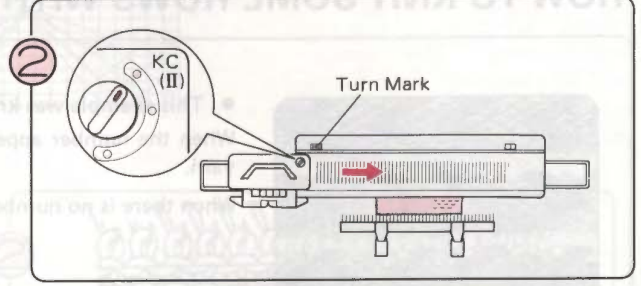

Set the Change Knob to KC (II).

Move the K-Carriage from left to right across the left Turn Mark.

\*You only need to operate the K-Carriage once across the Turn Mark when you start pattern knitting.

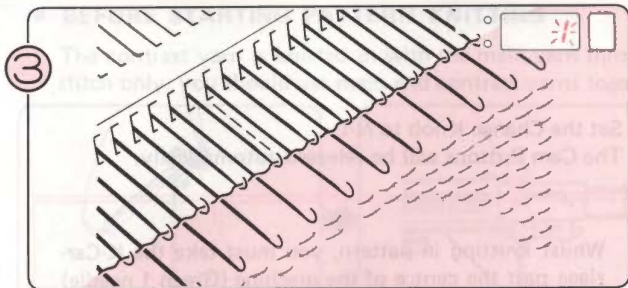

③ The needles are selected. Number 1 flashes on and off in the Display to tell you to knit the first row of the pattern.

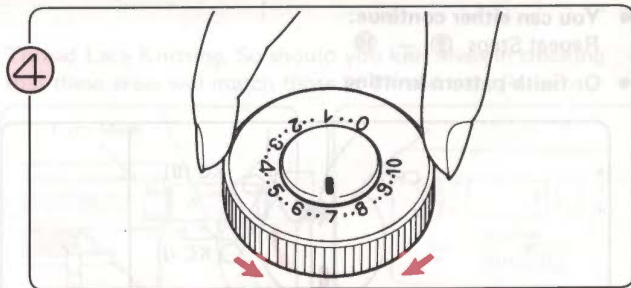

④ Set the Tension Dial using the Tension Chart on page 95 as a guide.

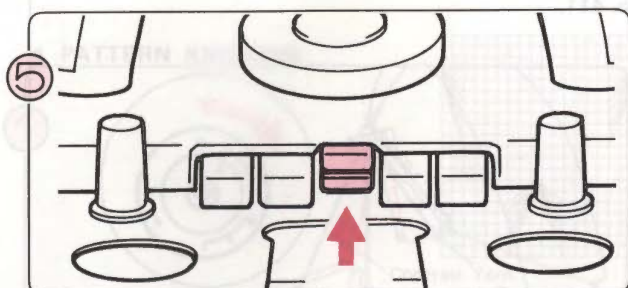

⑤ Push both upper and lower buttons (L) at the same time.

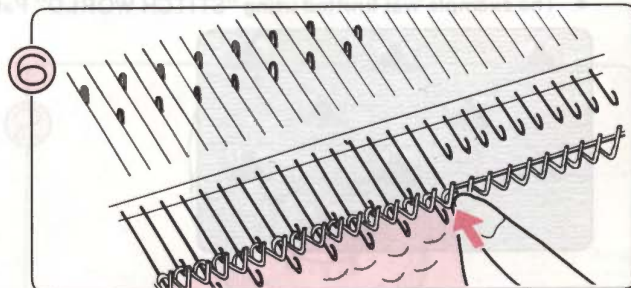

⑥ If an end needle is in D position, bring it back to B position.

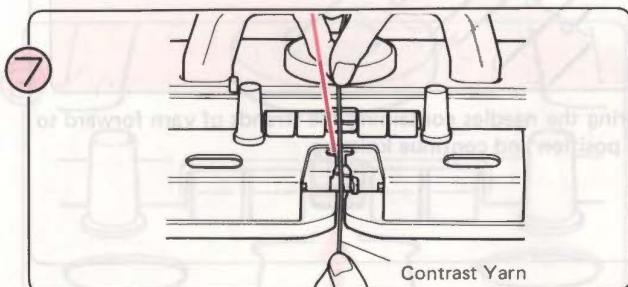

⑦ Thread the contrast yarn into Yarn Feeder "B" – there is no need to open the Yarn Feeder Lever when you do so.

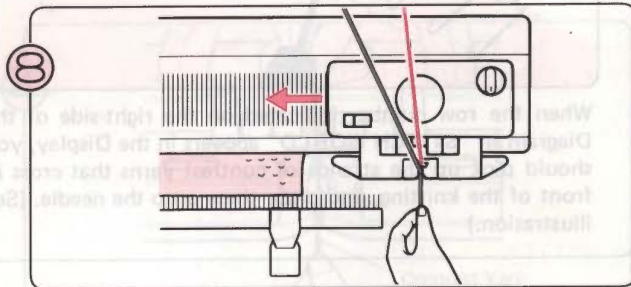

⑧ Knit a row with the K-Carriage, at the same time holding the yarn end with your left hand.

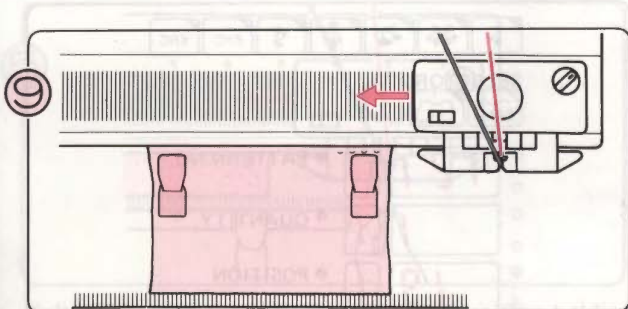

⑨ Continue knitting, remembering to bring the selected end needle back to B position (See Step ⑥).

\* Move the K-Carriage slowly.

\* Rehang the Claw Weights every 20 rows or so.

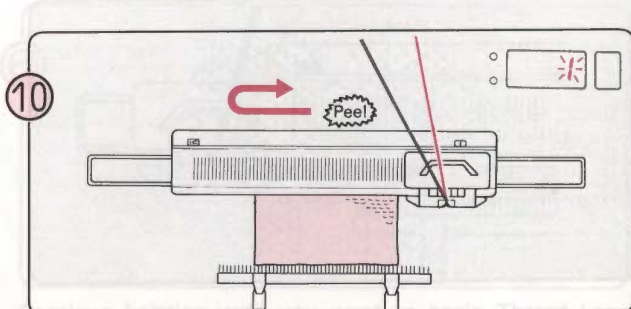

⑩ Knit in pattern until you hear the sound "Peel". If you are operating the K-Carriage from right to left when you hear the sound, finish the row and knit one more row. Number 1 flashes on and off in the Display. You have now knitted one complete pattern in length.

- You can either continue:  
Repeat Steps 9 - 10.
- Or finish pattern knitting ...

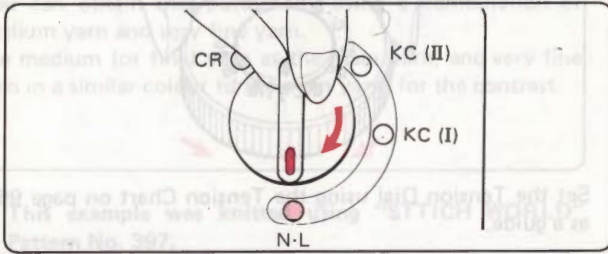

Set the Change Knob to N-L.  
The Cam Buttons will be released automatically.

Whilst knitting in pattern, you must take the K-Carriage past the centre of the machine (Green 1 needle) on every row.

## PULL-UP PATTERN

Knit "STITCH WORLD" Pattern No. 408, 409, 410, 411 and 412 by pulling up the contrast yarn.

- The example was knitted using "STITCH WORLD" Pattern No. 411.

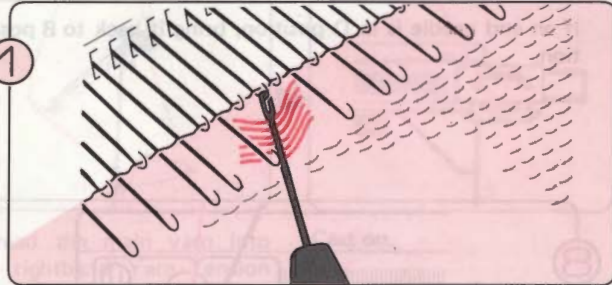
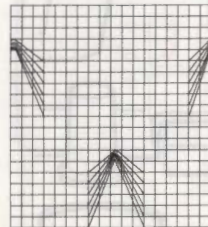
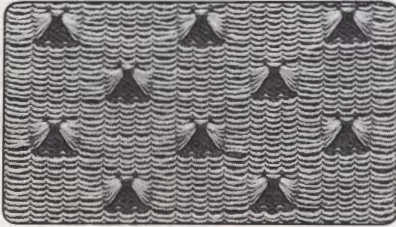

When the row number indicated on the right-side of the Diagram in "STITCH WORLD" appears in the Display, you should pick up the strands of contrast yarns that cross in front of the knitting, and place these onto the needle. (See illustration.)

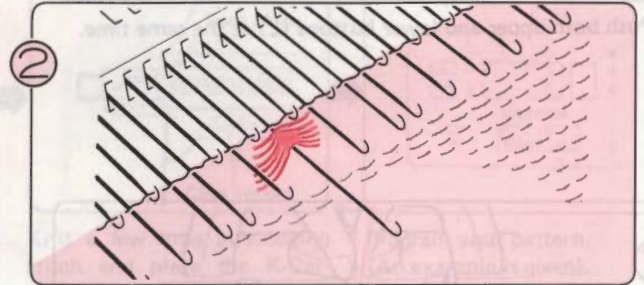

Bring the needles containing the strands of yarn forward to E position and continue knitting.

## SELECTOR 2

- This example was knitted using "STITCH WORLD" Pattern No. 421.



Example: PATTERN PROGRAM

1	2	3	4	5	6	7
					KHC	KRC
SELECTOR						
1	2					
○	4	2	1			● PATTERN NO.
○		1	1			● QUANTITY
○		1	9	1		● POSITION
○			0	2		● QUANTITY

• **BEFORE STARTING PATTERN KNITTING**

The contrast yarn is knitted in with the main yarn throughout Thread Lace Knitting. So should you knit areas in stocking stitch only, you should use main and contrast yarns together so that these areas will match those in Thread Lace Pattern.

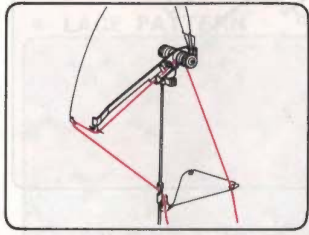

Thread the main yarn into the righthand Yarn Tension Unit.

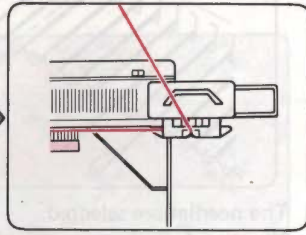

Cast on.

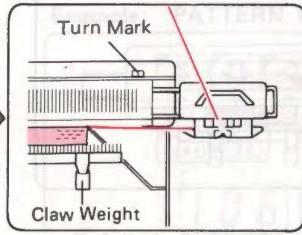

Knit a few rows in stocking stitch. Hang the Claw Weight evenly along the Cast-on Comb.

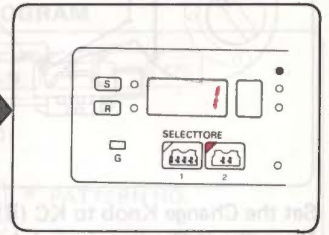

Program your pattern. (An example is given). (See p. 30.)

• **PATTERN KNITTING**

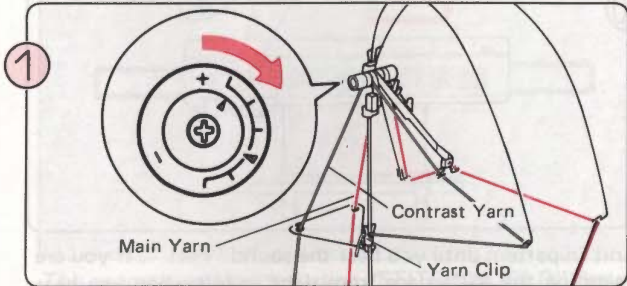

Thread the very fine contrast yarn into the lefthand Yarn Tension Unit. Thread the main yarn into the Sub Take-up Spring. \* Turn the Tension Disc (both right and left) to right.

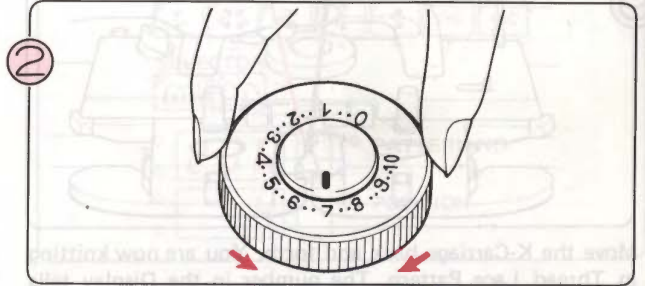

Set the Tension Dial using the Tension Chart on page 95 as a guide.

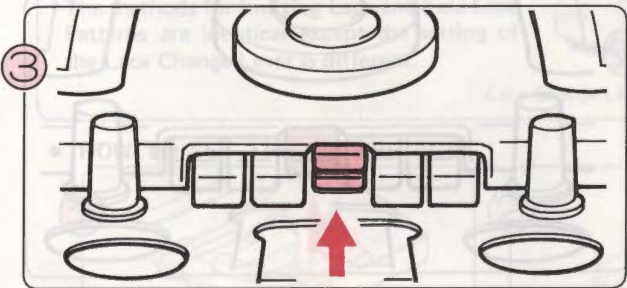

Push both upper and lower buttons (L) at the same time.

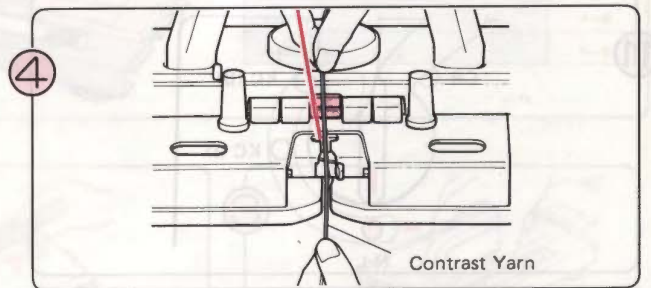

Thread the contrast yarn into Yarn Feeder "B" — there is no need to open the Yarn Feeder Lever when you do so.

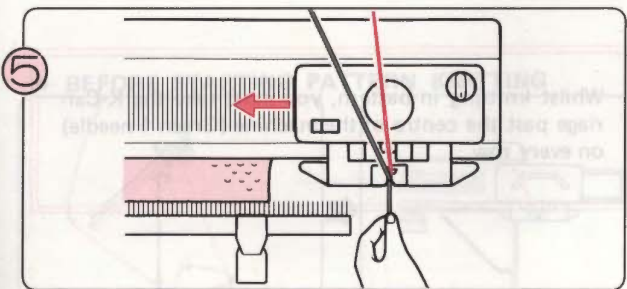

Knit a row with the K-Carriage, at the same time holding the yarn end with your lefthand.

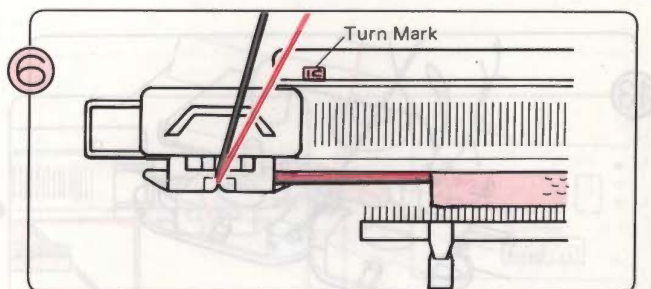

Continue knitting until you want to begin Thread Lace Knitting. Place the K-Carriage outside the left Turn Mark.



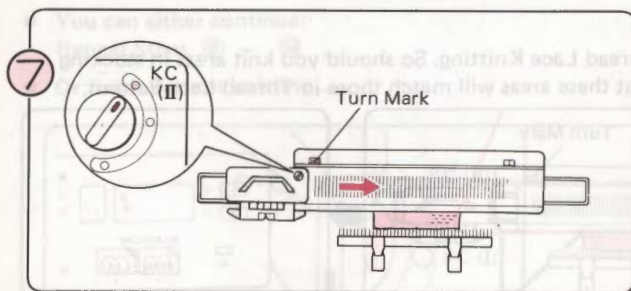

7 Set the Change Knob to KC (II).  
Move the K-Carriage from left to right across the left Turn Mark.  
\* You only need to operate the K-Carriage once across the Turn Mark when you start pattern knitting.

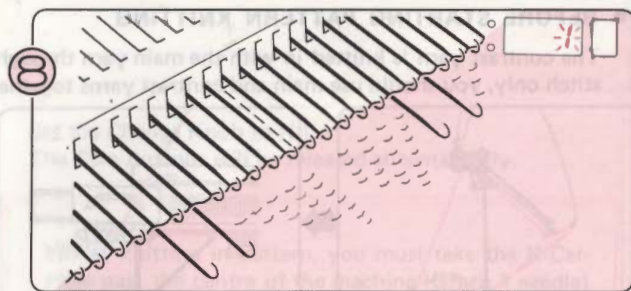

8 The needles are selected.  
Number 1 flashes on and off in the Display to tell you to knit the first row of the pattern.

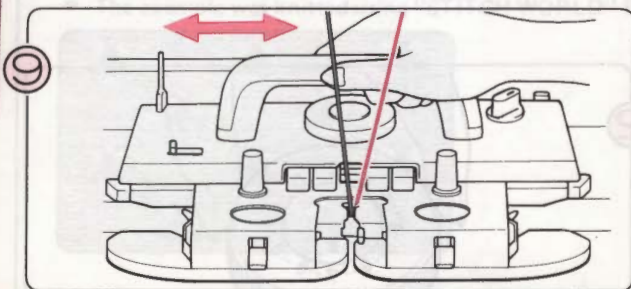

9 Move the K-Carriage back and forth. You are now knitting in Thread Lace Pattern. The number in the Display tells you the row you are going to knit next.

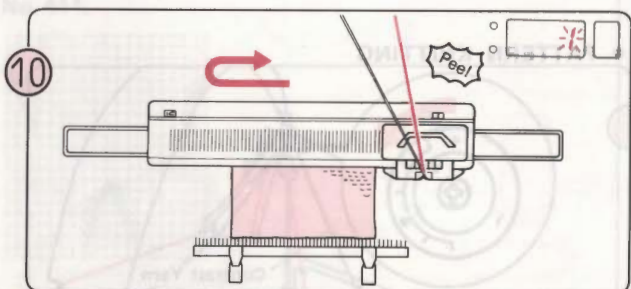

10 Knit in pattern until you hear the sound "Peel ". If you are operating the K-Carriage from right to left when you hear the sound, finish the row and knit one more row.  
Number 1 flashes on and off in the Display.

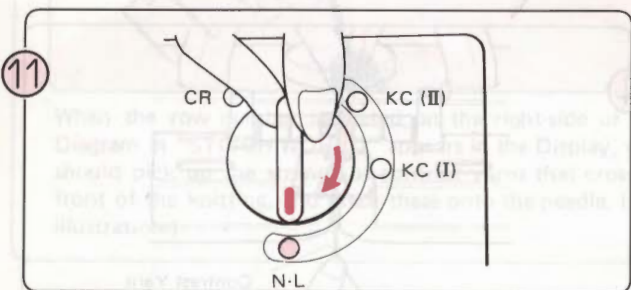

11 Set the Change Knob to N-L.  
The Cam Buttons will be released automatically.

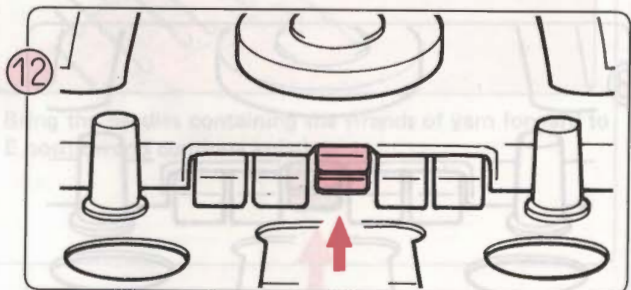

12 Push both upper and lower buttons (L) at the same time, and bring back the selected needles to B position. Then continue knitting until you want to finish.

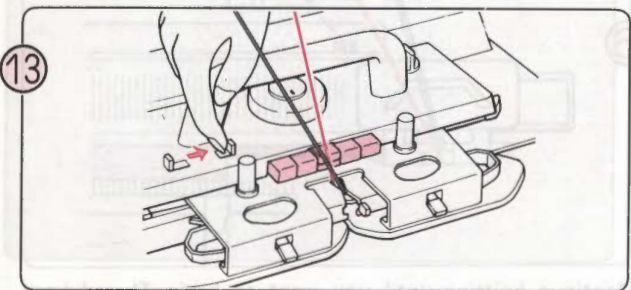

13 Slide the Cam Button Release Lever to the right to release the Cam Buttons.

Whilst knitting in pattern, you must take the K-Carriage past the centre of the machine (Green 1 needle) on every row.

# LACE PATTERN AND FINE LACE PATTERN

## SELECTOR 1

### • LACE PATTERN



This example was knitted using "STITCH WORLD" Pattern No. 106.

### • FINE LACE PATTERN



This example was knitted using "STITCH WORLD" Pattern No. 206.

### Example: PATTERN PROGRAM

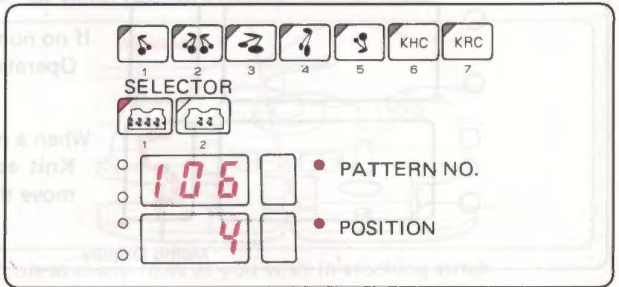

### Example: PATTERN PROGRAM

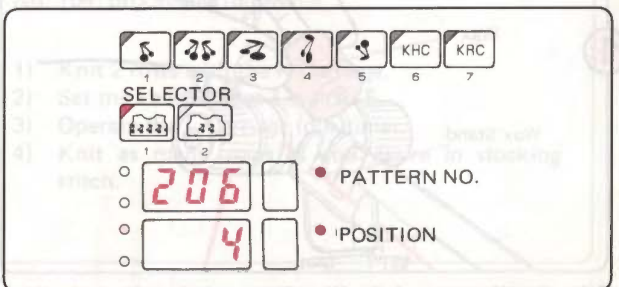

**You must use the Lace Carriage (L-Carriage) for Lace or Fine Lace Pattern.**

The methods for knitting Lace and Fine Lace Patterns are identical except the setting of the Lace Change Lever is different.

L-Carriage

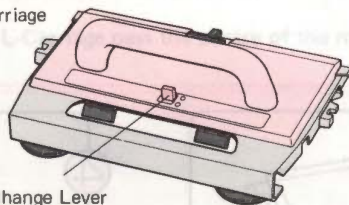

Lace Change Lever

### APPROXIMATE TENSION CHART

Very fine yarn	4-5
Fine Yarn	4-5
Medium yarn	5-6

### • HOW TO SET THE L CARRIAGE

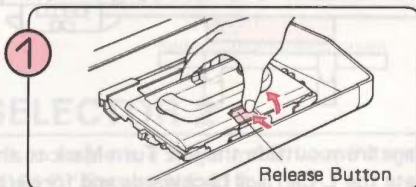

Remove the L-Carriage by pushing the Release Button.

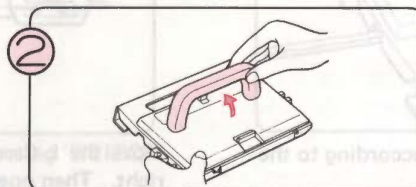

Raise the L-Carriage Handle.

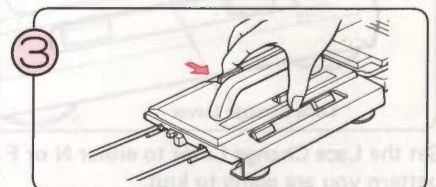

Push the Release Button and place the L-Carriage securely on the left Extension Rail.

### • BEFORE STARTING PATTERN KNITTING

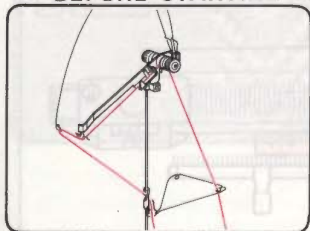

Thread the main yarn into the righthand Yarn Tension Unit.

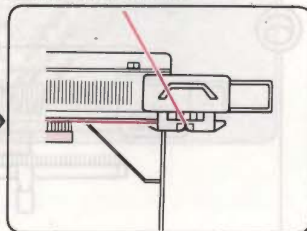

Cast on.

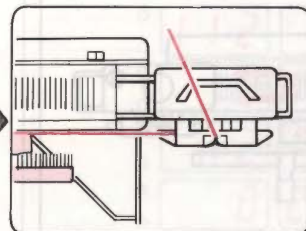

Knit a few rows in stocking stitch and place the K-Carriage on the righthand Extension Rail. Hang the Claw Weight evenly along the Cast-on Comb.

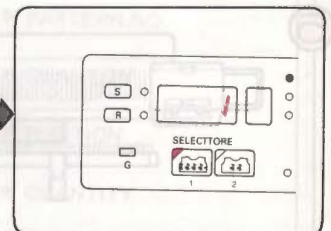

Program your pattern. (An example is given). (See p. 23.)

● PATTERN KNITTING

Use either the L-Carriage or the K-Carriage according to the Memo Display when knitting Lace or Fine Lace Patterns.

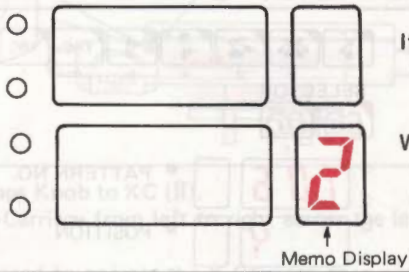

If no number appears:  
Operate the L-Carriage until a number shows in the Memo Display.

When a number appears:  
Knit as many rows with the K-Carriage as the number indicates, then move the L-Carriage from left to right.

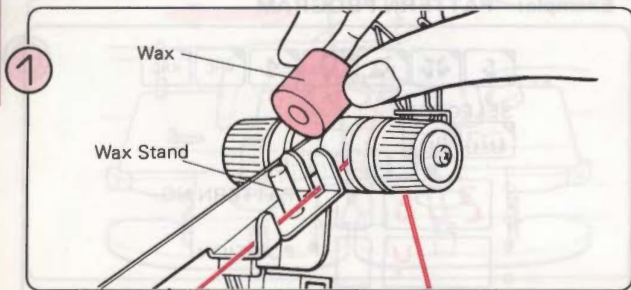

Take the Wax out of the Wax Case and place it on the Wax Stand.

\*You need to use the Wax when you are knitting Lace or Fine Lace Patterns.

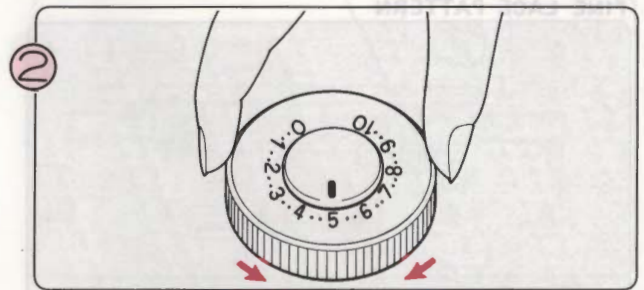

Set the Tension Dial according to the yarn you are using. (Refer to the Approximate Tension Chart on page 100.)

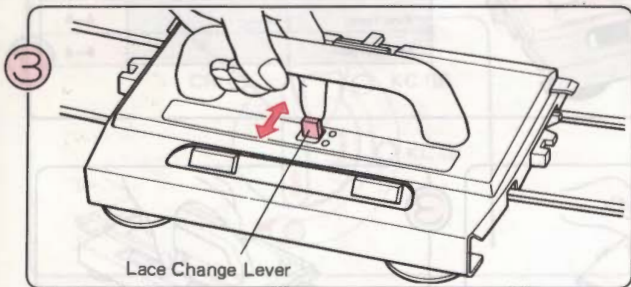

Set the Lace Change Lever to either N or F according to the pattern you are going to knit.

N - Normal Lace Pattern

F - Fine Lace Pattern

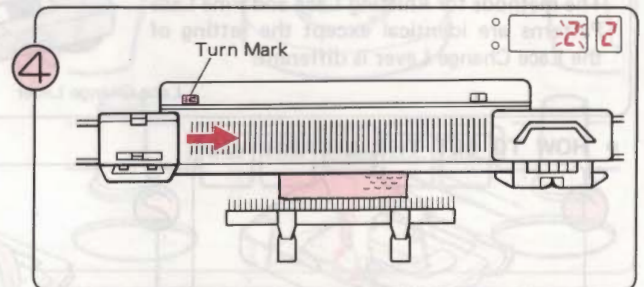

Move the L-Carriage from outside the left Turn Mark to the right. Then operate the L-Carriage backwards and forwards across the knitting until the number 2 appears in the Memo Display.

\*You only need to operate the L-Carriage once across the Turn Mark when you start pattern knitting.

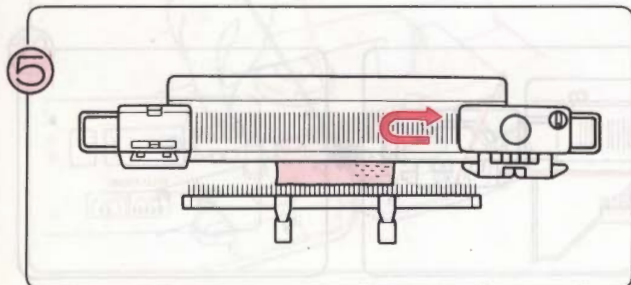

Knit two rows with the K-Carriage.

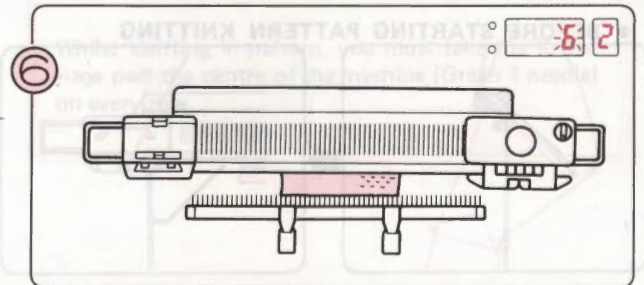

Operate the L-Carriage until a number appears in the Memo Display.

Operate the K and L-Carriages according to the Memo Display.

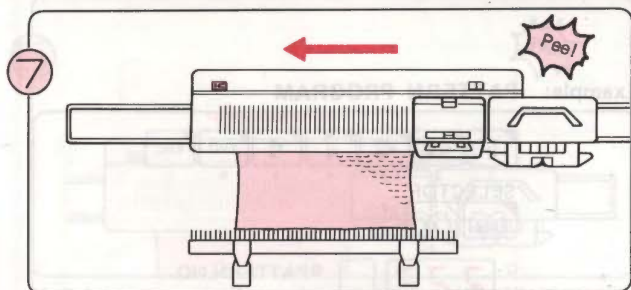

Knit in pattern until you hear the sound "Pee!". If you are operating the L-Carriage when you hear the sound, finish that row.

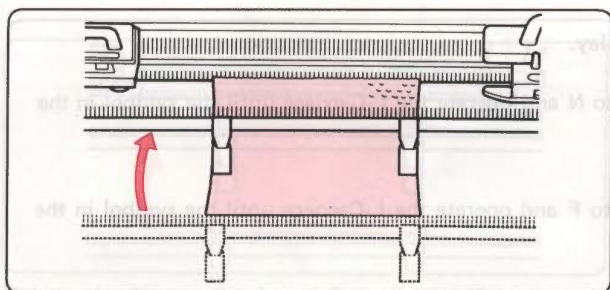

Rehang the Cast-on Comb and Claw Weights if the knitting becomes too long.  
\*Should the knitting lift, pull it down with your other hand whilst you knit.

Whilst knitting in pattern, you must take the L-Carriage past the centre of the machine (Green 1 needle) on every row.

- You can either continue:  
Repeat Steps 6 - 7.
- Or finish pattern knitting ...

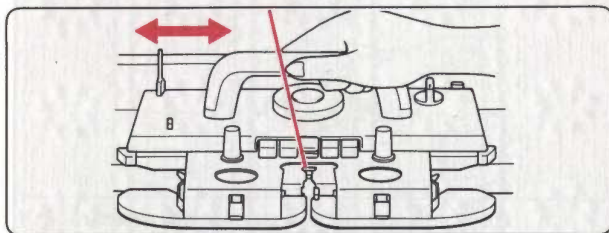

Knit as many rows as you wish in stocking stitch.

When you finish knitting "STITCH WORLD" Pattern No. 104, proceed as follows:-

- 1) Knit 2 rows with the K-Carriage.
- 2) Set the Lace Change Lever to F.
- 3) Operate the L-Carriage four times.
- 4) Knit as many rows as you desire in stocking stitch.

## SELECTOR 2

This example is a single motif Lace Pattern using "STITCH WORLD" Pattern No. 112.

(You can also knit Fine Lace Patterns in the same way.)



### Example: PATTERN PROGRAM

					KHC	KRC
1	2	3	4	5	6	7
1	2					
○	112	○	• PATTERN NO.			
○	21	○	• QUANTITY			
○	121	○	• POSITION			
○	02	○	• QUANTITY			

The procedure is the same as that for Selector (1) so refer to page 100.  
(When programming the pattern, refer to page 30.)

# LACE AND FINE LACE MIXED

- This example was knitted using "STITCH WORLD" Pattern No. 222.

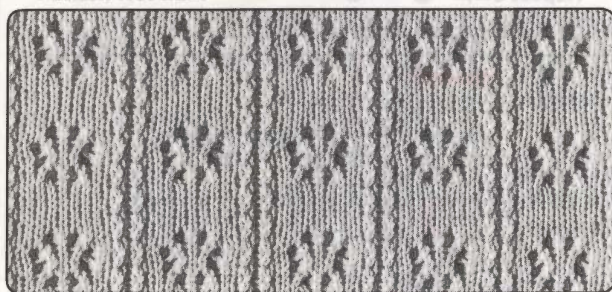

## Example: PATTERN PROGRAM

SELECTOR

1 2 3 4 5 6 7

1 2

○ 222

● PATTERN NO.

○ 6

● POSITION

## • PATTERN KNITTING

Use the L-Carriage and the K-Carriage as indicated in the Memo Display.

- Set the Lace Change Lever to N and operate the L-Carriage until the symbol in the Memo Display changes.
- Set the Lace Change Lever to F and operate the L-Carriage until the symbol in the Memo Display changes.
- When a number appears in the Memo Display ...  
Knit as many rows with the K-Carriage as the number indicates, and then move the L-Carriage from left to right.

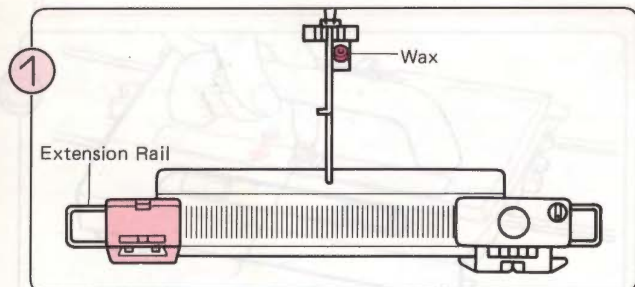

Set the L-Carriage by referring to page 100 and follow Steps on page 100 and Steps ① – ② on page 101.

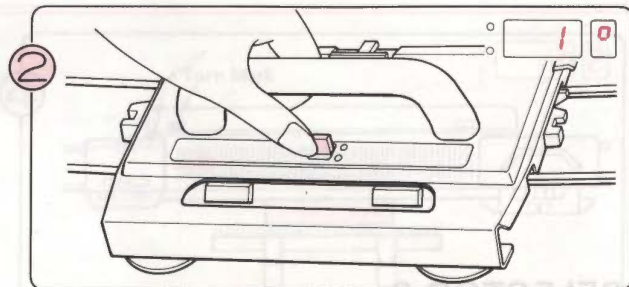

Set the Lace Change Lever to N which corresponds to the symbol " " in the Memo Display.

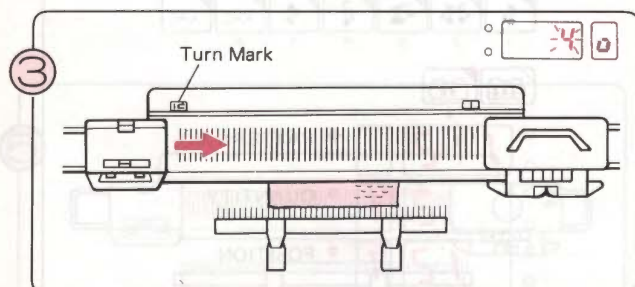

Move the L-Carriage from outside the left Turn Mark to the right. Then operate the L-Carriage backwards and forward across the knitting until the symbol in the Memo Display changes.

\*You only need to operate the L-Carriage once across the Turn Mark when you start pattern knitting.

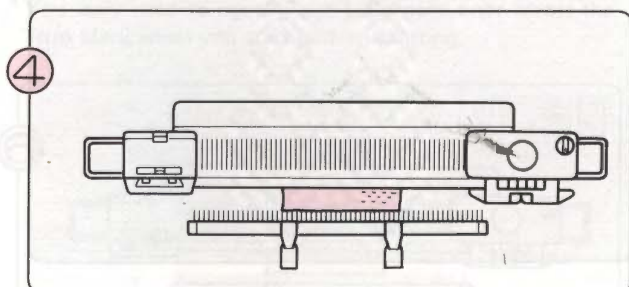

Operate the K and L Carriages according to the Memo Display.

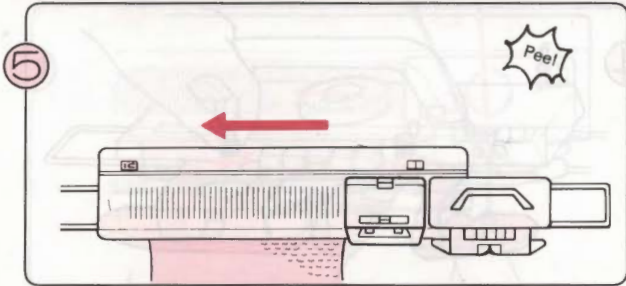

Knit in pattern until you hear the sound "Peel". If you are operating the L-Carriage when you hear the sound, finish that row.

- You can either continue:  
Repeat Steps ④ – ⑤ .
- Or finish pattern knitting ...

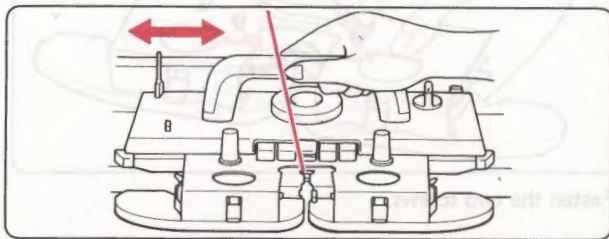

Knit as many rows as you wish in stocking stitch.

## CHANGING THE MAIN YARN AND THE PLATING YARN

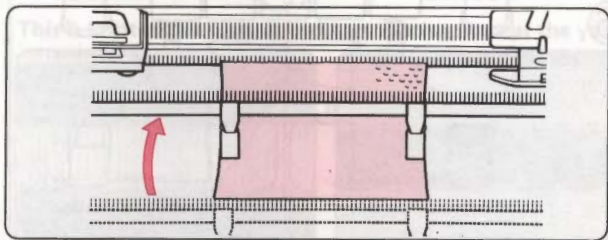

Rehang the Cast-on Comb and Claw Weights if the knitting becomes too long.

\*Should the knitting lift, pull it down with your other hand whilst you knit.

Whilst knitting in pattern, you must take the L-Carriage past the centre of the machine (Green 1 needle) on every row.

## PLATING

With the Plating Yarn Feeder, you can use two yarns to knit a reversible fabric, with one colour on the right side and the other on the wrong side. The main yarn will be on the front (plain) side of the knitting and the plating yarn will be on the reverse (purl) side.

The setting for the K-Carriage is the same as for stocking stitch. Prepare your two yarns – use fine or very fine yarn.

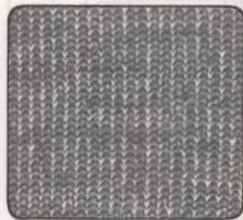

Front (Plain)

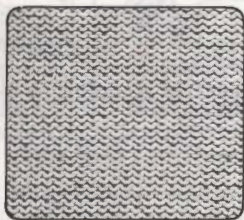

Reverse (Purl)

### APPROXIMATE TENSION CHART

MAIN YARN	PLATING YARN	TENSION DIAL
Very fine	Very fine	4–5
Fine	Very fine	6–7
Fine	Fine	8–9

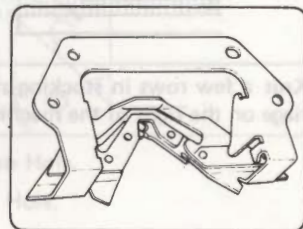

Plating Yarn Feeder

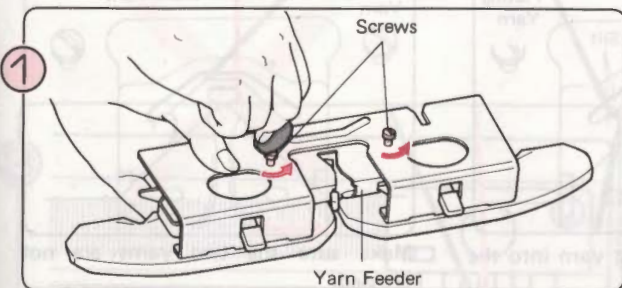

Remove the two screws and the Yarn Feeder from the Sinker Plate Assembly.

\*Be sure to keep the screws safely !.

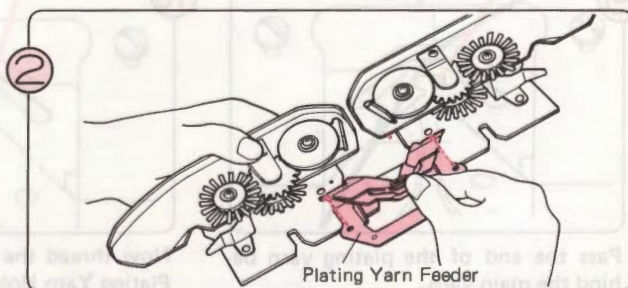

Take the Plating Yarn Feeder out of the Accessory Box and fit it into the Sinker Plate Assembly as shown above.

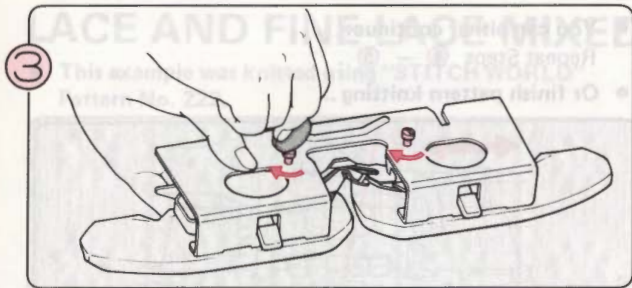

Fasten the two screws.

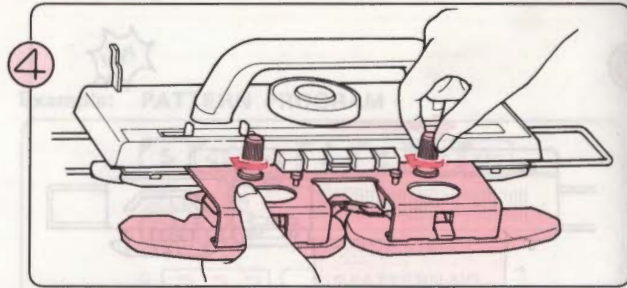

After you have changed the Yarn Feeder, screw the Sinker Plate Assembly back on the K-Carriage.

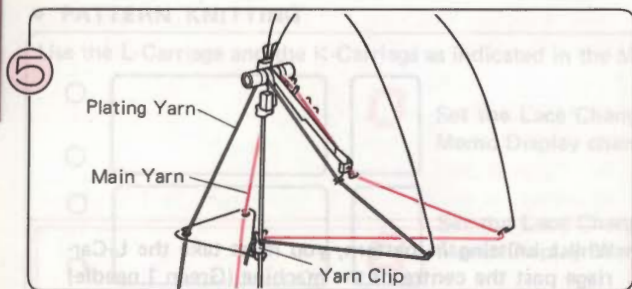

Thread the yarns into the Yarn Tension Unit as shown.

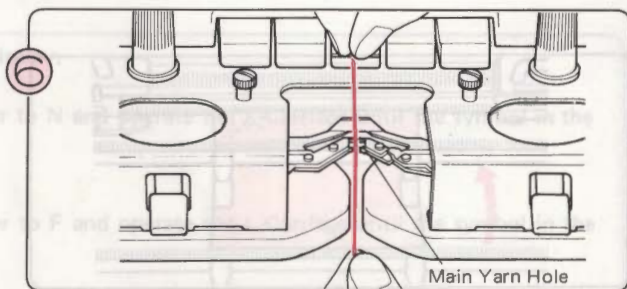

Thread the main yarn into the Main Yarn Hole.

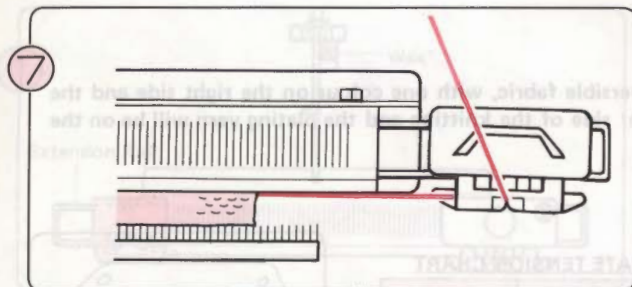

Knit a few rows in stocking stitch, ending with the K-Carriage on the right of the machine.

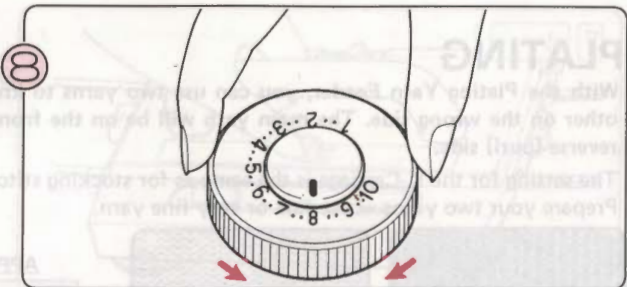

Set the Tension Dial according to the yarn you are using.

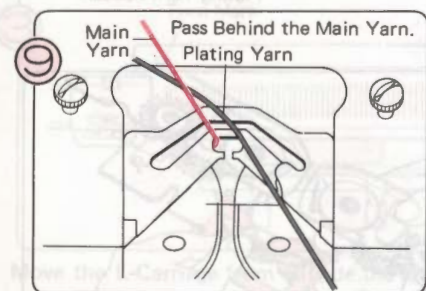

Pass the end of the plating yarn behind the main yarn.

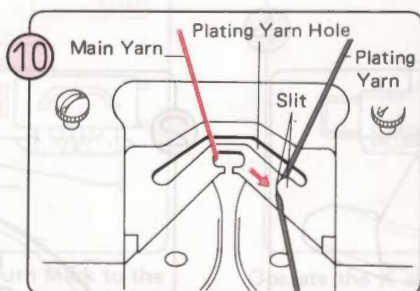

Now thread the plating yarn into the Plating Yarn Hole. There is an opening at the side and you can pass the yarn through this slit.

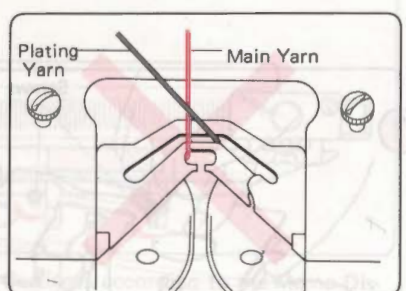

Make sure the two yarns are not crossed.

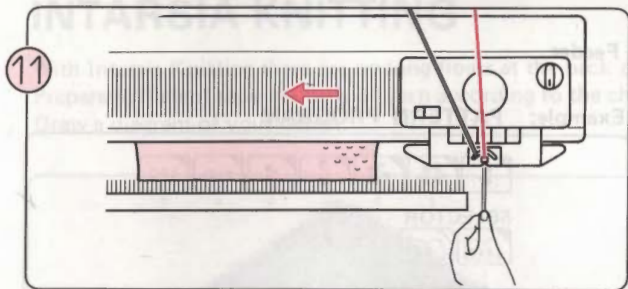

Hold the end of the plating yarn with your left hand, and move the K-Carriage to the left. Once the needles have caught the yarn, you can release the yarn end. Continue knitting in this way. You are now knitting plating.

## CHANGING THE MAIN YARN AND THE PLATING YARN

This is knitted the same as ordinary Plating, except the yarns are changed.

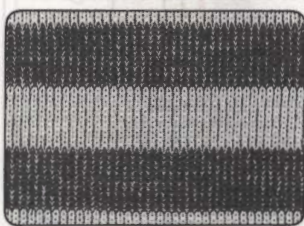

Front (Plain)

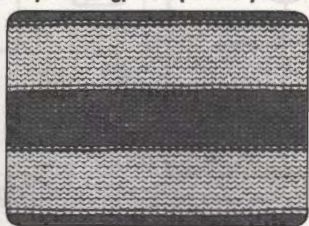

Reverse (Purl)

\*Set the Tension Dial using the Approximate Tension Chart on page 104 as a guide.

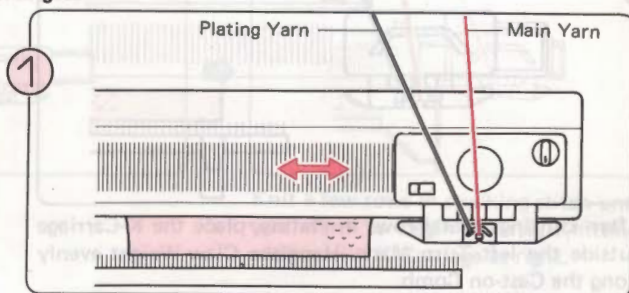

Follow the Steps given for Plating and continue knitting until you want to change the yarn.

② To change the yarn, do as follows:-

- (1) When the K-Carriage is on the left of the needlebed.      When the K-Carriage is on the right of the needlebed.

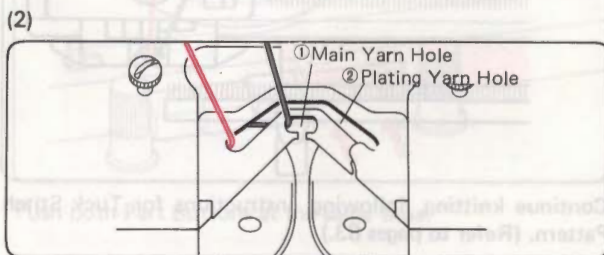
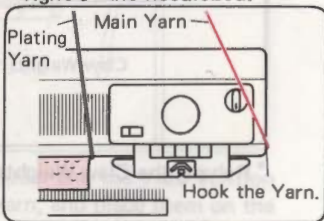
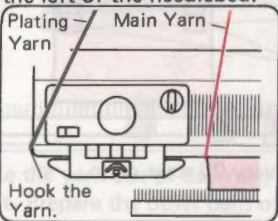

1. Thread up the Plating Yarn Hole.
2. Thread up the Main Yarn Hole.

1. Take the yarn out of the Main Yarn Hole.
2. Take the yarn out of the Plating Yarn Hole.
  - \*Hook the yarn in the right Yarn Tension Unit into the righthand notch.
  - \*Hook the yarn in the left Yarn Tension Unit into the lefthand notch.

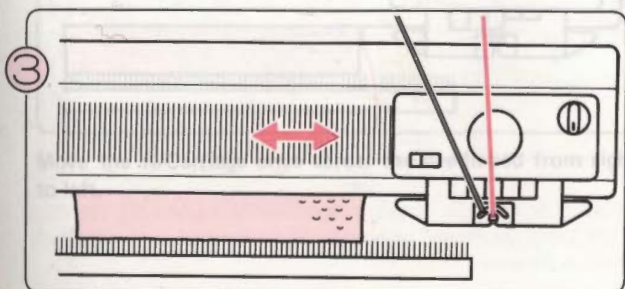

Continue knitting, changing the yarn when you wish.

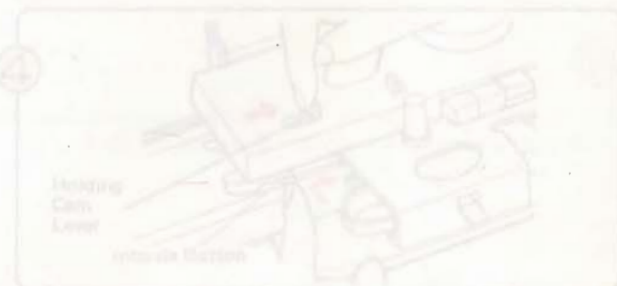

Set the Holding Cam Lever to 0. To do this, slide the Holding Cam Lever to the right at the same time press in the Tension Button.



# PLATED TUCK STITCH PATTERN

This is knitted the same as Tuck Stitch Pattern, using the Plating Yarn Feeder.

This example was knitted using "STITCH WORLD" Pattern No. 321.

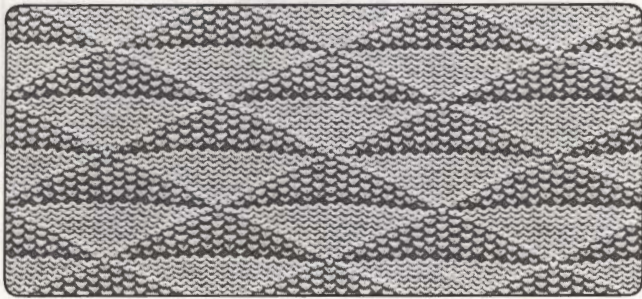

Example: **PATTERN PROGRAM**

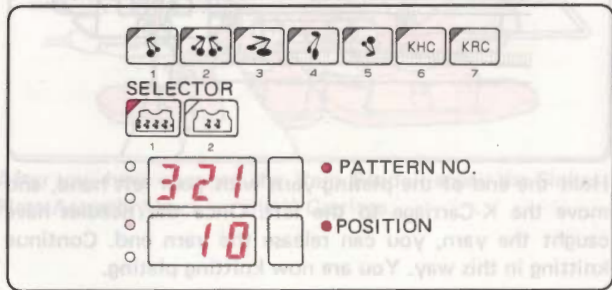

## • PATTERN KNITTING

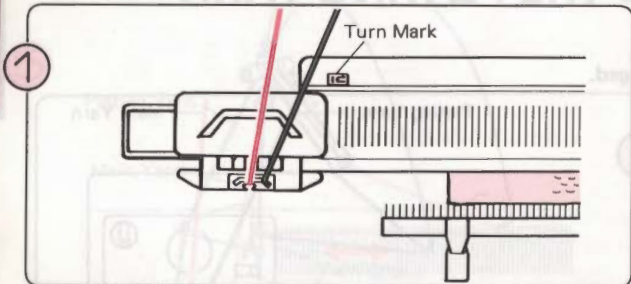

After knitting several rows in Plating, place the K-Carriage outside the left Turn Mark. Hang the Claw Weight evenly along the Cast-on Comb. (Refer to page 104.)

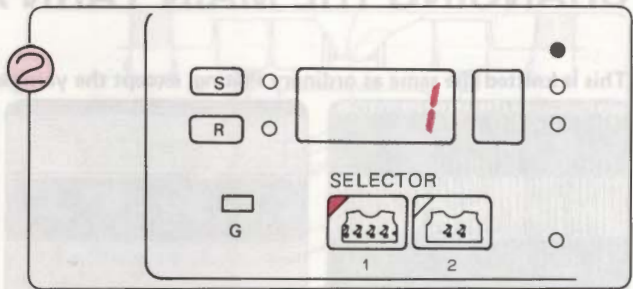

Program your pattern. (Refer to page 23.)

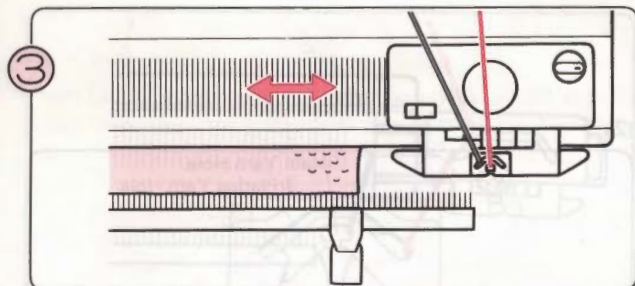

Continue knitting, following instructions for Tuck Stitch Pattern. (Refer to pages 83.)

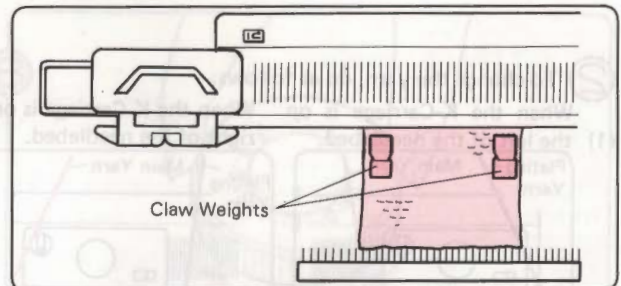

\* Rehang the Claw Weights every 20 rows or so.

# INTARSIA KNITTING

With Intarsia Knitting there are no long floats at the back of the fabric, and several colours can be knitted in one row. Prepare sufficient separate balls of yarn according to the changes in the pattern and place these on the floor at your feet. Draw a diagram of your design.



When you do Intarsia Knitting, the tension may differ about 1 and can even vary according to how firmly you hold the yarn with your hand. Bear in mind this possible difference when making your tension swatches.

## • BEFORE STARTING PATTERN KNITTING

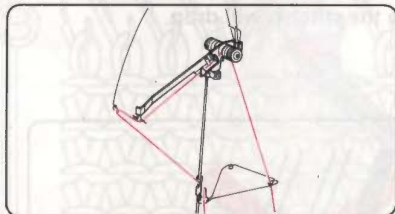

Thread the main yarn into the right-hand Yarn Tension Unit.

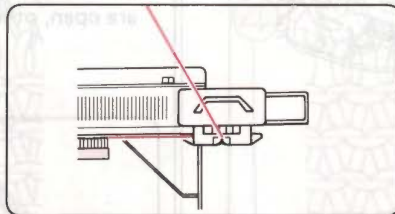

Cast on.

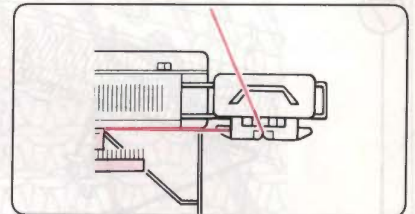

Knit a few rows in stocking stitch until you want to begin Intarsia Knitting, ending with K-Carriage at right.

## • PATTERN KNITTING

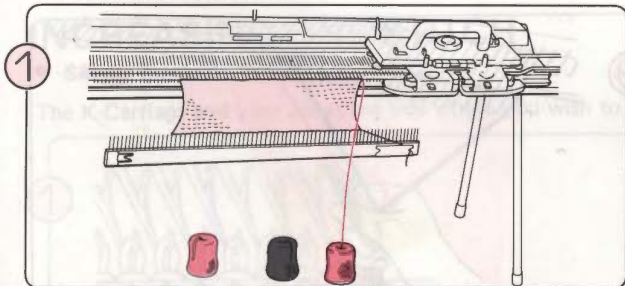

Take the yarn out of the Yarn Feeder and the Yarn Tension Unit. Prepare the other balls of yarn, and place them on the floor at your feet.

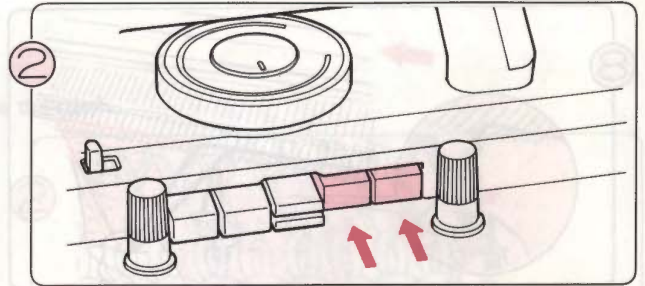

Push both Part Buttons at the same time.

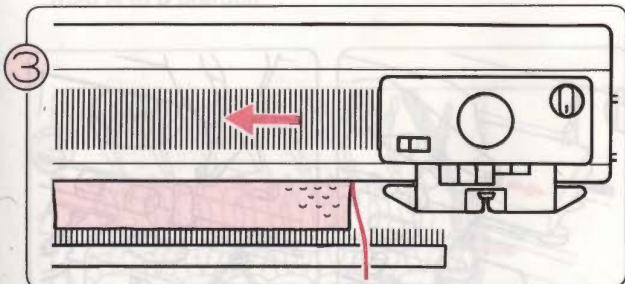

Move the K-Carriage once across the needlebed from right to left.

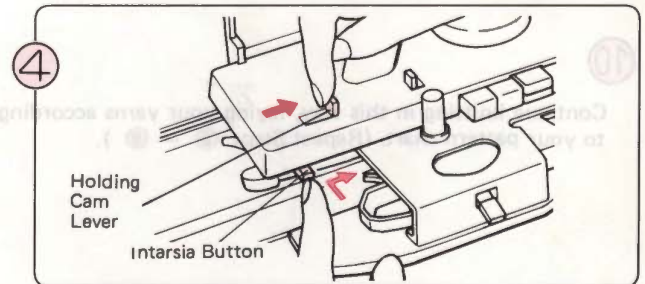

Set the Holding Cam Lever to I. To do this, slide the Holding Cam Lever to the right at the same time press in the Intarsia Button.

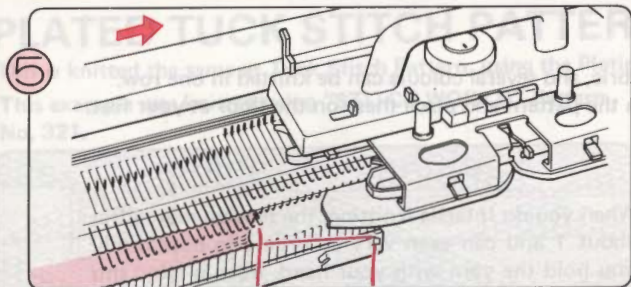

5 Move the K-Carriage from left to right, without knitting, to align the needles in D position. Make sure that all the latches are open. If not, open them. Wind the Row Counter and Knitleader back by 2 rows.

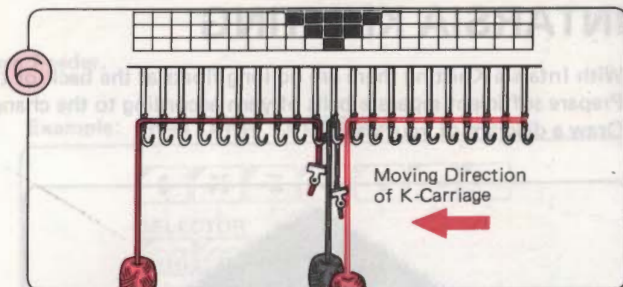

6 Beginning at the side nearest to the K-Carriage, and working away from the K-Carriage, lay the yarns in the open needle hooks as illustrated.

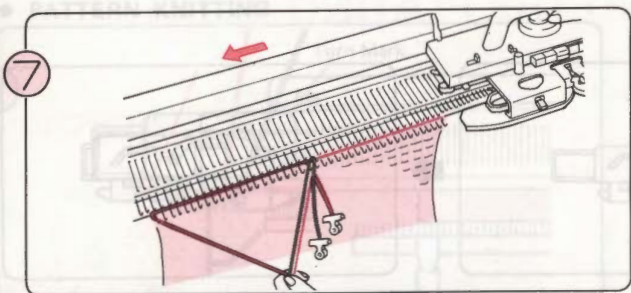

7 Move the K-Carriage slowly across the needlebed, at the same time gently pull the yarns downwards with your other hand to take up any looseness.

\*When working Intarsia, always make sure the latches are open, otherwise the stitches will drop.

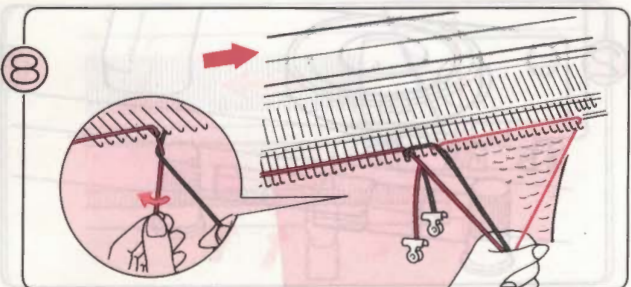

8 Working in the opposite direction (again away from the K-Carriage) lay the yarns in the open needle hooks for the next row. To avoid a hole appearing where the yarns meet, cross one over the other as illustrated. Now slowly move the K-Carriage across the needlebed.

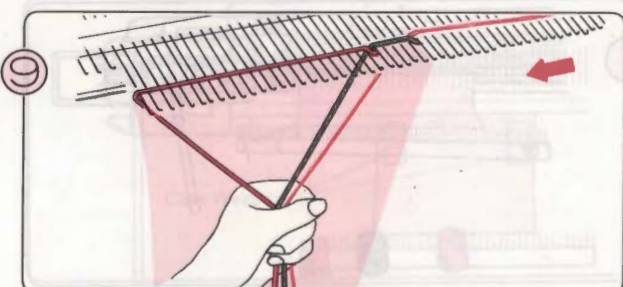

9 Lay the yarns and knit the third row.

10 Continue knitting in this way, laying your yarns according to your pattern chart. (Repeat Steps 8 - 9).

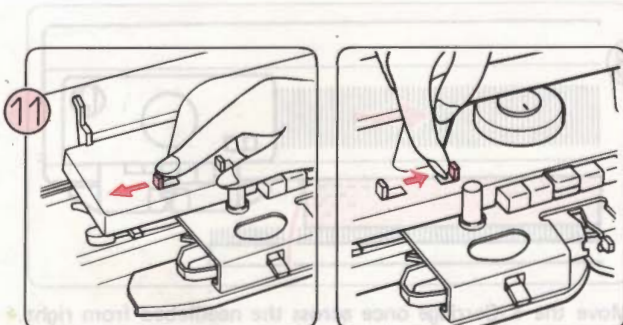

11 When you want to finish Intarsia Knitting, set the Holding Cam Lever to N and release the Cam Buttons with the Cam Button Release Lever.

# MAKING GARMENTS

## HOW TO TRANSFER STITCHES

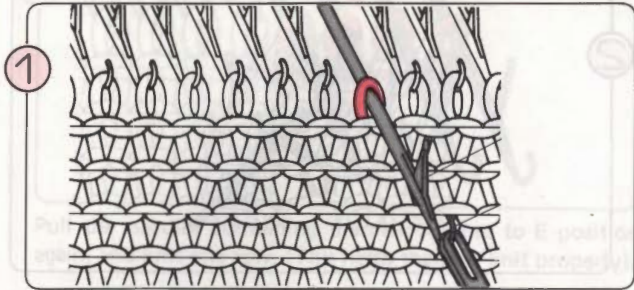

Place the eye of a single Transfer Tool over the needle hook, and pull the needle towards you until the stitch passes behind the latch.

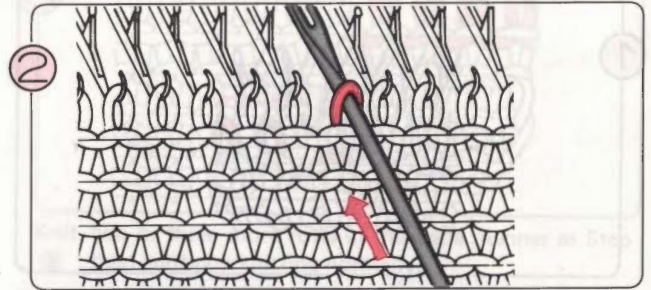

Holding the Transfer Tool in line with the needle, use it to push the needle back so that the stitch slips onto the Transfer Tool.

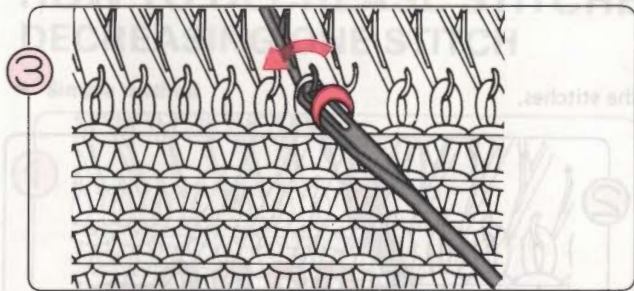

Lift the Transfer Tool together with the stitch, and place it onto the adjacent needle.

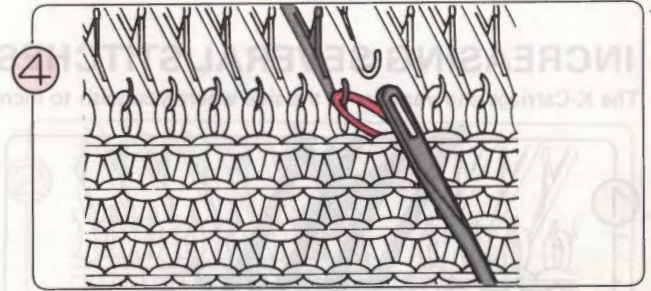

Lift the Transfer Tool slightly so that the stitch slides off into the hook of the needle. Then remove the Transfer Tool. One stitch has been transferred.

## HOW TO INCREASE STITCHES

### INCREASING ONE STITCH

#### • Simple method

The K-Carriage and yarn are at the side where you wish to increase the stitch.

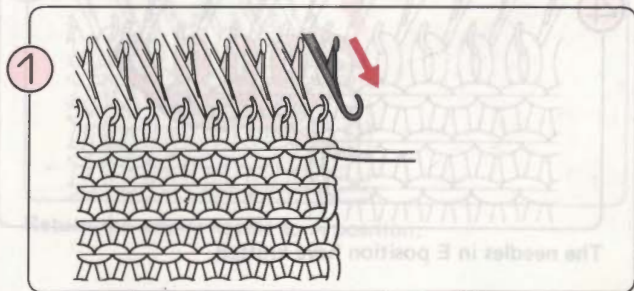

On the K-Carriage side, bring one edge needle forward from A to B position.

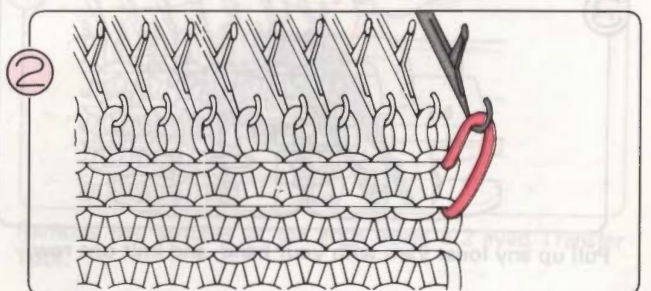

Knit one row to the left. The empty needle picks up the yarn.

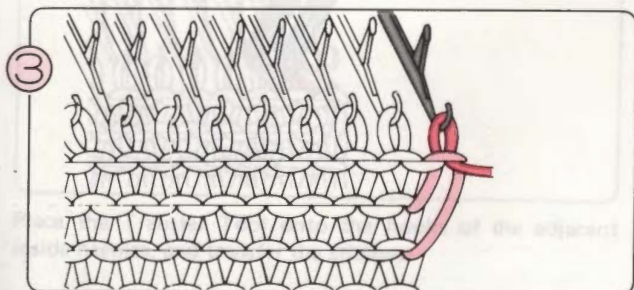

Knit one row to the right. The new stitch knits.

● **Fully fashioned method**

The K-Carriage can be at either end of the needlebed.

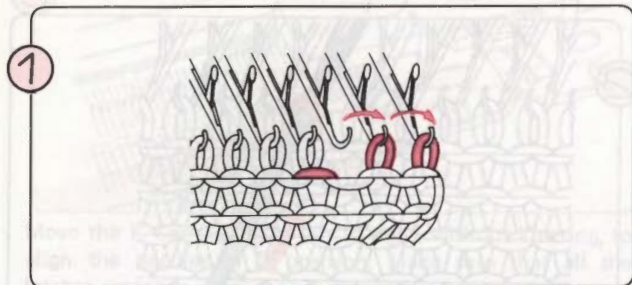

Using the 1 x 2 Transfer Tool, move two stitches out by one needle, so that the third needle from the edge becomes empty.

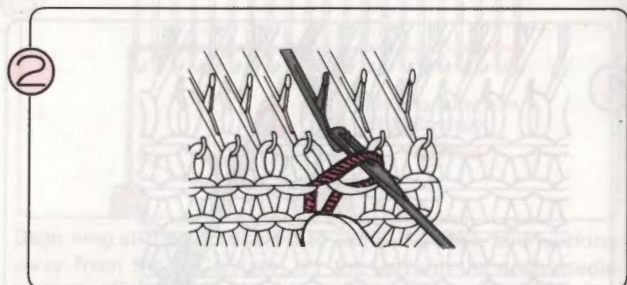

Pick up the loop as shown using the Transfer Tool. Place this loop onto the empty needle and continue to knit.

## INCREASING SEVERAL STITCHES

The K-Carriage and yarn are at the side where you wish to increase the stitches.

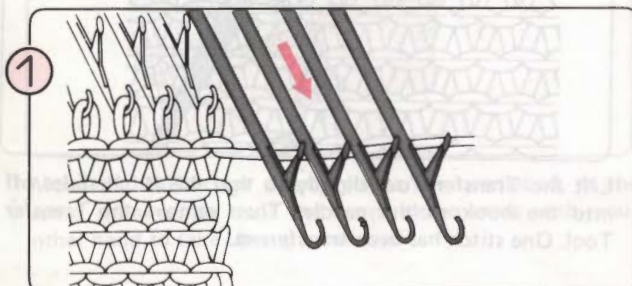

On the K-Carriage side, bring the needles to be increased forward from A position to E position.

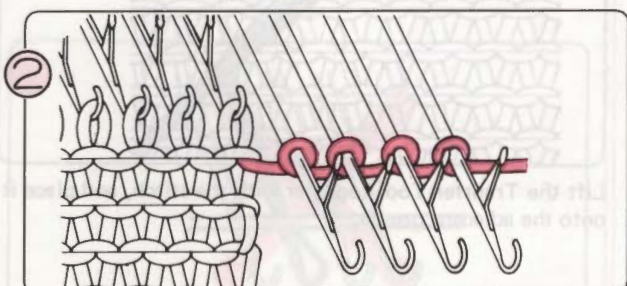

Wind the yarn loosely around the stem of each needle as shown.

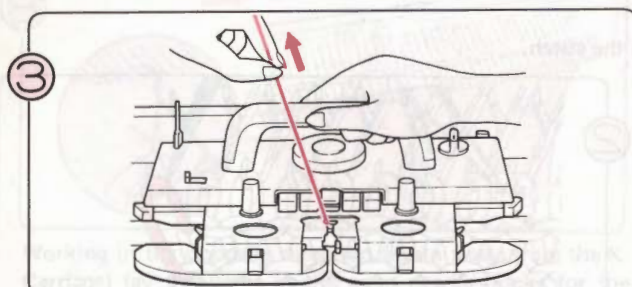

Pull up any loose yarn with your hand, and knit one row.

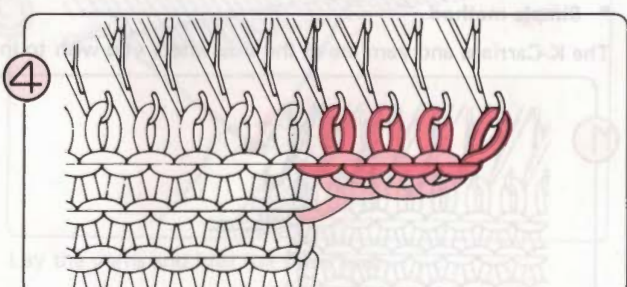

The needles in E position have knitted.

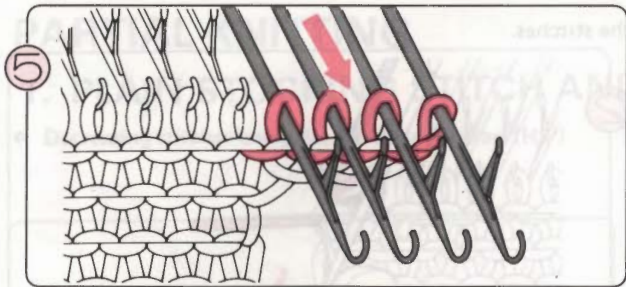

5 Pull the needles containing the new stitches to E position again, and knit one row. (This helps them to knit properly).

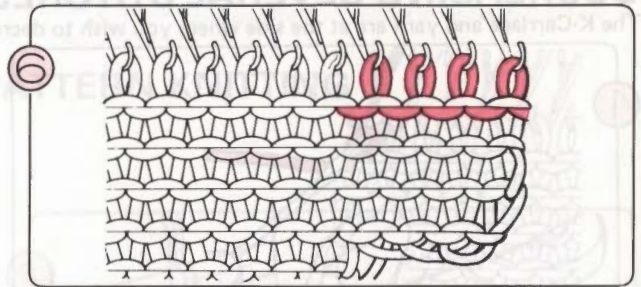

6 Knit two or three more rows in the same manner as Step 5, then continue knitting normally.

## HOW TO DECREASE STITCHES DECREASING ONE STITCH

### • Simple method

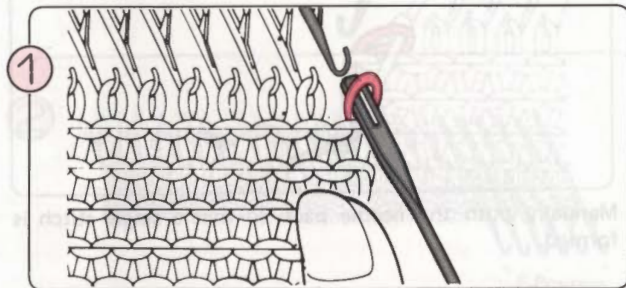

1 Remove one stitch at the edge onto your Transfer Tool.

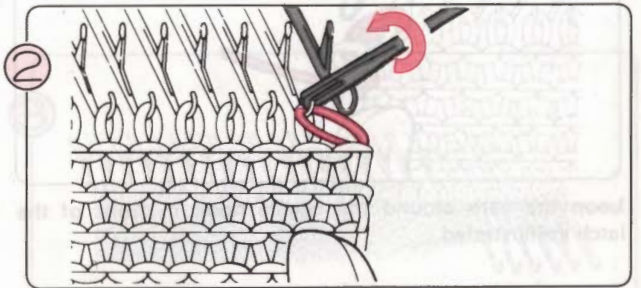

2 Place the Transfer Tool onto the hook of the adjacent inside needle, and transfer the stitch.

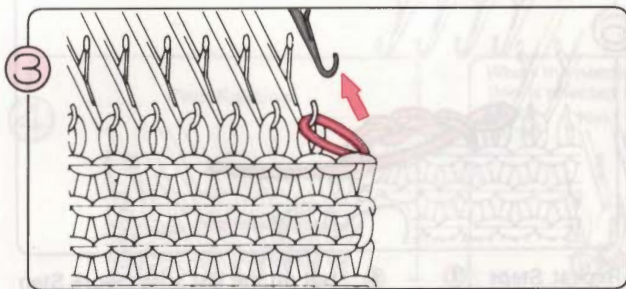

3 Return the empty needle to A position.

### • Fully fashioned method

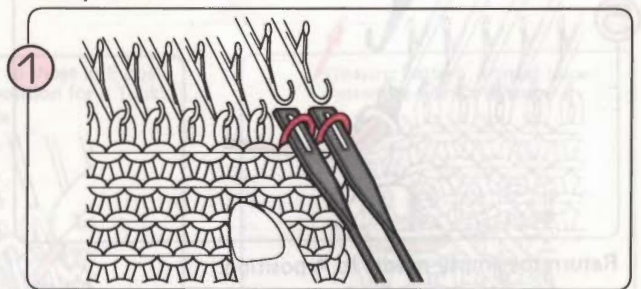

1 Remove two stitches at the edge using a 2 eyed Transfer Tool.

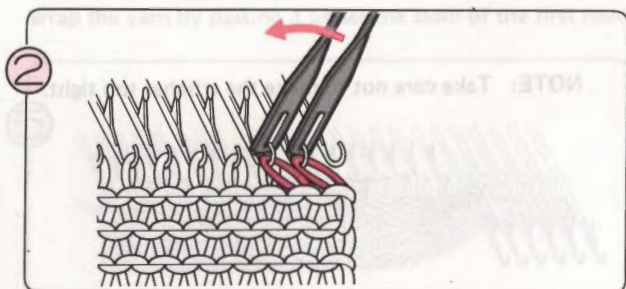

2 Place the Transfer Tool onto the hooks of the adjacent inside needles, and transfer the stitches.

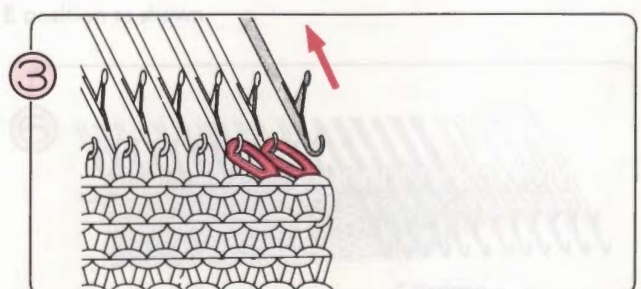

3 Return the empty needle to A position.

## DECREASING SEVERAL STITCHES

The K-Carriage and yarn are at the side where you wish to decrease the stitches.

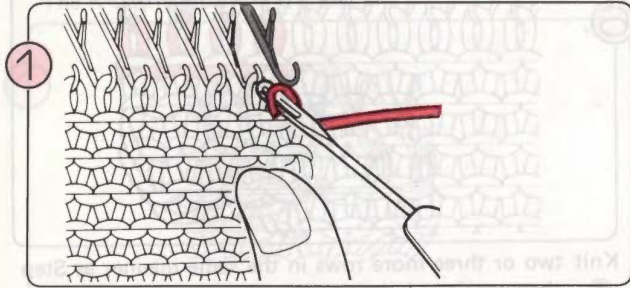

On the K-Carriage side, transfer the end stitch onto the adjacent inside needle.

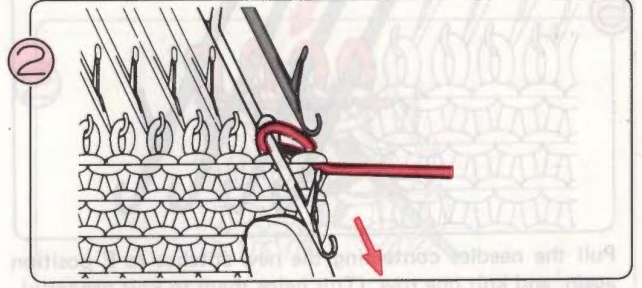

Bring this needle forward so that the two stitches are behind the latch.

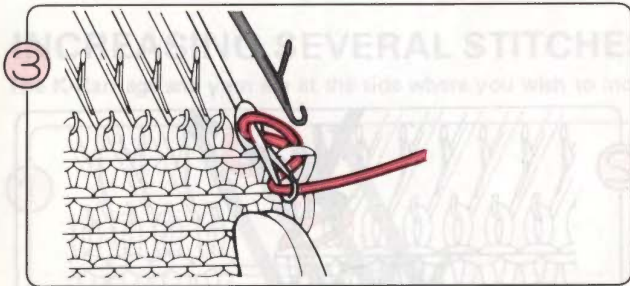

Loop the yarn around the needle hook in front of the latch as illustrated.

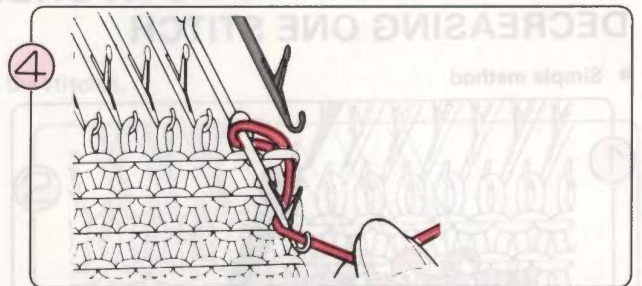

Manually push the needle back so that a single stitch is formed.

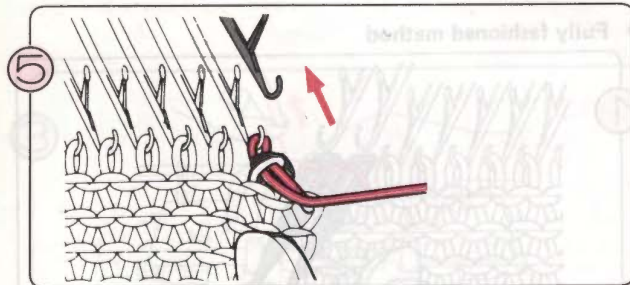

Return the empty needle to A position.

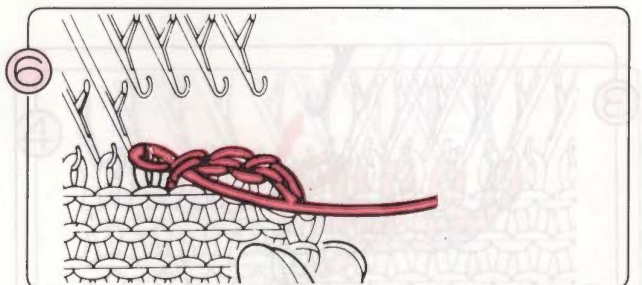

Repeat Steps ① - ⑤, but on the last stitch work Step ① only.

**NOTE:** Take care not to make the stitches too tight.

# PARTIAL KNITTING

## 1. PLAIN STOCKING STITCH AND PATTERN KNITTING

- Decreasing stitches using the Holding Position (H.P)

When working decreases for shoulders, neck opening etc., set the Holding Cam Lever on the K-Carriage to H.

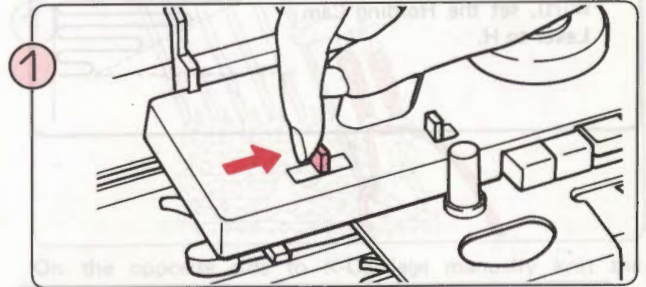
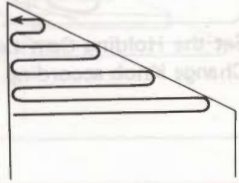

Set the Holding Cam Lever to H and the Cam Buttons and Change Knob according to the pattern.

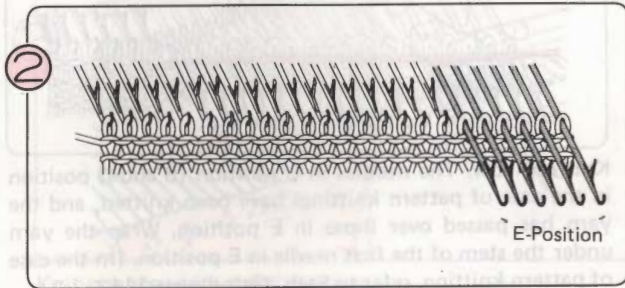

On the opposite side to the K-Carriage, bring the needles you want to decrease forward to E position.

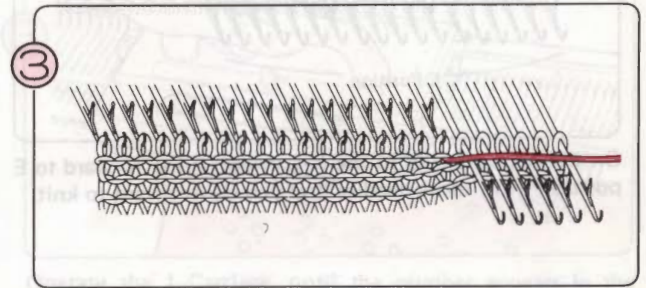

Knit one row. The needles in B position (B and D position in the case of pattern knitting) have been knitted and those in E position have not been knitted.

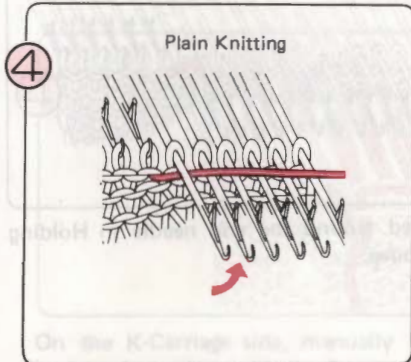

Wrap the yarn by passing it under the stem of the first needle in E position as shown.

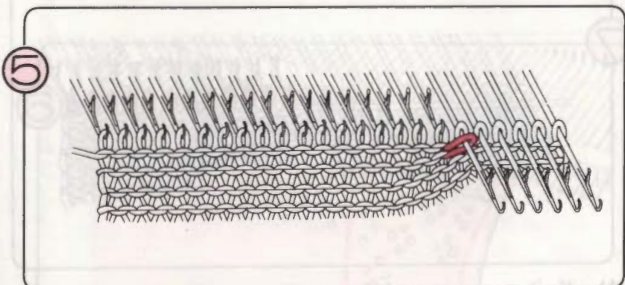
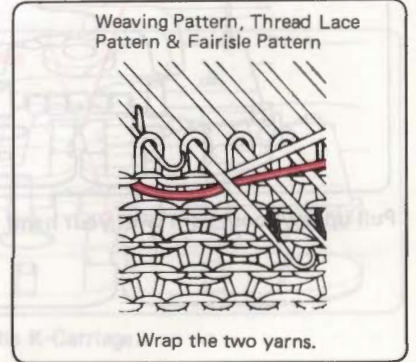
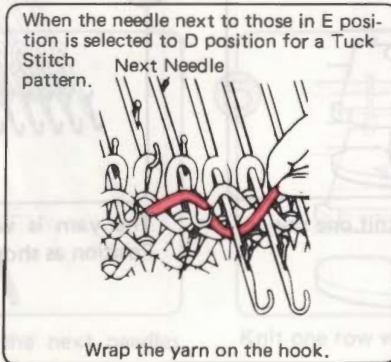

Pull up any loose yarn with your hand and knit one row. The yarn is wrapped around the end needle in Holding Position as shown above.

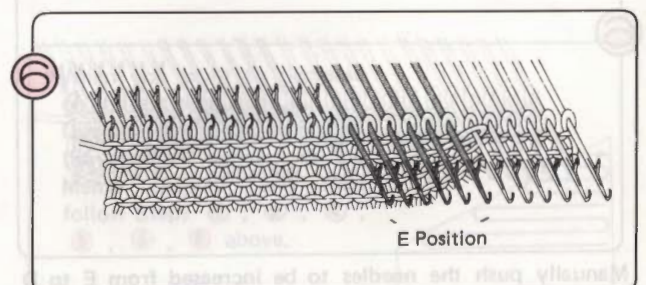

Continue moving needles to be decreased into E position, repeating Steps 3 - 5.

\* After partial knitting is complete, return the Holding Cam Lever to N.



● Increasing stitches using the Holding Position (H.P)

- When working increases (for example the hemline of a skirt), set the Holding Cam Lever to H.

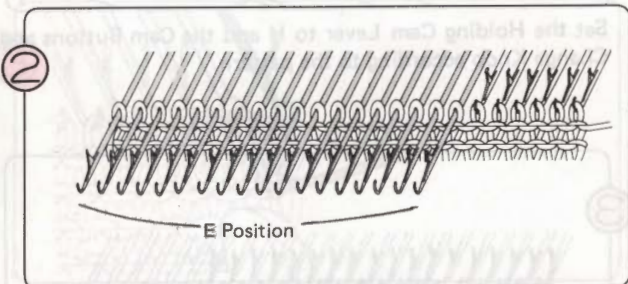
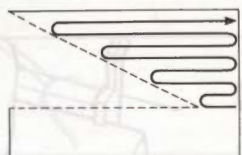

On the opposite side to the K-Carriage, bring forward to E position (H.P) those needles that you do not want to knit.

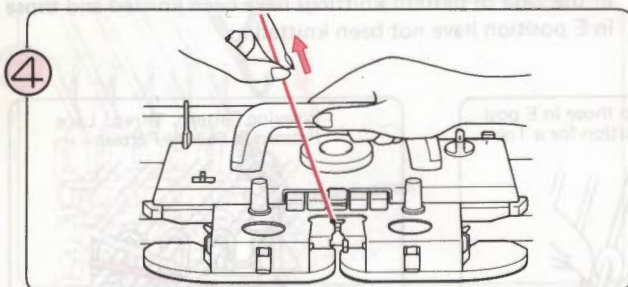

Pull up any loose yarn with your hand and knit one row.

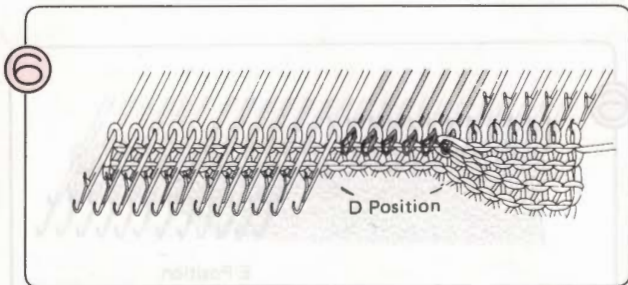

Manually push the needles to be increased from E to D position.

\*For pattern knitting, put the appropriate needles to B position according to the pattern. When you return these needles from D to B position, place the stitches into the needlehooks using the Transfer Tool.

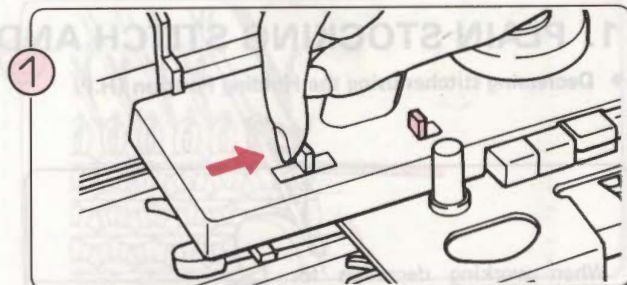

Set the Holding Cam Lever to H and the Cam Buttons and Change Knob according to the pattern.

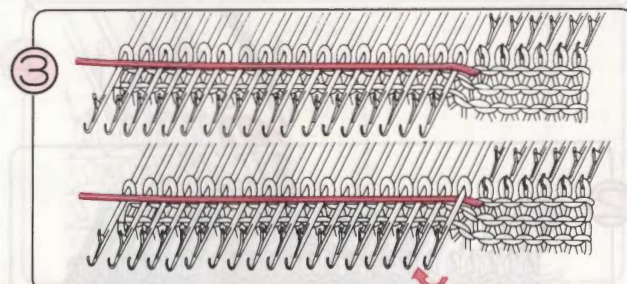

Knit one row. The needles in B position (B and D position in the case of pattern knitting) have been knitted, and the yarn has passed over those in E position. Wrap the yarn under the stem of the first needle in E position. (In the case of pattern knitting, refer to Step 4 on page 114.)

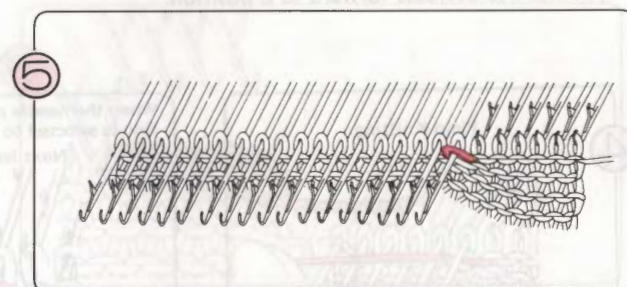

The yarn is wrapped around the end needle in Holding Position as shown above.

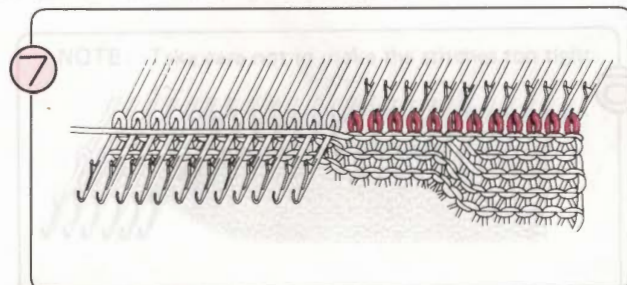

1) Knit one row and the needles you brought to D position will have been knitted.

2) Repeat Steps 3 - 6.

\* After partial knitting is complete, return the Holding Cam Lever to N.

## 2. LACE OR FINE LACE PATTERN KNITTING

The method you use will depend on which side you work your partial knitting.

### • Decreasing stitches

- When you want to decrease on the right hand side... Move the K-Carriage to the left when the number appears in the Memo Display then start partial knitting.

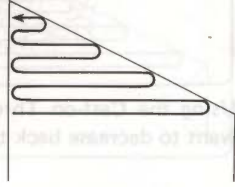

①

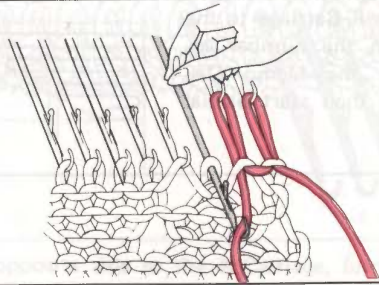

On the opposite side to K-Carriage manually knit the needles you want to decrease back to A position using the Cast-on Thread.

②

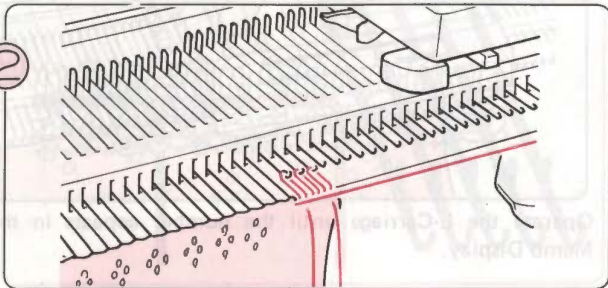

Knit one row with the K-Carriage.

③

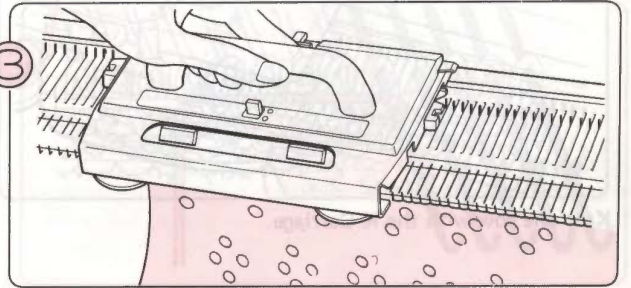

Operate the L-Carriage until the number appears in the Memo Display.

④

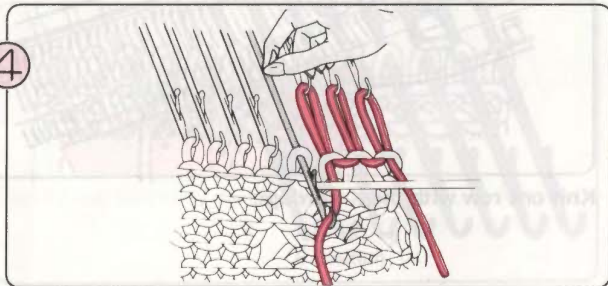

On the K-Carriage side, manually knit the next needles back to A position using the Cast-on Thread.

⑤

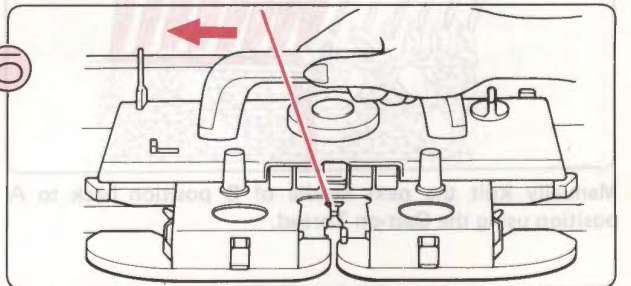

Knit one row with the K-Carriage.

⑥

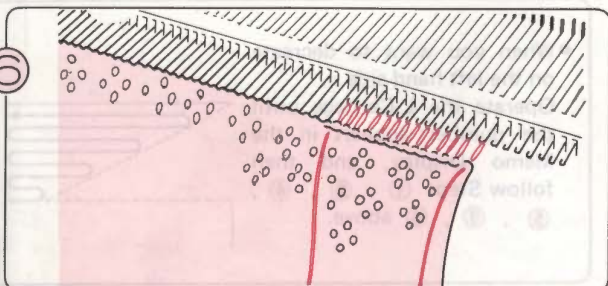

- When you want to decrease on the left hand side ... Operate the L-Carriage until the number appears in the Memo Display, and then follow Steps ①, ②, ④, ⑤, ⑥ above.

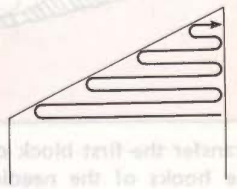

Repeat Steps ① – ⑤.

\*After partial knitting, transfer the stitches in A position back into the hooks of the needles and remove the Cast-on Thread. Place needles in B position.

● Increasing stitches

- When you want to increase on the right hand side ... Move the K-Carriage to the left when the number appears in the Memo Display, and then start partial knitting.

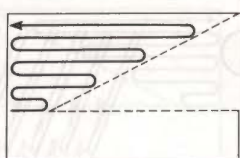

①

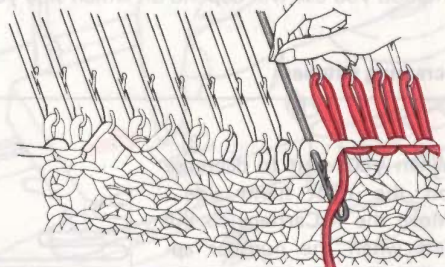

Using the Cast-on Thread, manually knit the needles you want to decrease back to A position.

②

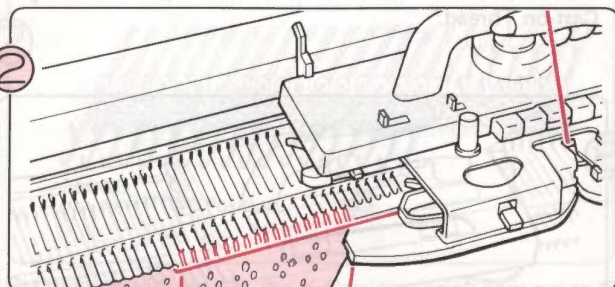

Knit one row with the K-Carriage.

③

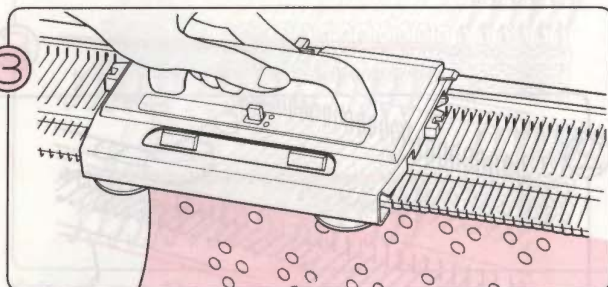

Operate the L-Carriage until the number appears in the Memo Display.

④

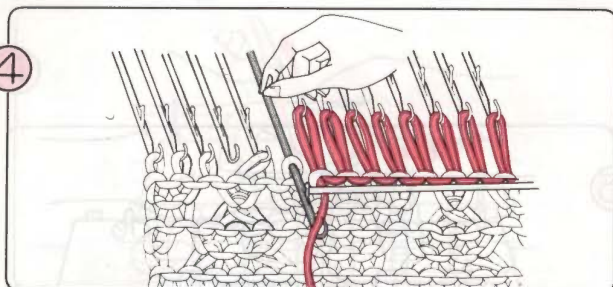

Manually knit the next needle of B position back to A position using the Cast-on Thread.

⑤

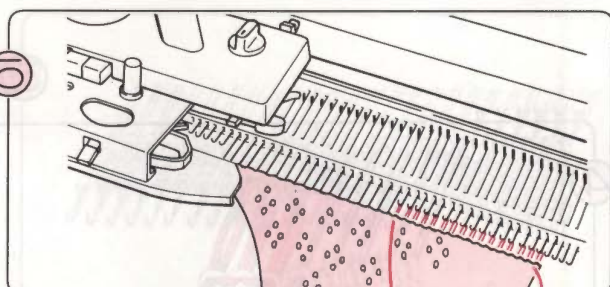

Knit one row with the K-Carriage.

⑥

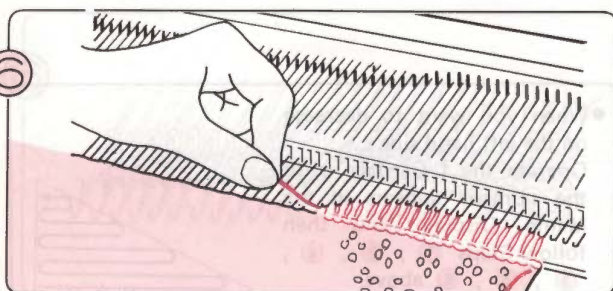

Transfer the first block of stitches in A position back into the hooks of the needles, removing the Cast-on Thread from these, and placing them in B position. Knit one row with the K-Carriage.

⑦

Repeat Steps ③ - ⑥ .

- When you want to decrease on the left hand side ... Operate the L-Carriage until the number appears in the Memo Display, and then follow Steps ① , ② , ④ , ⑤ , ③ , ⑥ above.

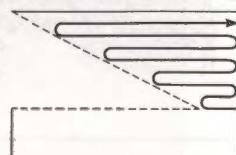

### 3. INTARSIA KNITTING

- Decreasing stitches

- When working decreases for shoulders, neck opening etc., bring the needles to be decreased forward to E position.

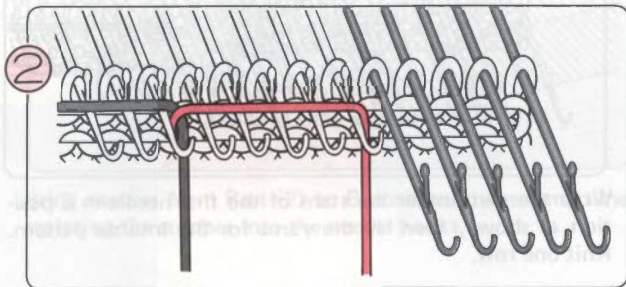
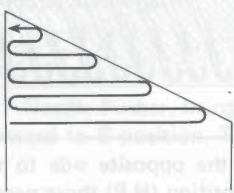

Lay the yarns for the Intarsia pattern and knit one row.

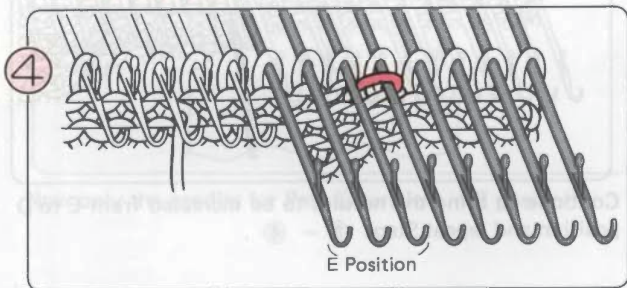

Continue to bring the needles to be decreased into E position and repeat Steps 2 - 4.

\* After partial knitting is complete, return the needles from E position to D position and continue knitting.

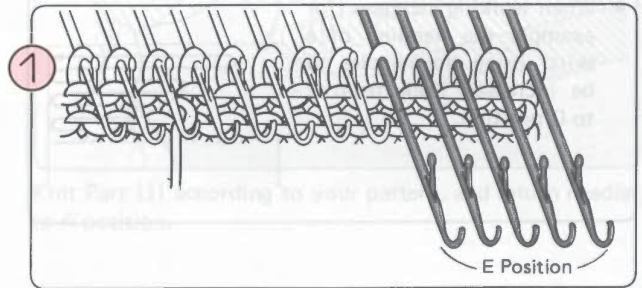

On the opposite side to the K-Carriage, bring forward to E position (H.P.) those needles that you want to decrease.

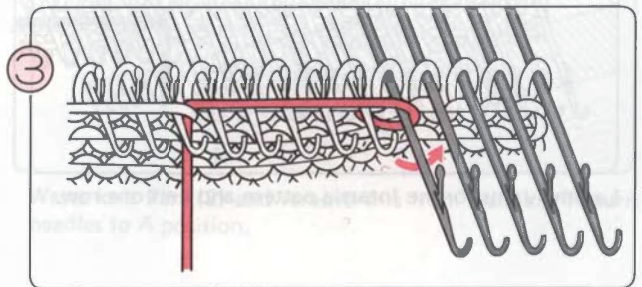

Wrap the yarn under the stem of the first needle in E position as shown, then lay the yarns for the Intarsia pattern. Knit one row.

● **Increasing stitches**

- When working increases (for example the hemline of a skirt) bring the needles to be increased back from E to D position.

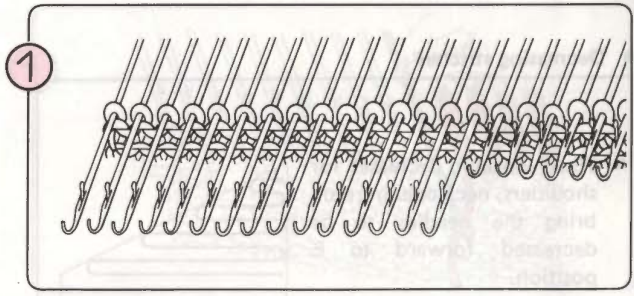
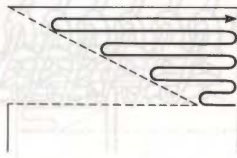

On the opposite side to the K-Carriage, bring forward to E position (H.P) those needles which you want to decrease.

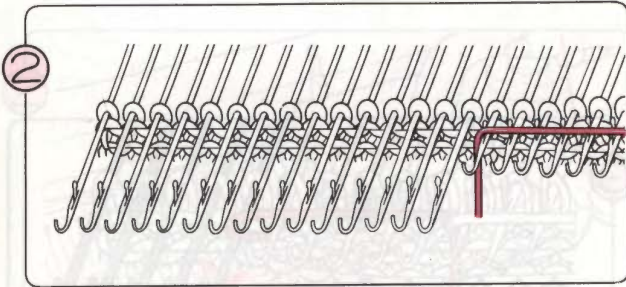

Lay the yarns for the Intarsia pattern and knit one row.

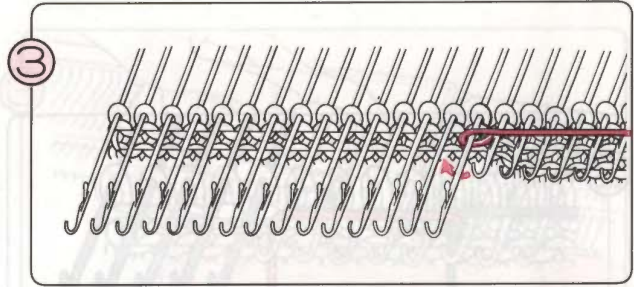

Wrap the yarn under the stem of the first needle in E position as shown, then lay the yarns for the Intarsia pattern. Knit one row.

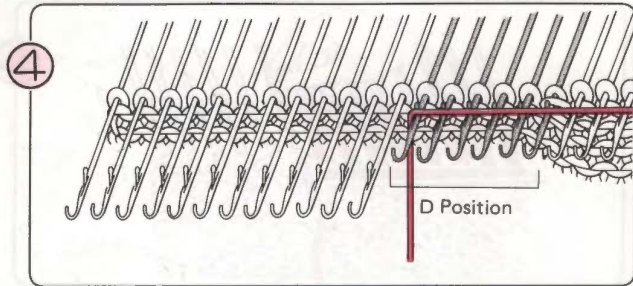

Bring the needles to be increased from E to D position and lay the yarns for the Intarsia pattern. Knit one row.

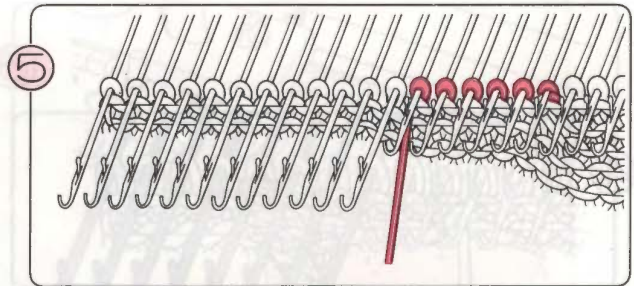

Continue to bring the needles to be increased from E to D position and repeat Steps ③ – ④ .

## HOW TO SHAPE A ROUND NECKLINE

### ● USING THE HOLDING CAM LEVER

● **STOCKING STITCH AND PLATING**

- The following example begins with the yarn and K-Carriage at the left. Reverse the instructions (e.g. read left for right) if beginning with yarn and K-Carriage at the right.

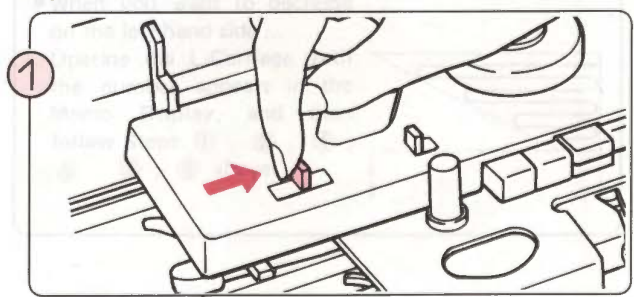
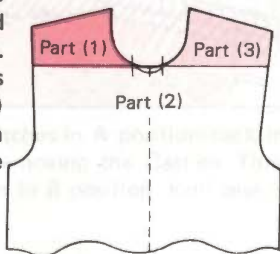

On the K-Carriage, set the Holding Cam Lever to H.

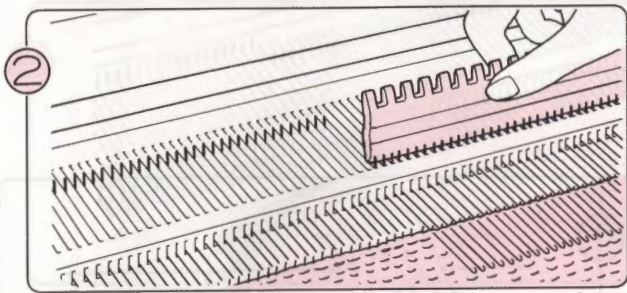

Using the flat side of the 1 x 1 Needle Pusher, bring the needles for Parts (2) and (3) forward to E position. These needles will not knit.

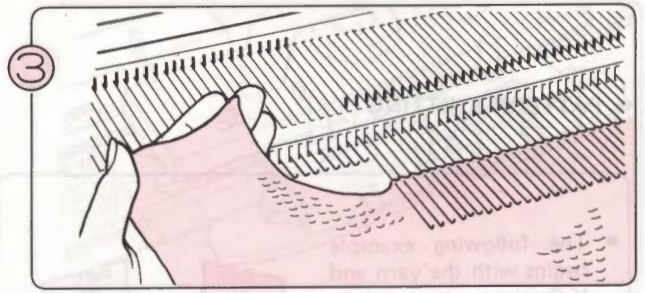

Knit Part (1) according to your pattern, and return needles to A position.

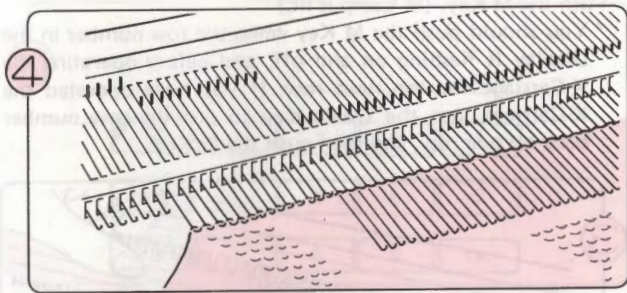

Bring needles from Part (2) to B position at the same time replacing the stitches into the needle hooks.

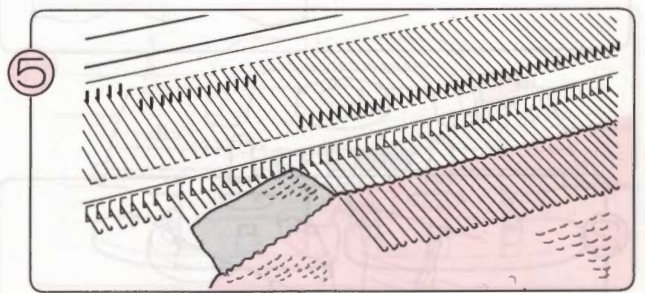

Waste knit Part (2) and remove this from machine. Return needles to A position.

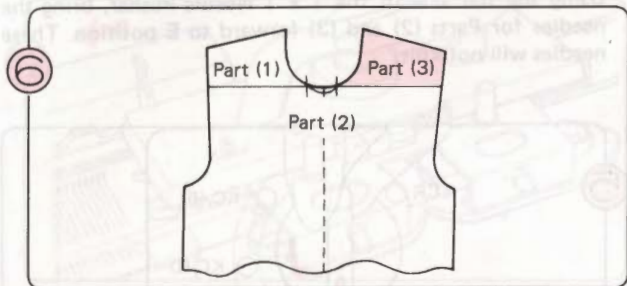

Now only the needles for Part (3) are left in E position.



Set the Holding Cam Lever on the K-Carriage to N.

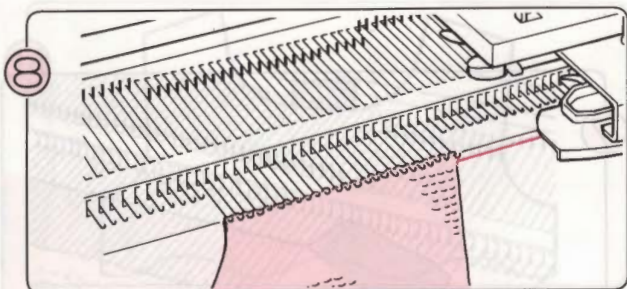

Knit Part (3) according to your pattern.

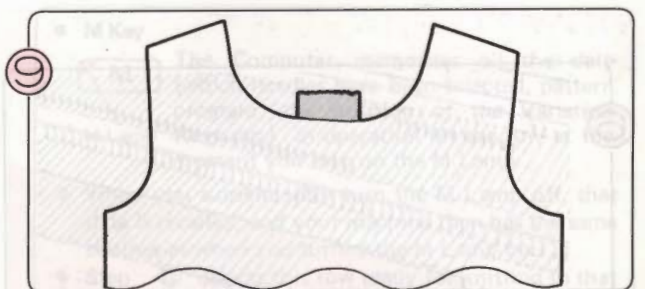

The neckline shaping has now been completed.

● PATTERN KNITTING

- The following example begins with the yarn and K-Carriage at the left. Reverse the instructions (e.g. read left for right) if beginning with yarn and K-Carriage at the right.

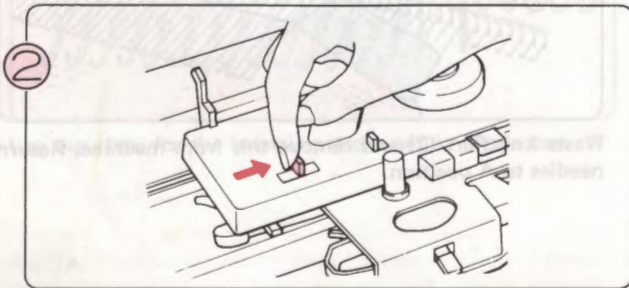
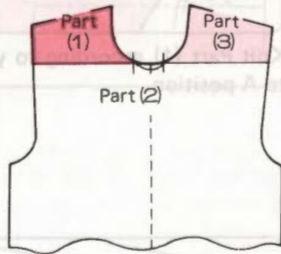

On the K-Carriage, set the Holding Cam Lever to H.

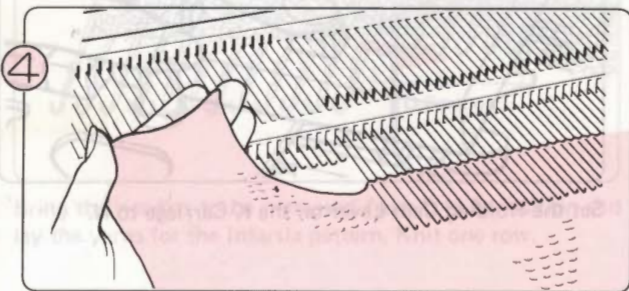

Knit Part (1) according to your pattern, and return needles to A position.

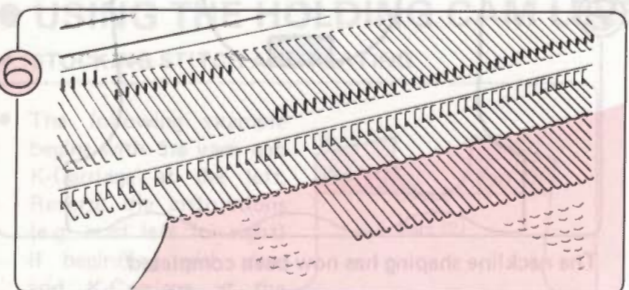

Bring needles from Part (2) to B position at the same time replacing the stitches into the needle hooks.

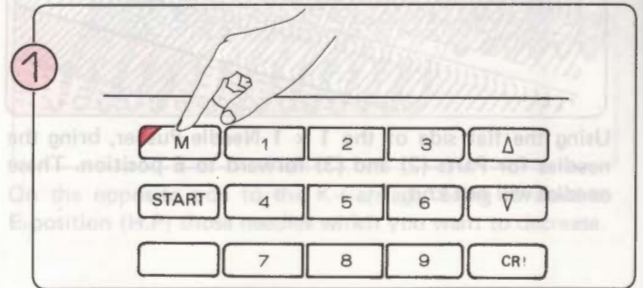

Push the M Key. (M Lamp is lit.)

\* You should push the M Key when the row number in the Display is flashing on and off, and before operating the K-Carriage for the next row. If you have operated the K-Carriage, use the Down Key to put the row number back by one row, and then push the M Key.

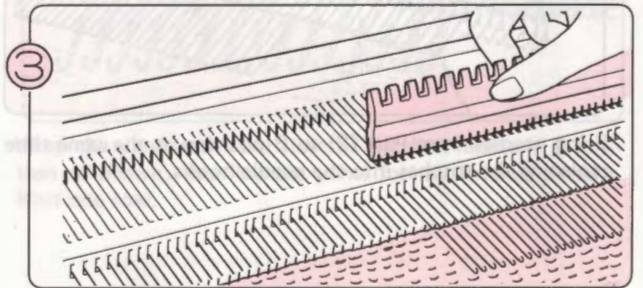

Using the flat side of the 1 x 1 Needle Pusher, bring the needles for Parts (2) and (3) forward to E position. These needles will not knit.

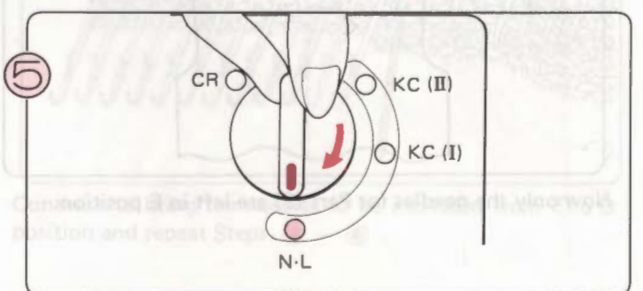

Set the Change Knob to N-L.

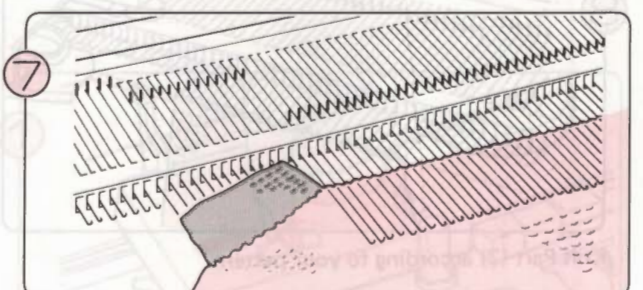

Waste knit Part (2) and remove this from machine. Return needles to A position.

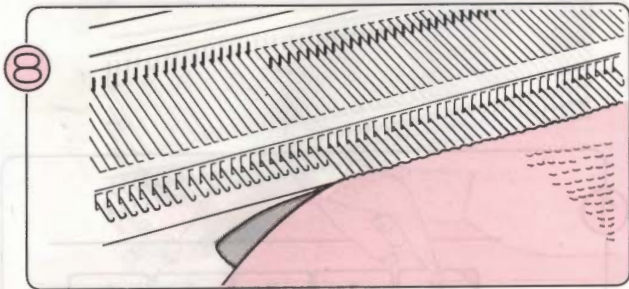

Now only the needles for Part (3) are left in E position. Bring these to B position the same as you did for Part (2).

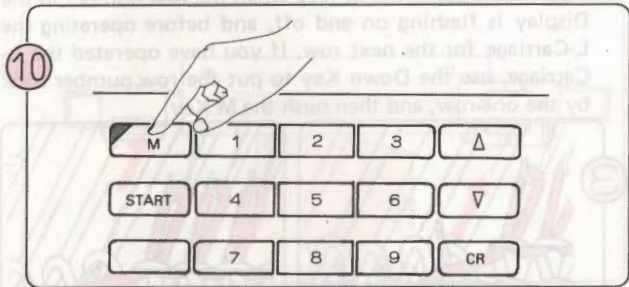

Push the M Key. (M Lamp light off.)

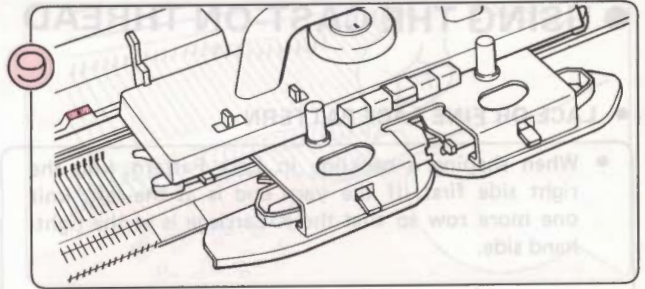

Place the K-Carriage outside the right Turn Mark.

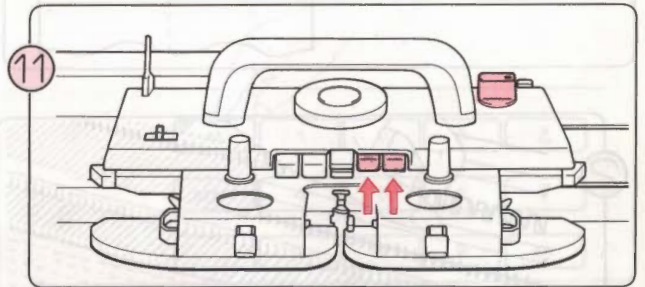

Push in both Part Buttons at the same time. Set the Change Knob to KC (I) or KC (II).

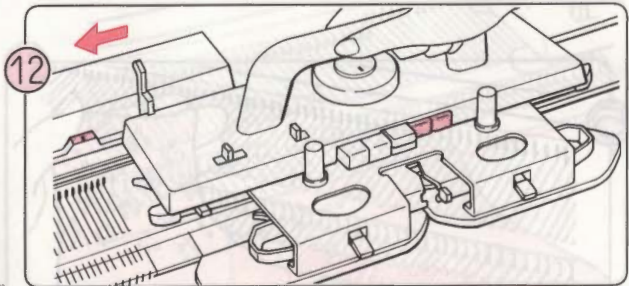

Move the K-Carriage from right to left across the right Turn Mark.

The needles are selected according to the pattern row memorised by the M Key.

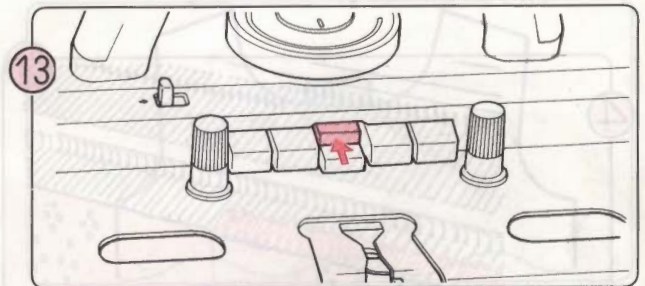

Push the Cam Buttons according to pattern. Knit part (3) according to your pattern.

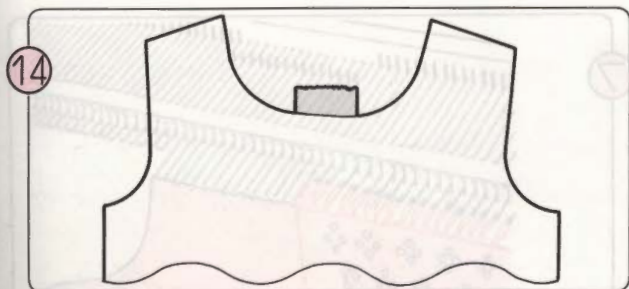

The neckline shaping has now been completed.

• M Key



The Computer memorises all the data (which needles have been selected, pattern program, the position of the Variation M Lamp Keys etc.) in operation on the row at the moment you turn on the M Lamp.

- When you subsequently turn the M Lamp off, that data is recalled, and your machine then has the same settings as when you turned the M Lamp on.
- Step 12 selects this row ready for knitting so that you rejoin the pattern where you left it at Step 1.
- When the M Key is in operation, the information being memorised can be deleted if you decide you won't need it. To cancel the M Key memory, push the C Key and the M Lamp will go off.



## ● USING THE CAST-ON THREAD

### ● LACE OR FINE LACE PATTERN

- When shaping a neckline in Lace Pattern, knit the right side first. If the yarn end is at the left, knit one more row so that the K-Carriage is at the right-hand side.

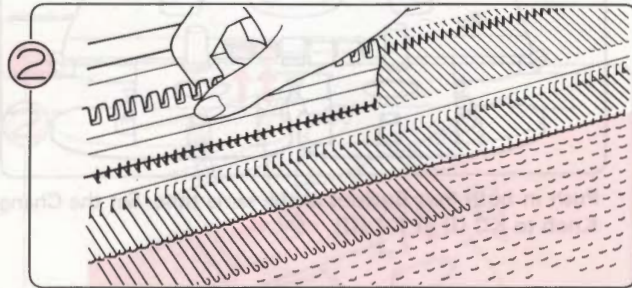
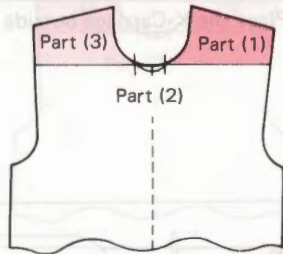

Using the flat side of the 1 x 1 Needle Pusher, bring the needles for Parts (2) and (3) forward to E position.

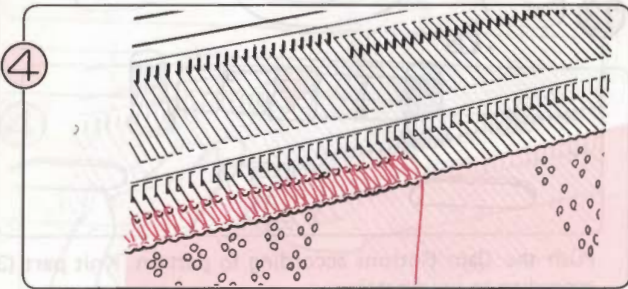

These needles in A position will not knit.

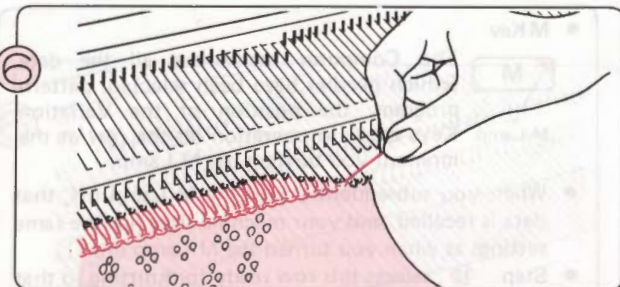

Bring needles from Part (2) from A to B position at the same time replacing the stitches into the needle hooks and removing the Cast-on Thread.

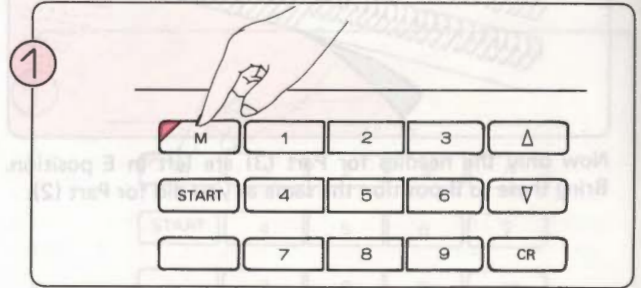

Push the M Key. (M Lamp is lit.)

\* You should push the M Key when the row number in the Display is flashing on and off, and before operating the L-Carriage for the next row. If you have operated the L-Carriage, use the Down Key to put the row number back by the one row, and then push the M Key.

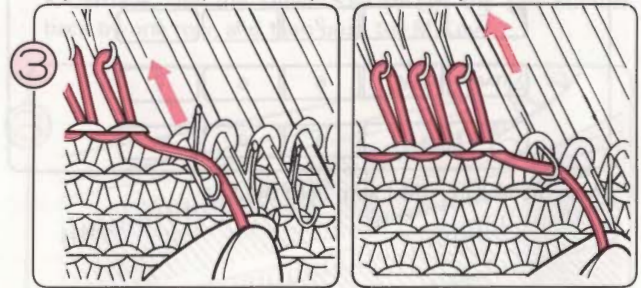

Hang the Cast-on Thread over the hooks of the needles in E position, and knit them back to A position by hand.

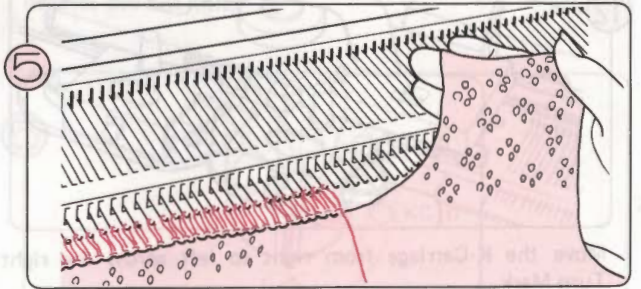

Knit Part (1) according to your pattern using both L and K Carriages, and return empty needles to A position.

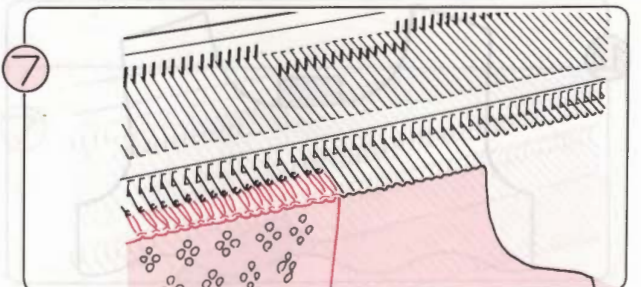

The needles for Part (3) are still left in A position.

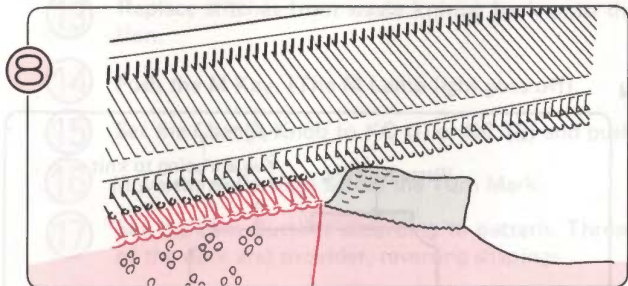

8 Knit Part (2) ending with waste knitting and remove this from machine. Return needles to A position.

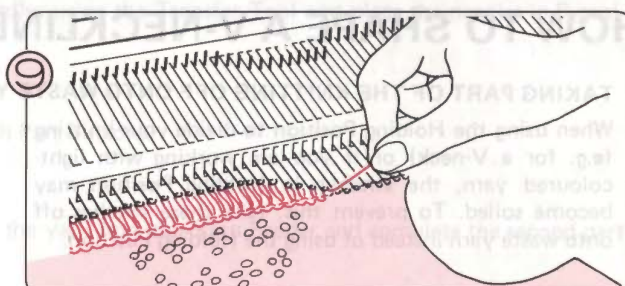

9 Now only the needles for Part (3) are left in A position. Bring these to B position the same as you did for Part (2).

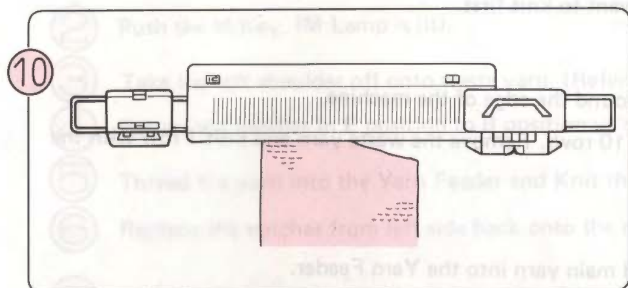

10 Place the K-Carriage outside the right Turn Mark and the L-Carriage outside the left Turn Mark.

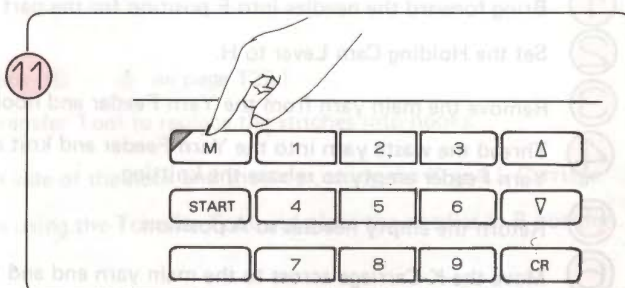

11 Push the M Key. (M Lamp light off).

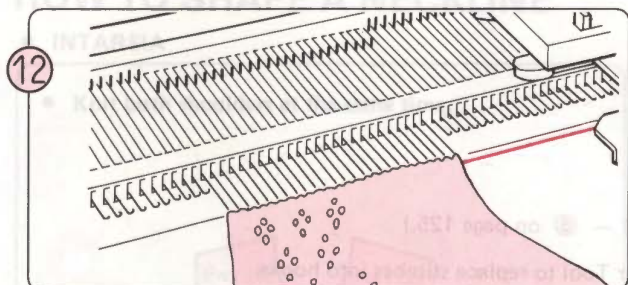

12 Knit Part (3) according to your pattern, using the K and L Carriages.

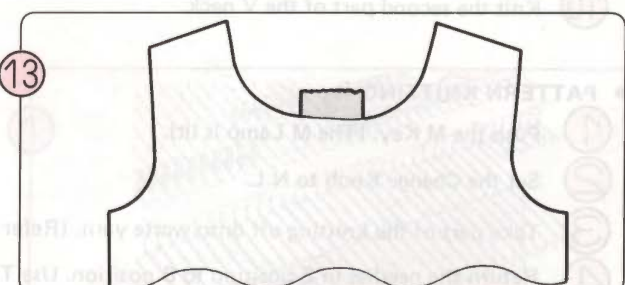

13 The neckline shaping has now been completed.

# HOW TO SHAPE A V-NECKLINE

## ● TAKING PART OF THE KNITTING OFF ONTO WASTE YARN

- When using the Holding Position to divide your knitting (e.g. for a V-neck) or if you are working with light-coloured yarn, the stitches in Holding Position may become soiled. To prevent this, take these stitches off onto waste yarn instead of using the Holding Position.



## ● STOCKING STITCH AND PLATING

- ① Bring forward the needles into E position for the part you want to knit first.
- ② Set the Holding Cam Lever to H.
- ③ Remove the main yarn from the Yarn Feeder and hook it around the edge of the machine.
- ④ Thread the waste yarn into the Yarn Feeder and knit about 10 rows. Remove the waste yarn and knit 1 row with the Yarn Feeder empty to release the knitting.
- ⑤ Return the empty needles to A position.
- ⑥ Move the K-Carriage across to the main yarn end and thread main yarn into the Yarn Feeder.
- ⑦ Set the Holding Cam Lever to N.
- ⑧ Knit the first part of the V neck.
- ⑨ Replace stitches from waste knitting back onto the needles using a Transfer Tool, and put needles in B position.
- ⑩ Knit the second part of the V neck.

## ● PATTERN KNITTING

- ① Push the M Key. (The M Lamp is lit).
- ② Set the Change Knob to N.L.
- ③ Take part of the knitting off onto waste yarn. (Refer to ① – ⑤ on page 125.)
- ④ Return the needles in E position to B position. Use Transfer Tool to replace stitches into hooks.
- ⑤ Place the K-Carriage outside the Turn Mark at the opposite side to the yarn end.
- ⑥ Set the Change Knob to KC (I) or KC (II). Push both Part Buttons. Set the Holding Cam Lever to N.
- ⑦ Push the M Key. (The M Lamp light goes off).
- ⑧ Move the K-Carriage across the Turn Mark.
- ⑨ Push the M Key. (The M Lamp is lit).
- ⑩ Push the Cam Button according to the pattern.
- ⑪ Thread the main yarn into the Yarn Feeder and knit the first part of the neck and shoulder.
- ⑫ Set the Change Knob to N.L. Place the K-Carriage outside the Turn Mark at the opposite side to the first part of the neck and shoulder.

- 13 Replace stitches from waste knitting back onto the needles using the Transfer Tool and place the needles in B position.
- 14 Push the M Key. (The M Lamp light goes off).
- 15 Set the Change Knob to KC (I) or KC (II) and push both Part Buttons.
- 16 Move the K-Carriage across the Turn Mark.
- 17 Set the Cam Buttons according to pattern. Thread up the yarn into the Yarn Feeder and complete the second part of the neck and shoulder, reversing shapings.

#### • LACE AND FINE LACE PATTERN

- 1 When shaping a neckline in Lace Pattern knit the right side first. If the yarn end is at the left, knit one more row so that the K-Carriage is at the righthand side.
- 2 Push the M Key. (M Lamp is lit).
- 3 Take the left shoulder off onto waste yarn. (Refer to Steps 1 – 5 on page 125.)
- 4 Return the needles in E position to B position using a Transfer Tool to replace the stitches into hooks.
- 5 Thread the yarn into the Yarn Feeder and Knit the right side of the neck and shoulder, using the K and L Carriage.
- 6 Replace the stitches from left side back onto the needles using the Transfer Tool and place the needles in B position.
- 7 Push the M Key. (The M Lamp light goes off).
- 8 Knit the left side of the neck and shoulder according to your pattern, using the K and L Carriages.

## HOW TO SHAPE A NECKLINE

#### • INTARSIA

- Knit both shoulders at the same time.

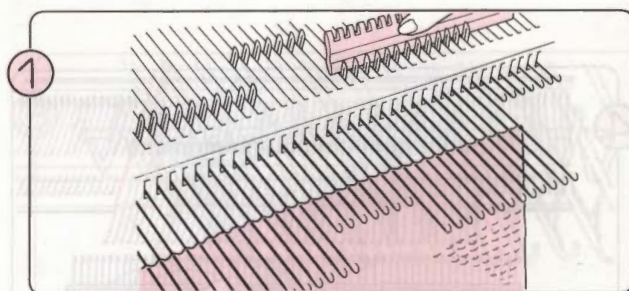
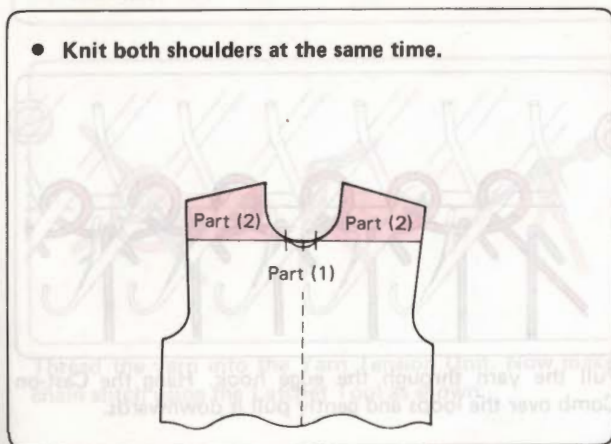

1 Bring the two sets of needles for Part (2) into E position.

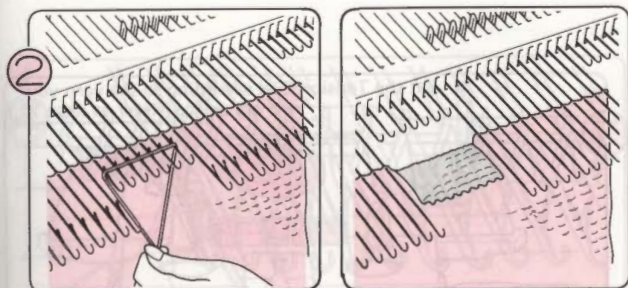

2 Waste knit the stitches for Part (1) only and return needles to A position.

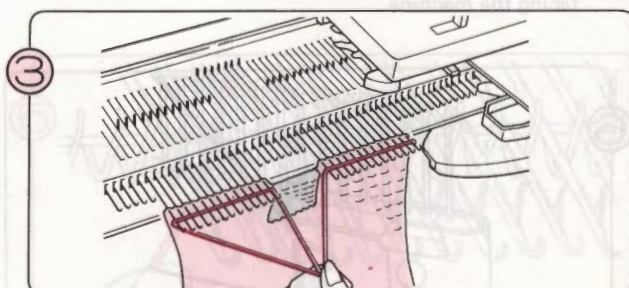

3 Return the Part (2) needles from E to D position and knit both shoulders according to your pattern.

# HOW TO CAST ON WITH A FINISHED EDGE (CLOSED EDGE CAST ON) 'E' WRAP METHOD

- With this method you will achieve a thin, elastic edge so it is suitable for any type of knitting.

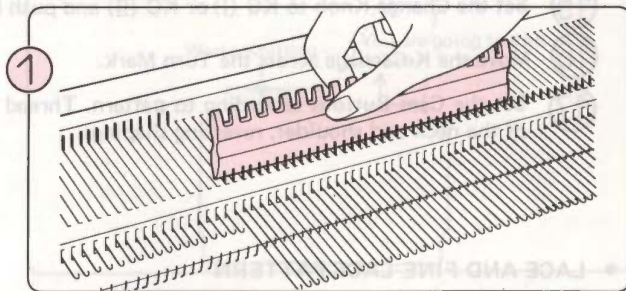
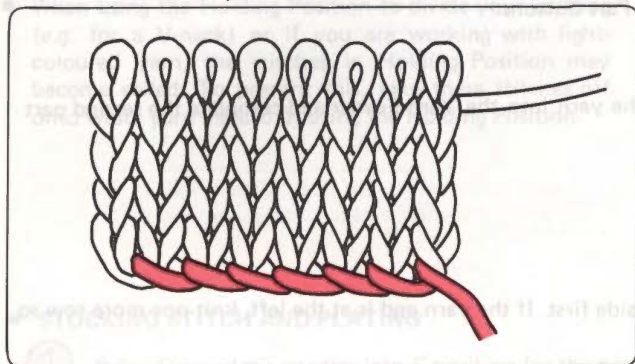

1 Place the K-Carriage at the right. Using the flat side of the 1/1 Needle Pusher, bring the needles forward to E position.

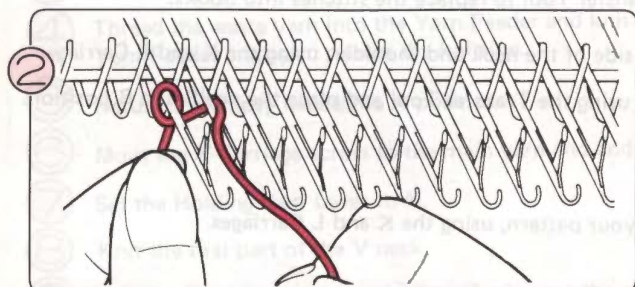

2 Beginning at the left, and working from left to right, wind the yarn around the needles in an anticlockwise direction. Do not wind the yarn too tight.

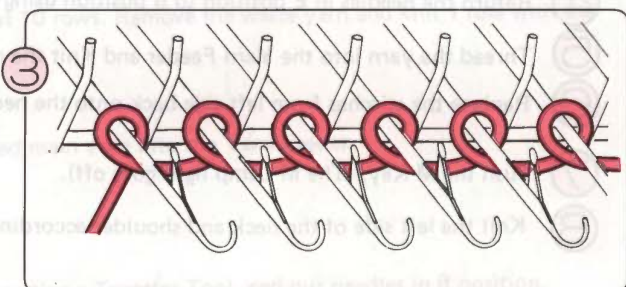

3 The loops should be behind the latches as shown.

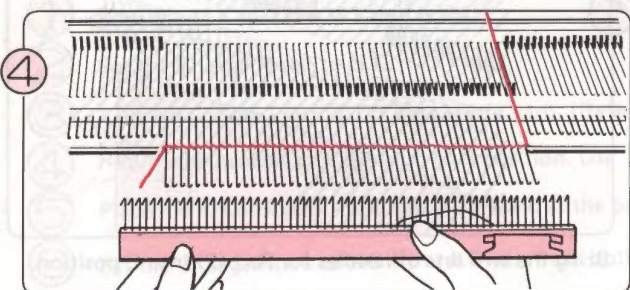

4 (1) Take the Cast-on Comb out of the Case and choose the length according to the number of needles. (Refer to page 13.)

(2) Hold the Cast-on Comb as shown with the hooks facing the machine.

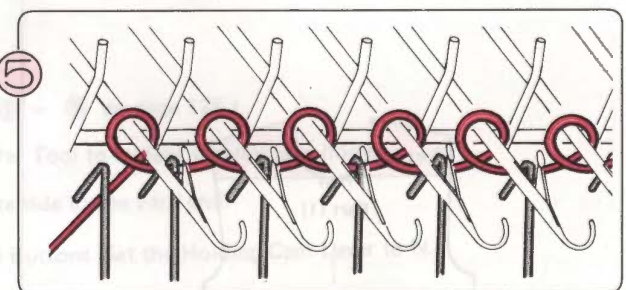

5 Pull the yarn through the edge hook. Hang the Cast-on Comb over the loops and gently pull it downwards.

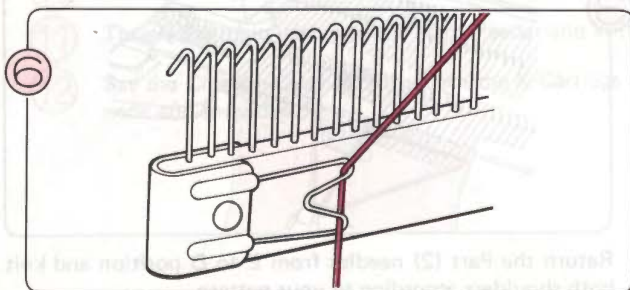

6 Hook the loose yarn end under the Yarn Clip from the front.

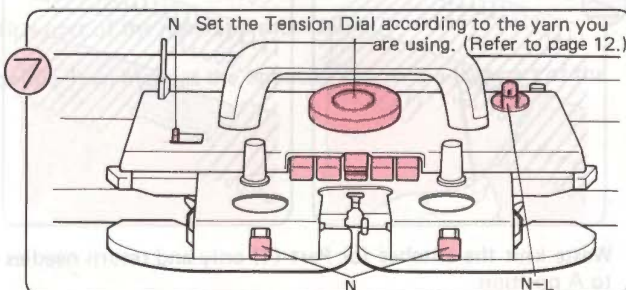

7 Set the K-Carriage as shown above.

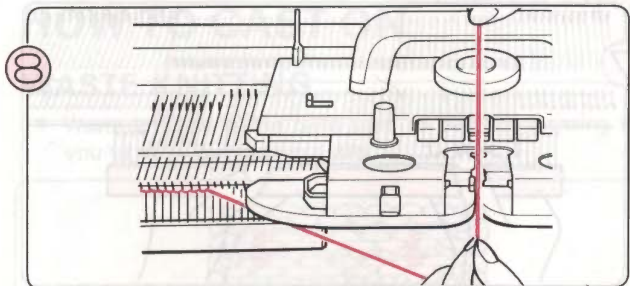

8 Thread the yarn into Yarn Feeder "A" (Refer to Steps 7 — 8 on page 16).

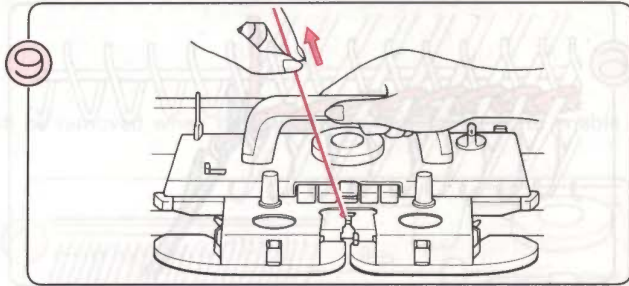

9 Move the K-Carriage to the left, holding the yarn as shown so that no loops are formed.

## USING THE LATCHET TOOL (CHAIN STITCH CAST ON)

- With this method you will achieve a firm edge which is not very elastic.

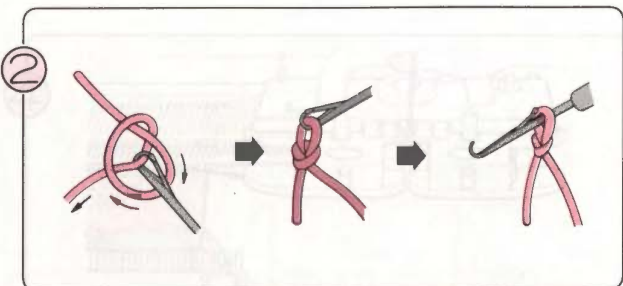
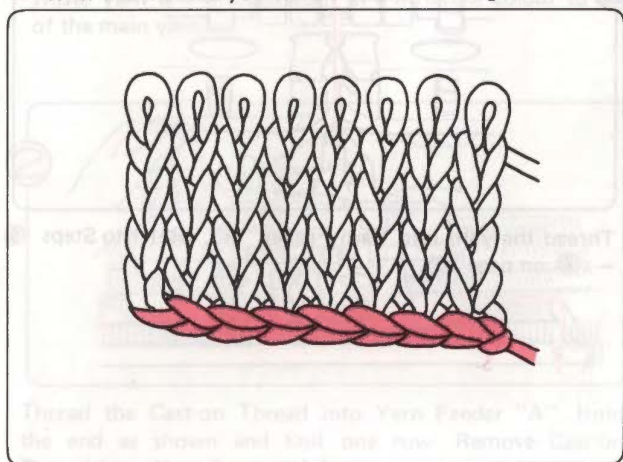

3 Thread the yarn into the Yarn Tension Unit. Now make a chain stitch using the Latchet Tool as shown.

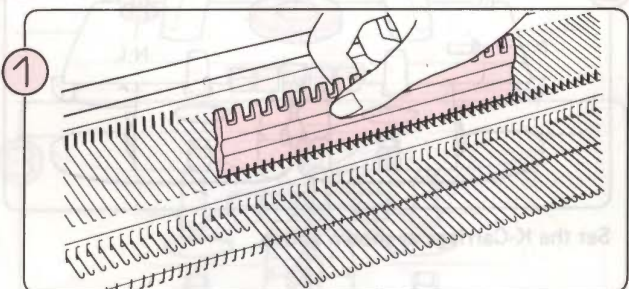

1 Place the K-Carriage at the right. Using the flat side of the 1/1 Needle Pusher, bring the needles forward to E position.

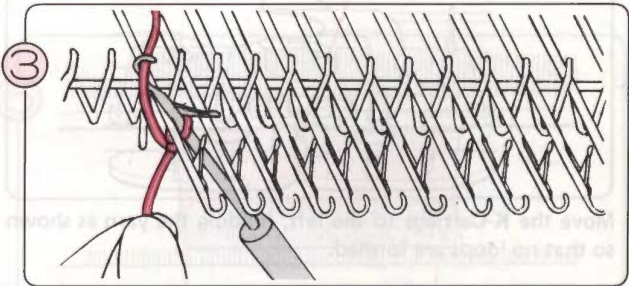

2 With the loop behind the latch, insert the Latchet Tool between the first and second needles on the left. Catch the yarn with the Latchet Tool.

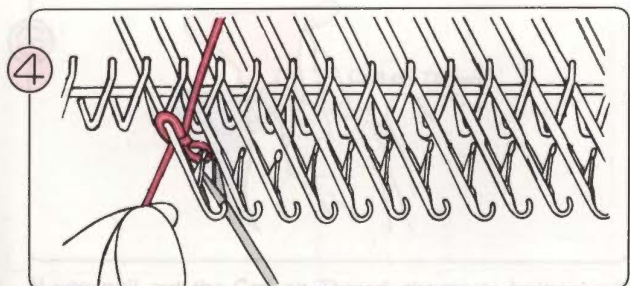

4 Keeping the yarn in the hook of the Latchet Tool, pull the yarn down through the chain loop, and slip the loop off the Latchet Tool. This makes one stitch.

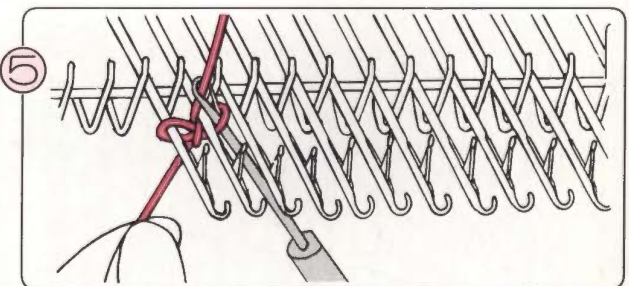

5 Repeat this across the needles until you reach the last needle.

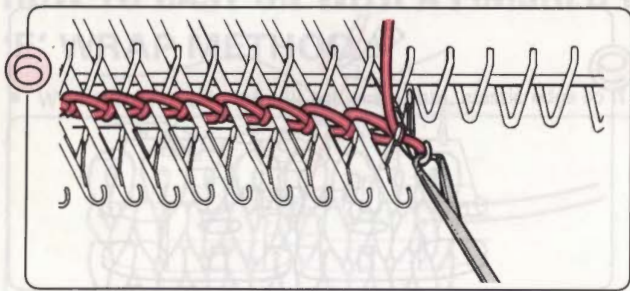

When you get to the last needle, transfer the loop from the Latchet Tool into the needle hook.

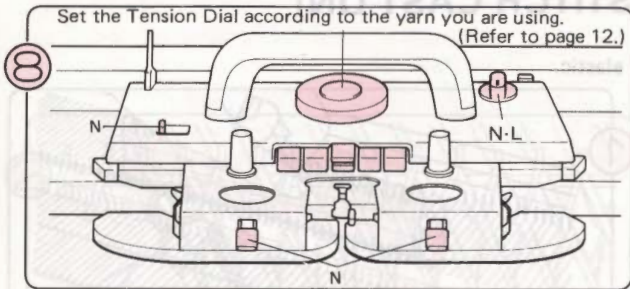

Set the Tension Dial according to the yarn you are using. (Refer to page 12.)  
Set the K-Carriage as shown above.

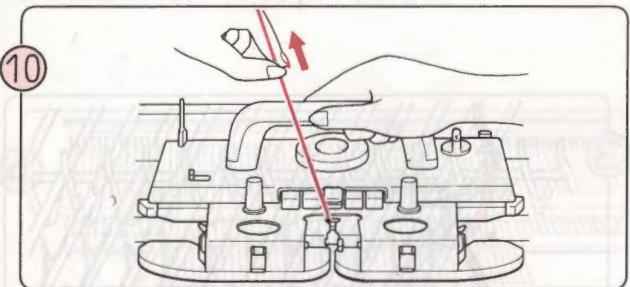

Move the K-Carriage to the left, holding the yarn as shown so that no loops are formed.

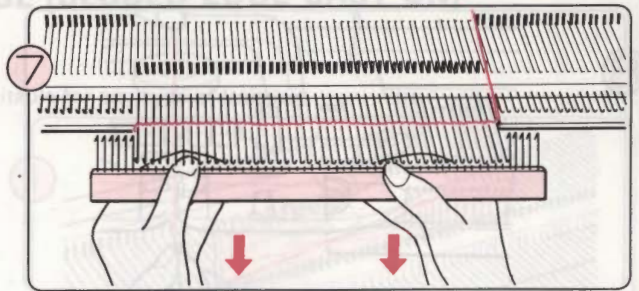

- (1) Take the Cast-on Comb out of the Case and choose the length according to the number of needles. (Refer to page 13).
- (2) Hold the Cast-on Comb as shown with the hooks facing the machine. Hang the Cast-on Comb over the loops and gently pull it downwards.

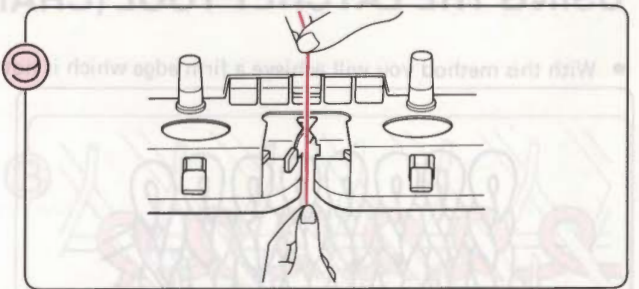

Thread the yarn into Yarn Feeder "A". (Refer to Steps 5 - 7 on page 16).

# HOW TO CAST ON WASTE KNITTING

- Waste knitting is the term used to describe knitting that will be removed when the garment is completed, or to enable you to carry out the next step.

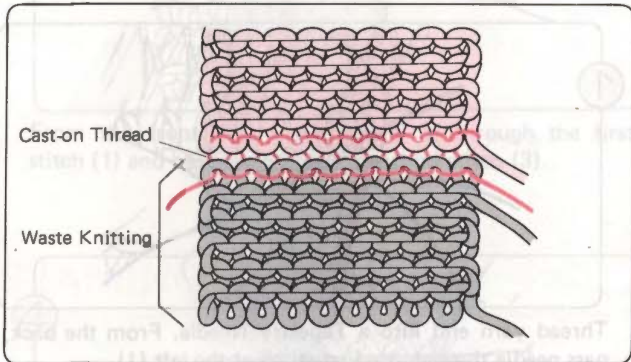

Waste yarn is a smooth yarn in a different colour to that of the main yarn.

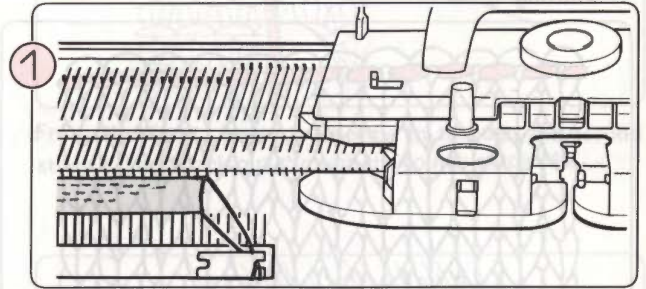

1 Knit 10 rows in stocking stitch using waste yarn ending with the K-Carriage at the right of the needlebed. Remove waste yarn from Yarn Feeder and cut the yarn.

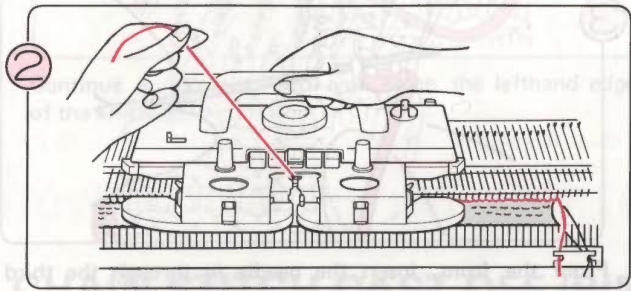

2 Thread the Cast-on Thread into Yarn Feeder "A". Hold the end as shown and knit one row. Remove Cast-on Thread from Yarn Feeder "A".

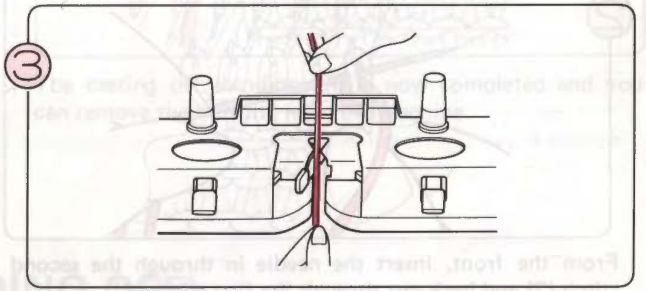

3 Thread the main yarn into Yarn Feeder "A".

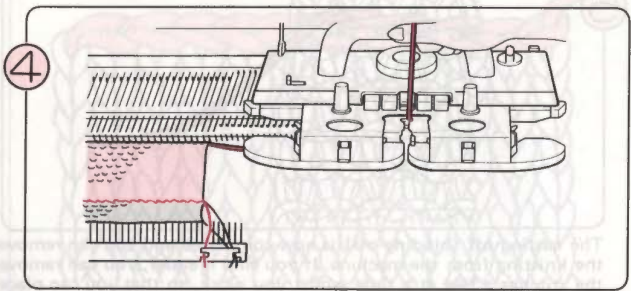

4 Knit several rows.

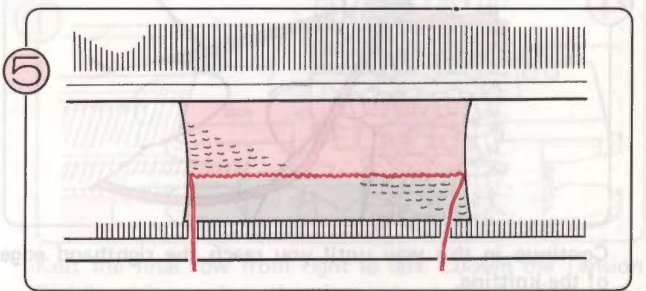

5 One row has been knitted with the Cast-on Thread and this separates the waste knitting from the main knitting.

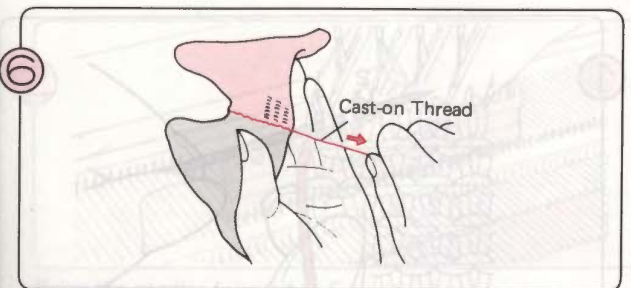

6 If you pull out the Cast-on Thread, the waste knitting will drop away.

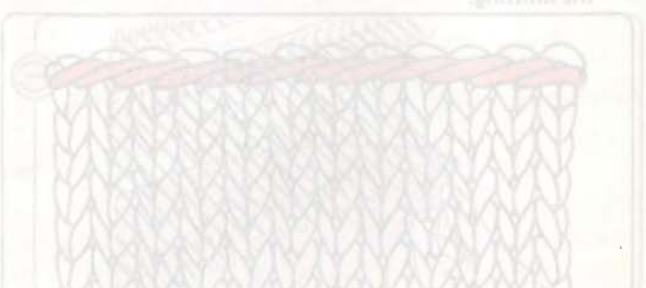



## BACKSTITCH CASTING OFF (BINDING OFF) USING THE TAPESTRY NEEDLE (ENDING WITH K-CARRIAGE ON THE LEFT)

- With this method you will achieve a thin, elastic edge so it is suitable for any type of knitting.
- The yarn is on the lefthand side. Take yarn out of the Yarn Feeder and cut it leaving a length three times the width of the knitting.

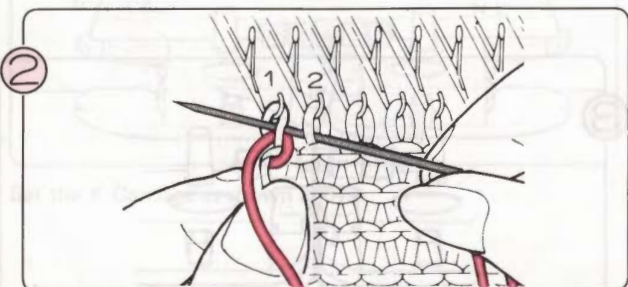
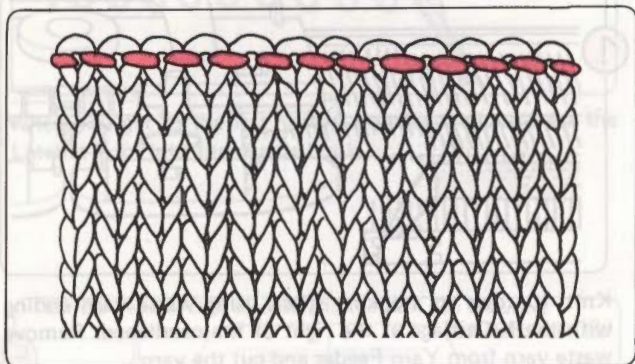

From the front, insert the needle in through the second stitch (2) and back out through the first stitch (1).

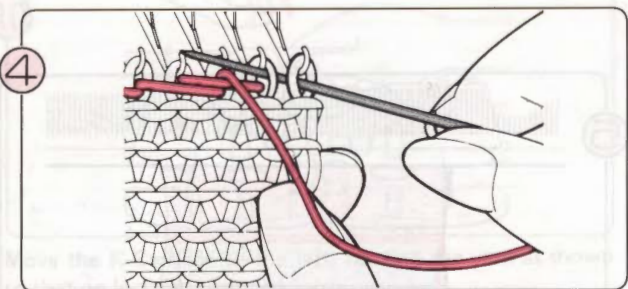

Continue in this way until you reach the righthand edge of the knitting.

## USING THE TAPESTRY NEEDLE (ENDING WITH K-CARRIAGE ON THE RIGHT)

- With this method you will achieve a thin, elastic edge so it is suitable for any type of knitting.
- The yarn is on the righthand side. Take yarn out of the Yarn Feeder and cut it leaving a length three times the width of the knitting.

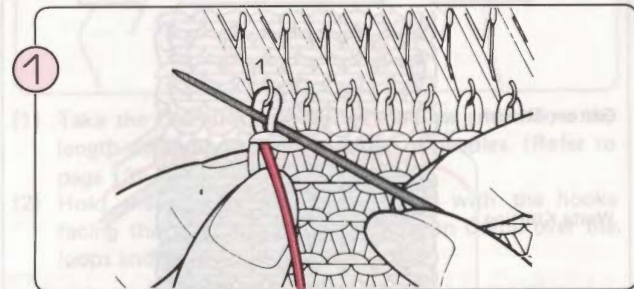
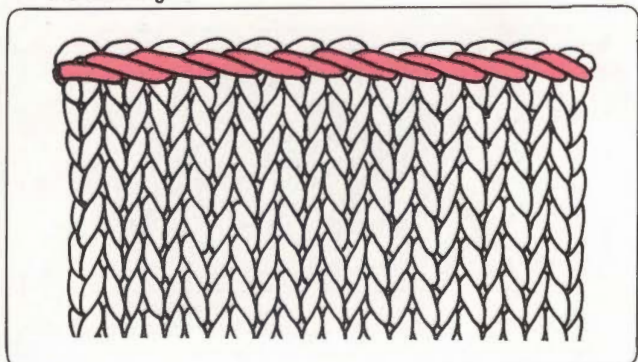

Thread yarn end into a Tapestry Needle. From the back, pass needle through the first stitch at the left (1).

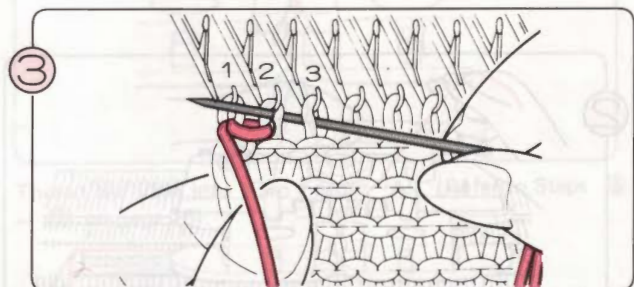

From the front, insert the needle in through the third stitch (3) and back out through the second stitch (2).

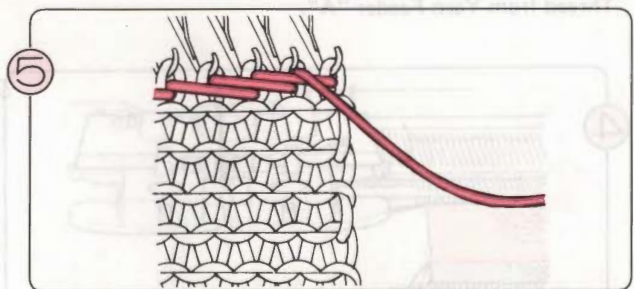

The casting off (binding off) is now completed and you can remove the knitting from the machine. If you find it easier, you can remove the stitches a few at a time whilst you work, so that you can place your left hand behind the knitting.

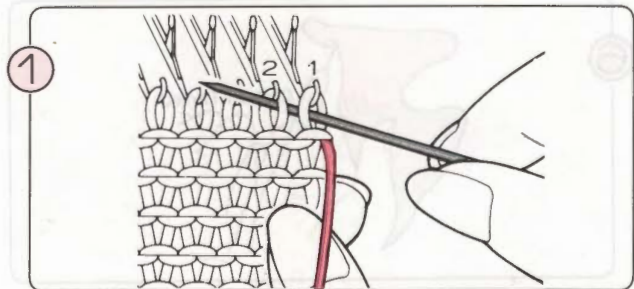

Thread yarn end into a Tapestry Needle. From the front, pass needle through the first stitch at the right (1), and back out through the second stitch (2).

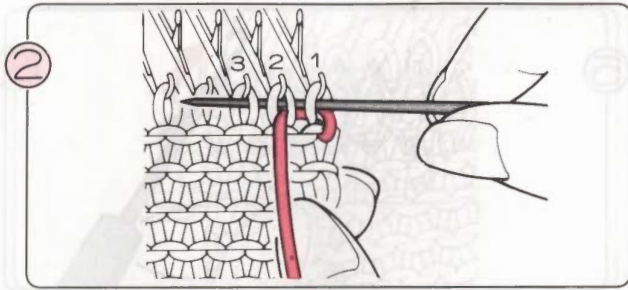

From the front, insert the needle in through the first stitch (1) and back out through the third stitch (3).

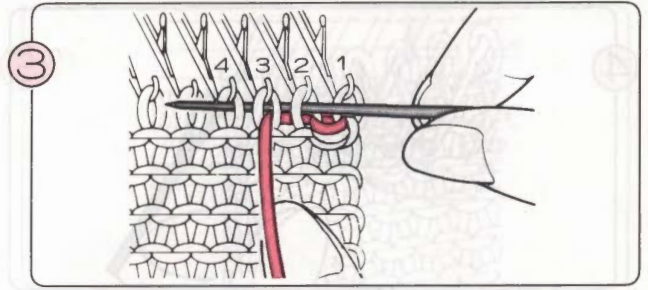

From the front, insert the needle in through the second stitch (2) and back out through the fourth stitch (4).

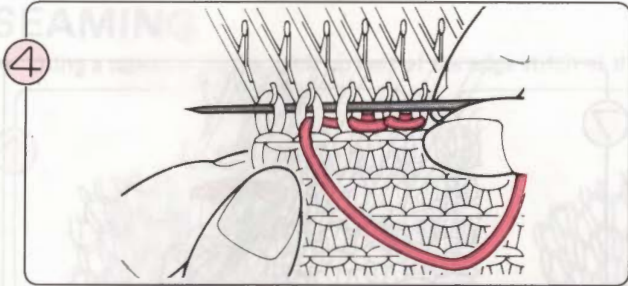

Continue in this way until you reach the lefthand edge of the knitting.

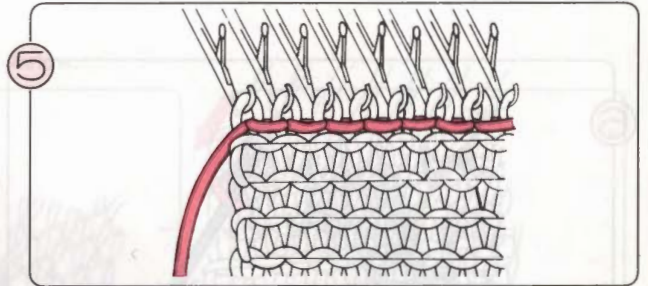

The casting off (binding off) is now completed and you can remove the knitting from the machine.

## CHAIN STITCH CAST OFF (BINDING OFF) USING THE LATCHET TOOL

- With this method you will achieve a firm edge which is not very elastic.

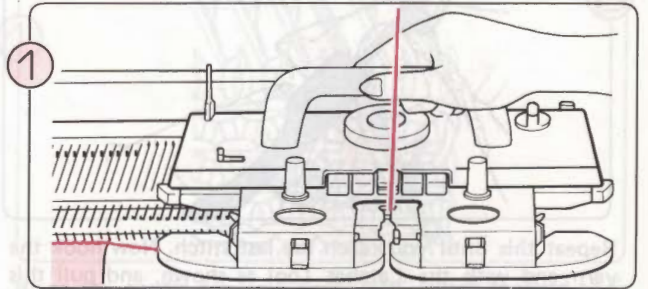
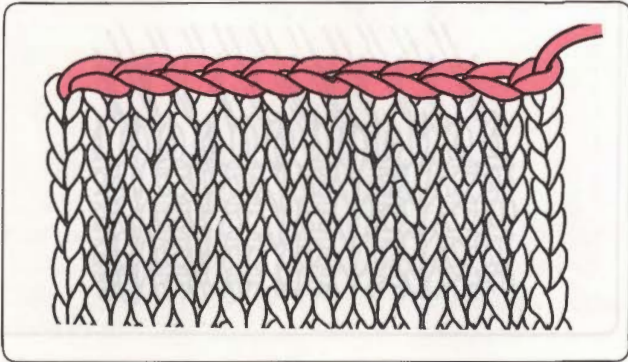

Knit the final row from right to left. Loosen the Tension Dial for this row (e.g. if main tension is say 4 – 6, knit the final row at tension 9 – 10).

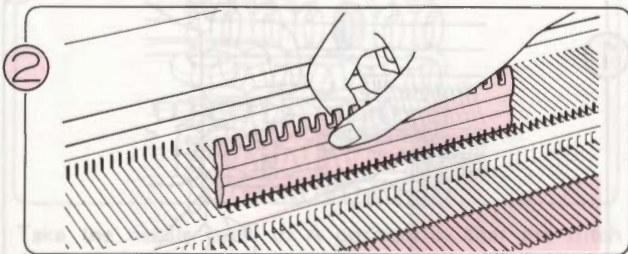

Bring the needles forward to E position.

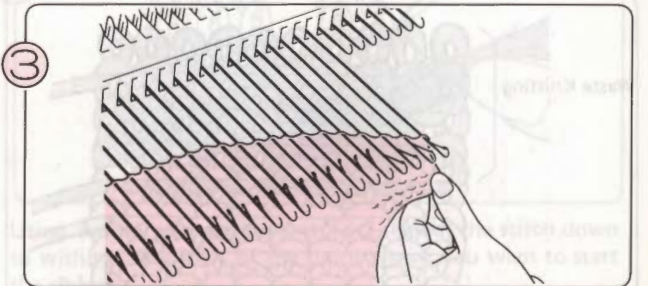

Gently bring the knitting towards you, taking care not to drop any stitches.

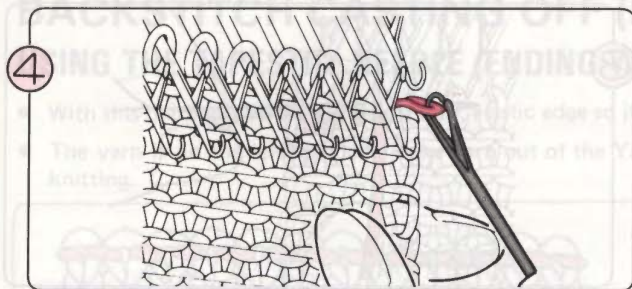

4 Beginning at the righthand edge, hook the first stitch onto the Latchet Tool.

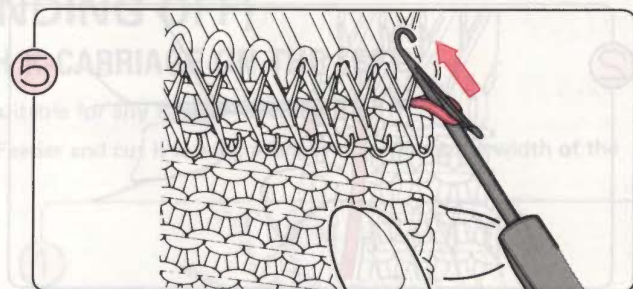

5 Put the stitch behind the latch of the Latchet Tool.

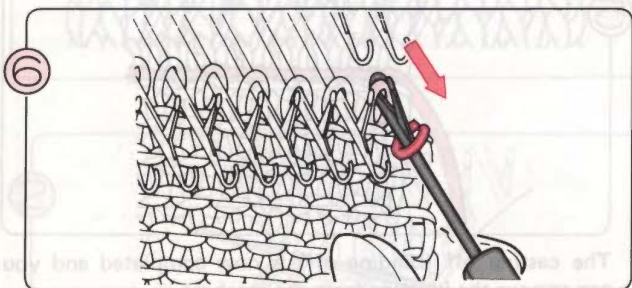

6 Now hook the second stitch with the Latchet Tool, keeping this stitch in the hook.

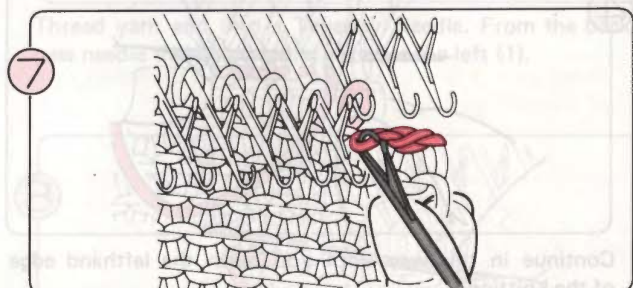

7 Draw the second stitch through the first stitch, letting the first stitch slip off over the hook.  
\*Take care not to drop any of the other stitches from off the needles whilst you work.

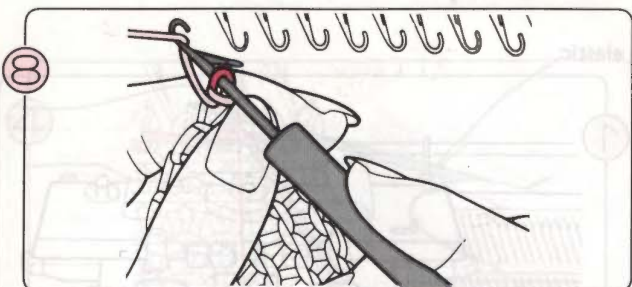

8 Repeat this until you reach the last stitch. Now hook the yarn end with the Latchet Tool as shown, and pull this through the last stitch.

## WASTE KNITTING

You can remove your knitting from the machine with rows of waste knitting. Use this when you want to return the stitches to the needles again e.g. to knit a cuff.

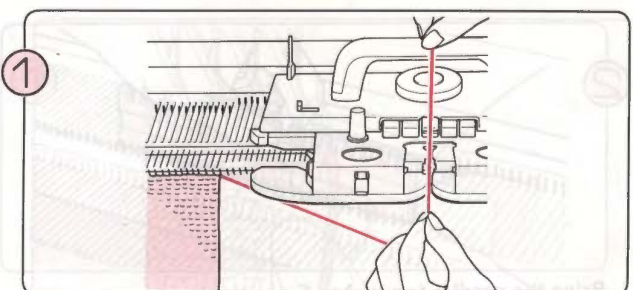
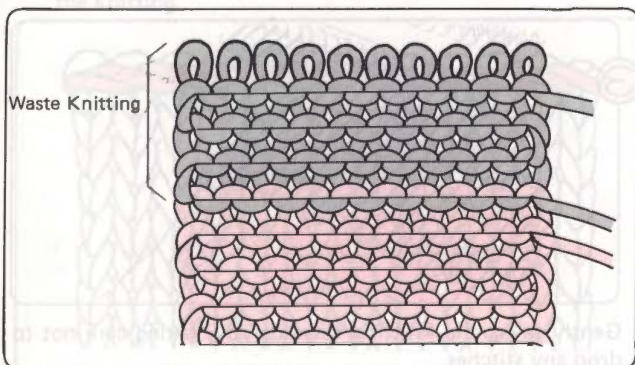

1 Take the yarn out of Yarn Feeder "A".

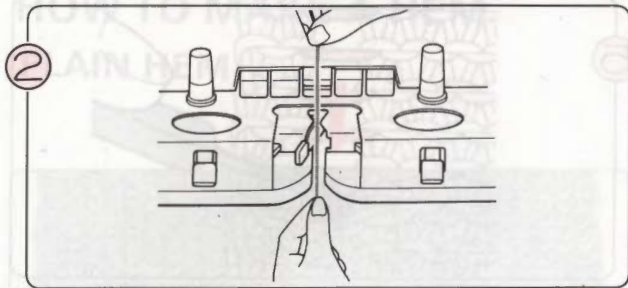

Thread the waste yarn into Yarn Feeder "A".

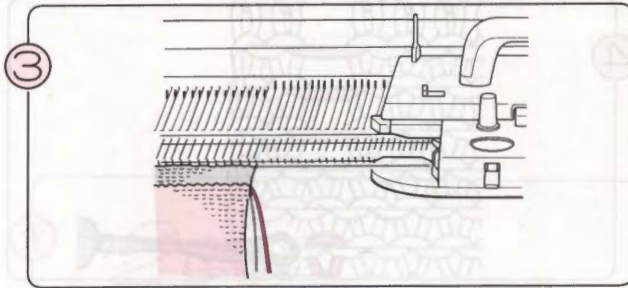

After knitting several rows with waste yarn, remove the knitting by passing the empty carriage across the stitches.

## SEAMING

- Using a tapestry needle, pick up half of the edge stitch as shown below.

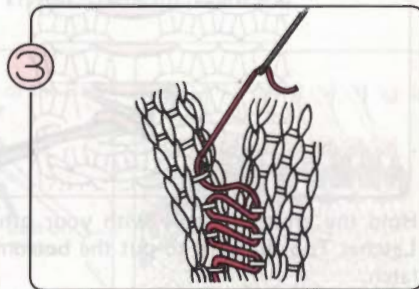
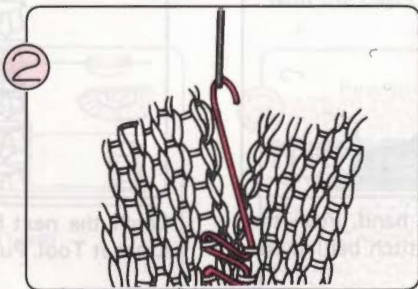
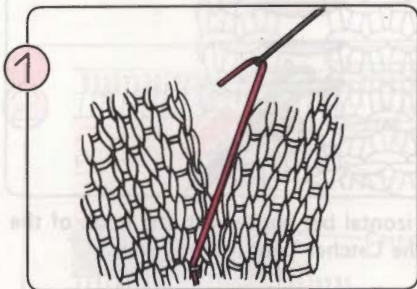

## HOW TO USE THE LATCHET TOOL

Use the Latchet Tool to pick up dropped stitches or to reform stitches e.g. plain stitches into purl stitches to make ribbing.

## MAKING RIB BY HAND

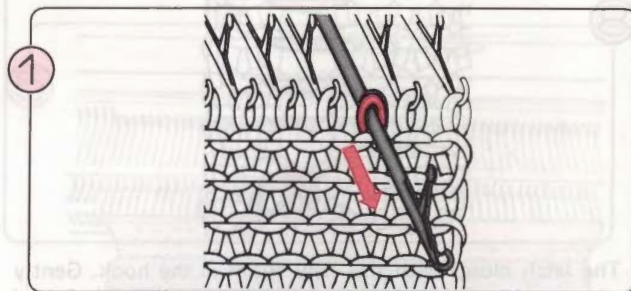
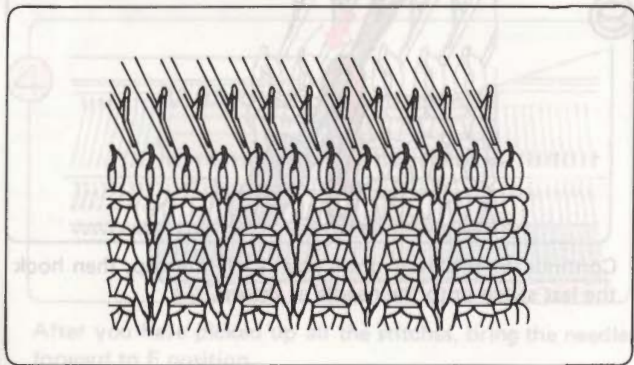

Bring the needle for your first "purl" stitch forward to E position by hand.

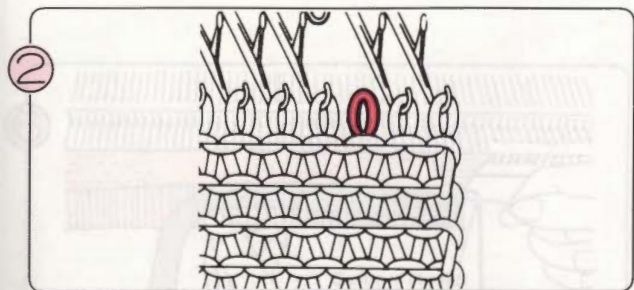

Take the needle back to A position so that the stitch drops off the needle.

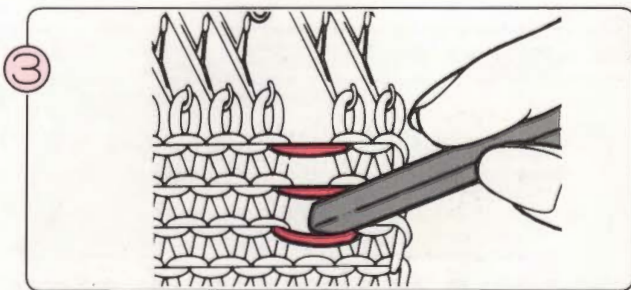

Using the tip of your Latchet Tool, ladder the stitch down to within a few rows of the point where you want to start the ribbing.

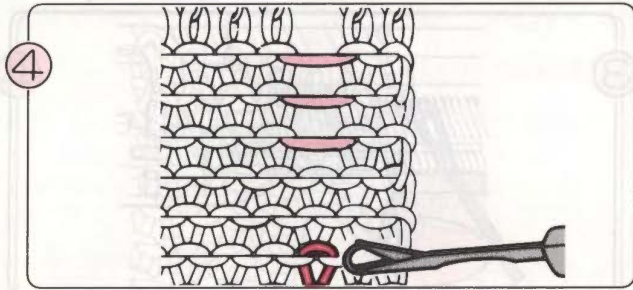

4 With the Latchet Tool hook the bottom stitch where the ribbing will begin.

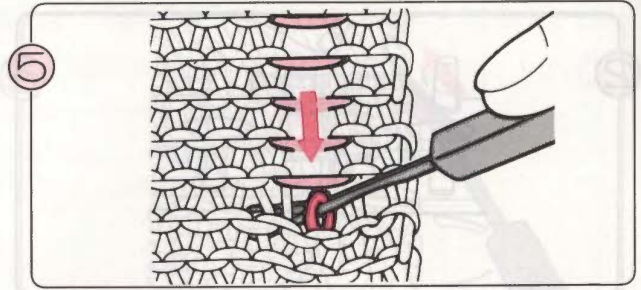

5 Push down with the Latchet Tool so that the last few stitches drop.

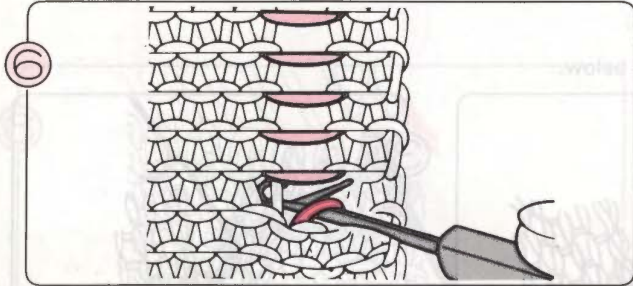

6 Hold the knitting firmly with your other hand. Push the Latchet Tool forward to put the bottom stitch behind the latch.

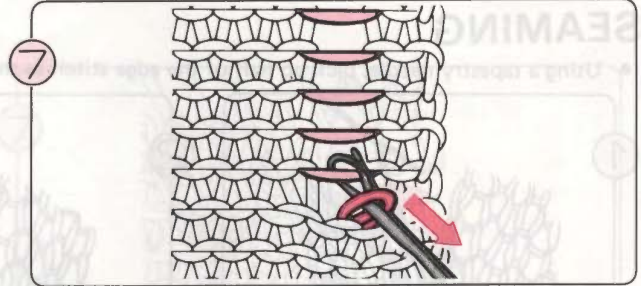

7 Catch the next horizontal bar above with the hook of the Latchet Tool. Pull the Latchet Tool towards you.

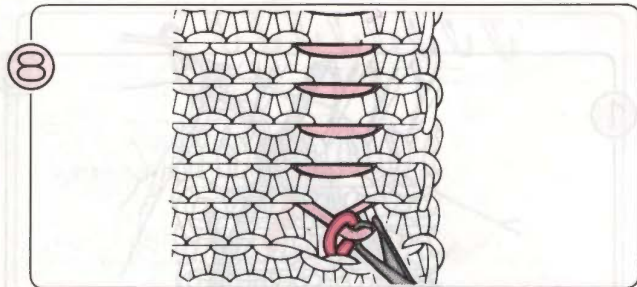

8 The latch closes with this new stitch in the hook. Gently slip the old stitch off the end of the Latchet Tool. A purl stitch has been formed.

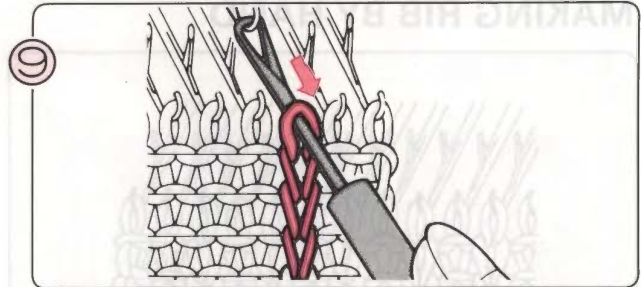

9 Continue in this way until you reach the top, then hook the last stitch onto the needle as shown.

## WASTE KNITTING



10



11

# HOW TO MAKE A HEM

## PLAIN HEM

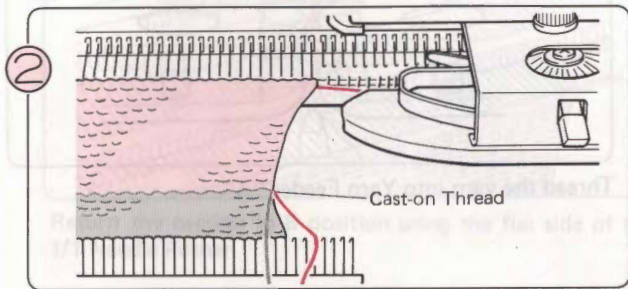
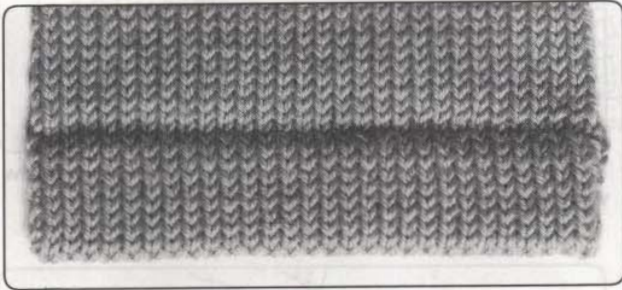

Working in stocking stitch, knit the number of rows required for double the depth of the hem (e.g. if hem is to be folded under 2.5 cms (1") then knit 5 cms (2")).

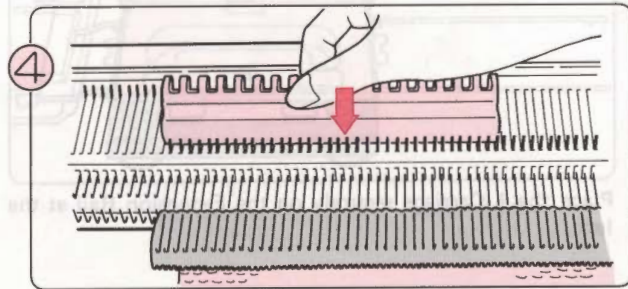

After you have picked up all the stitches, bring the needles forward to E position.

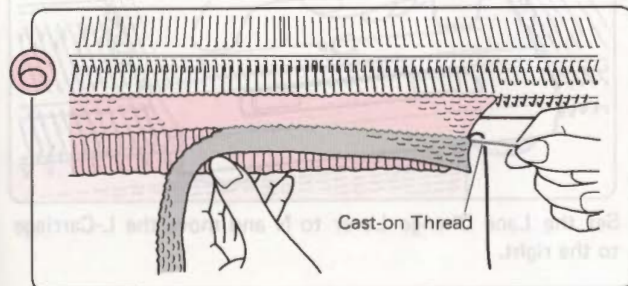

When you have knitted several rows you can pull out the Cast-on Thread. The waste knitting will fall away.

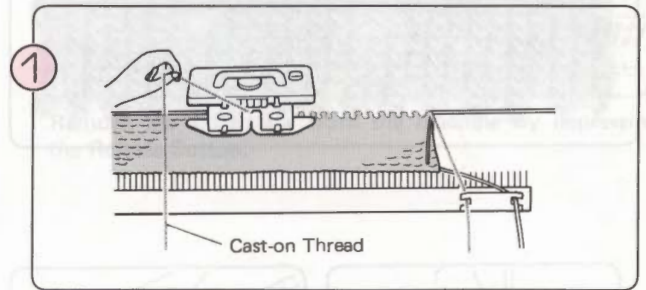

Knit several rows with waste yarn and then knit one row with the Cast-on Thread. (Refer to page 130.)

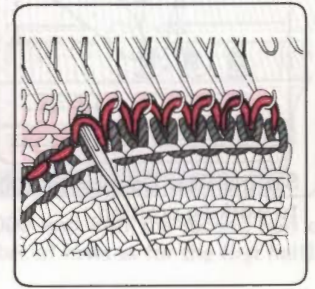
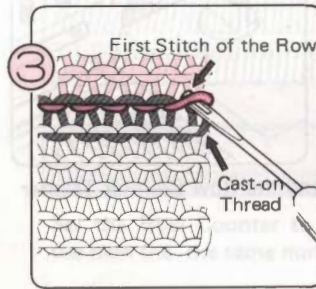

Using your Transfer Tool, pick up the first stitch of the row above the Cast-on Thread. Continue picking up stitches across the row.

(Note: there will be one less stitch to be picked up than there are needles).

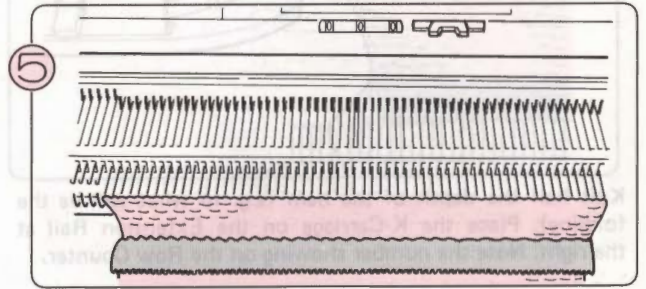

Knit one row with the K-Carriage. Continue knitting in stocking stitch.

## PICOT HEM

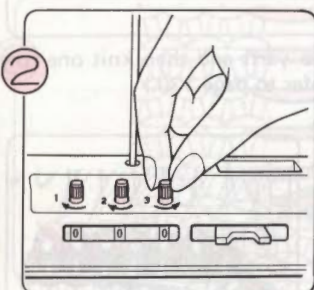
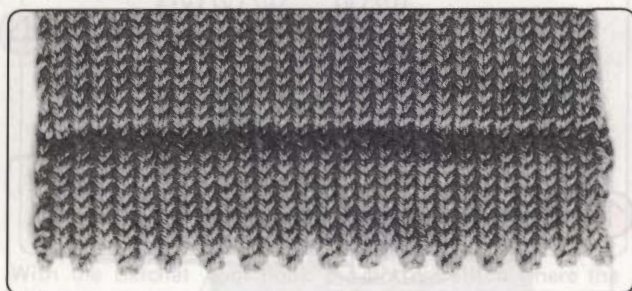

Set the Row Counter to 000 and the Row Counter Tripper to working position.

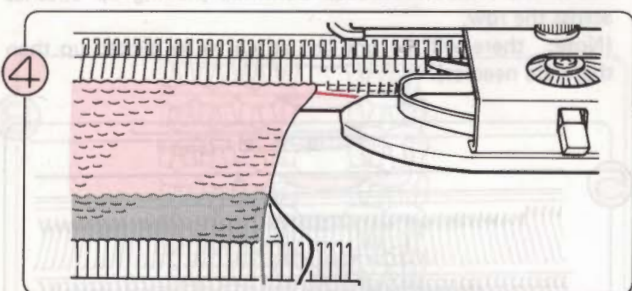
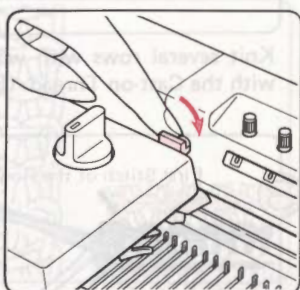

Knit half the depth of the hem (e.g. to what will be the foldline). Place the K-Carriage on the Extension Rail at the right. Note the number showing on the Row Counter.

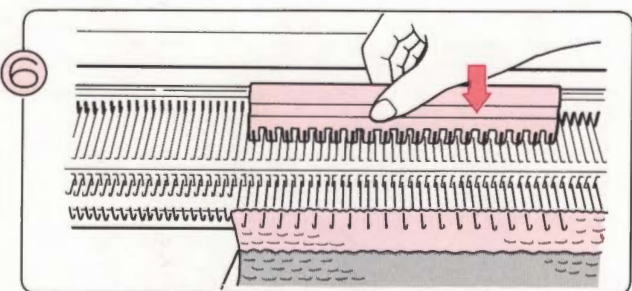

Starting with the second needle in from either end, bring every alternate needle forward to D position using the 1/1 Needle Pusher. The end needles must remain in B position.

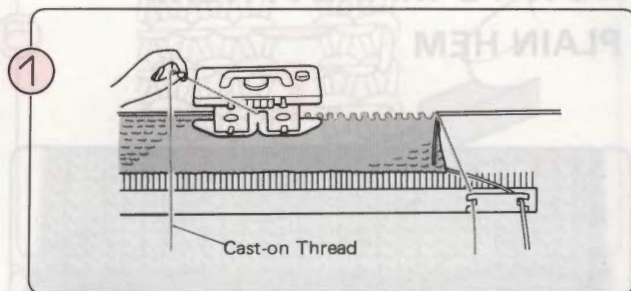

Knit several rows with waste yarn and then knit one row with the Cast-on Thread. (Refer to page 130).

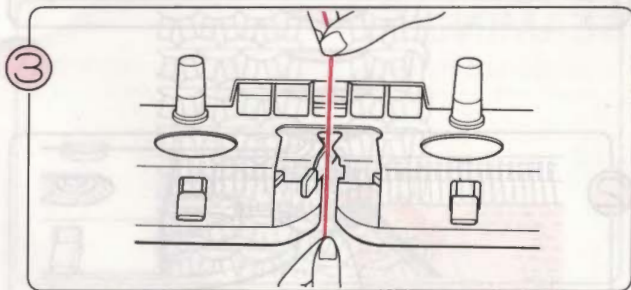

Thread the yarn into Yarn Feeder "A".

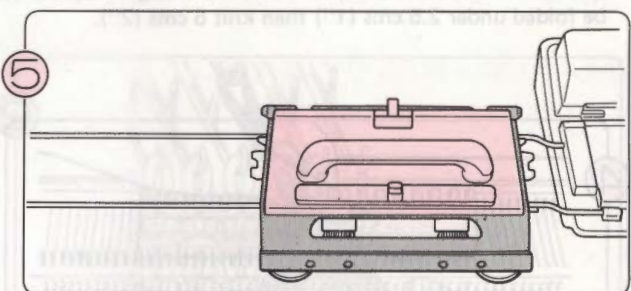

Place the L-Carriage securely on the Extension Rail at the left.

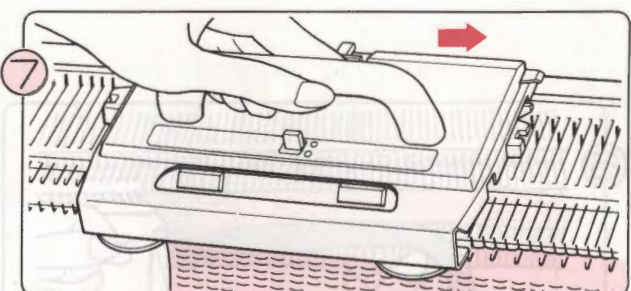

Set the Lace Change Lever to N and move the L-Carriage to the right.

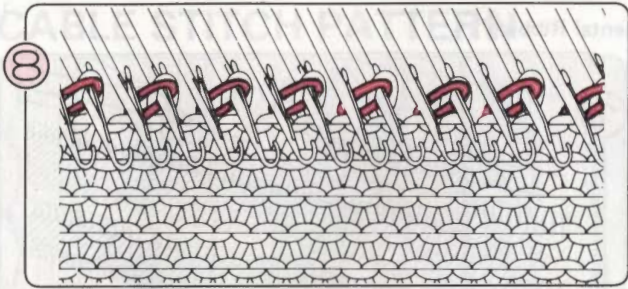

8 Every second stitch has now been transferred to the adjacent needle.

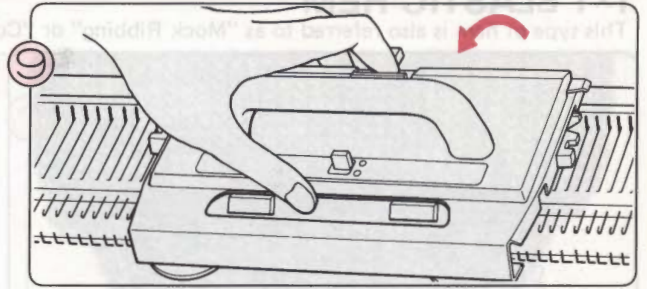

9 Remove the L-Carriage from the machine by depressing the Release Button.

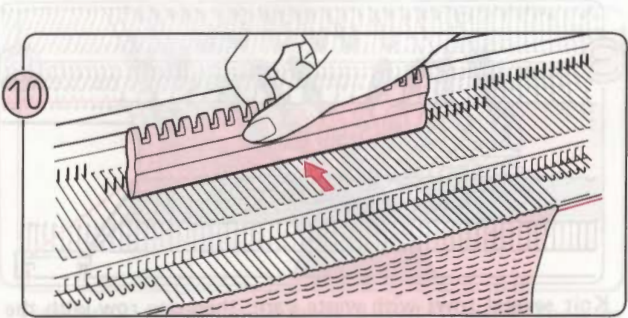

10 Return the needles to B position using the flat side of the 1/1 Needle Pusher.

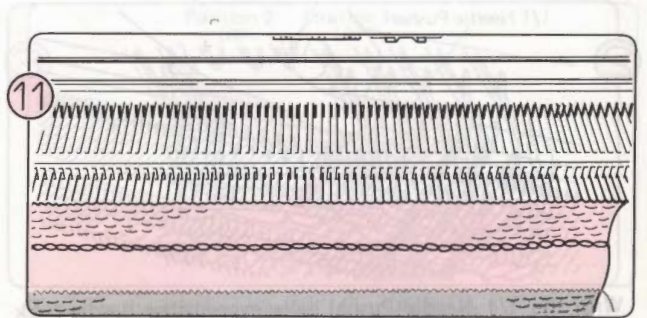

11 Set the Row Counter to 000 and knit the second half of the hem (i.e. the same number of rows as for the first half).

12 Repeat Steps 3 – 6 on pages 136 to finish the hem.

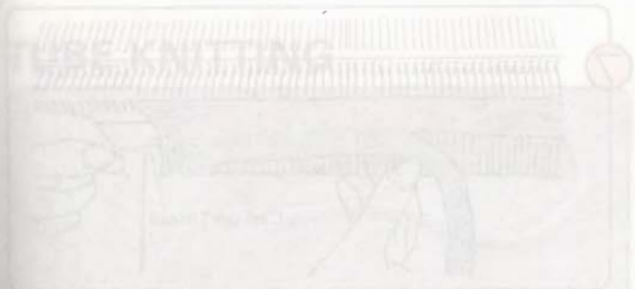



## 1×1 ELASTIC HEM

This type of hem is also referred to as "Mock Ribbing" or "Continental Ribbing".

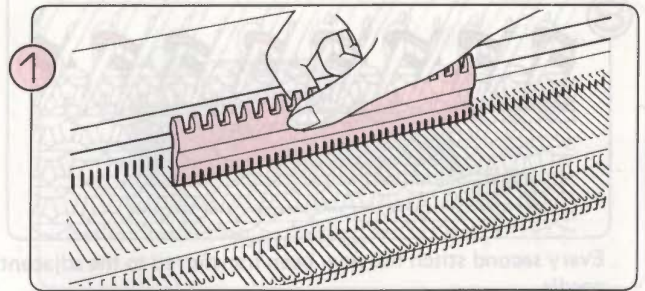
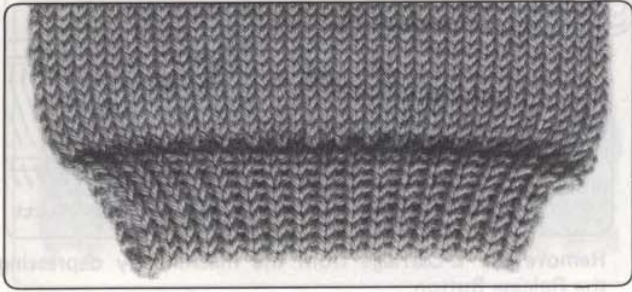

Using the flat side of the 1/1 Needle Pusher, bring forward the required number of needles to B position.

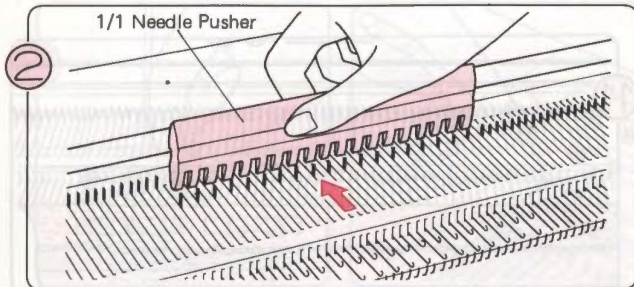

With the 1/1 Needle Pusher take every other needle back to A position.

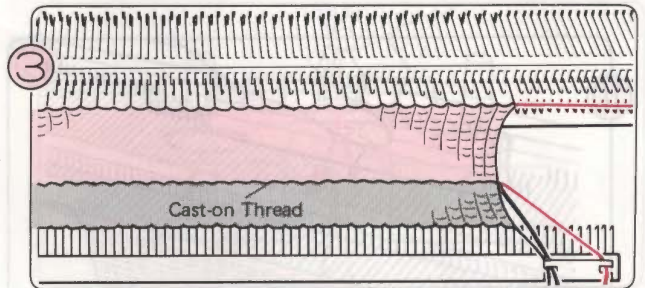

Knit several rows with waste yarn, then one row with the Cast-on Thread. With main yarn working in stocking stitch, knit the number of rows required for double the length of the hem.

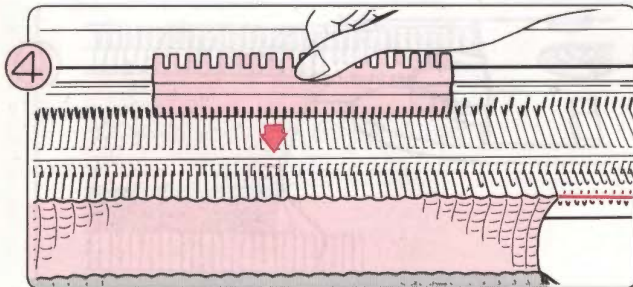

With the flat side of the 1/1 Needle Pusher, bring the needles in A position forward to B position.

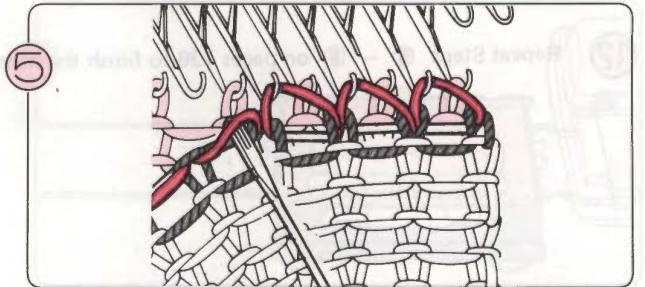

Pick up the stitches in the same way as for the plain hem, and hook them onto the empty needles.

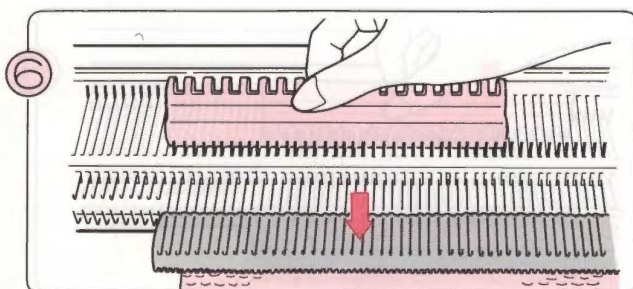

When all the stitches have been picked up, bring the needles forward to E position. Knit one row.

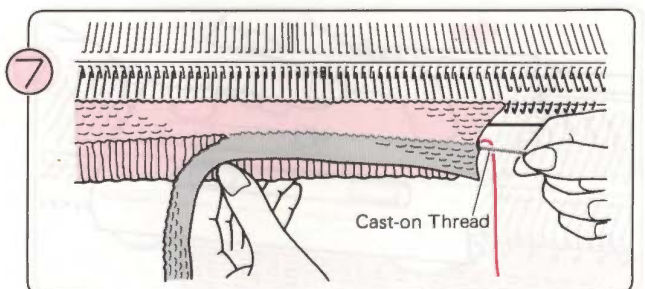

After you have knitted several rows, pull out the Cast-on Thread. The waste yarn drops away.

## CABLE STITCH PATTERN



- Cables are made by crossing two sets of stitches using two Transfer Tools. The following example uses two 3-eyed Transfer Tools.

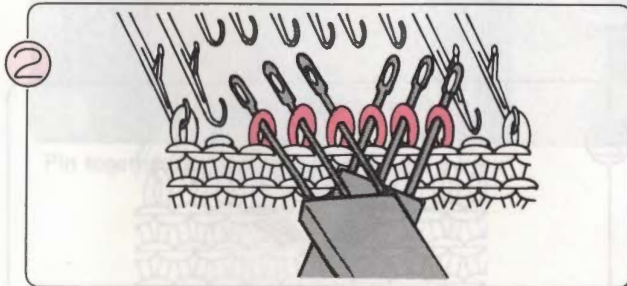

Transfer 3 stitches onto both 3-eyed Transfer Tools as shown.

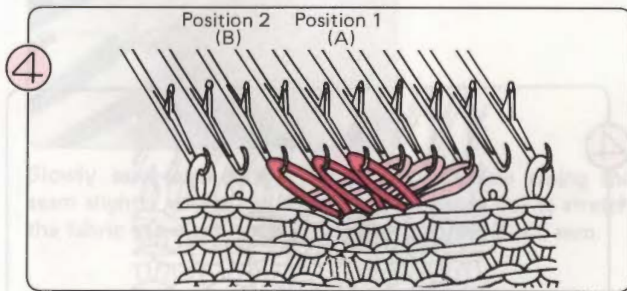

Transfer the stitches marked (B) to Position 2.

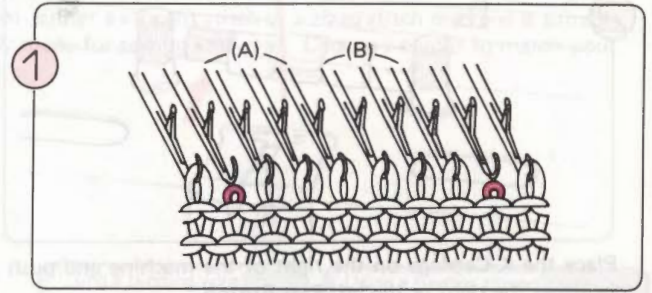

Knit until you reach the point for your first cable cross-over. Drop one stitch on either side of the cable pattern stitches.

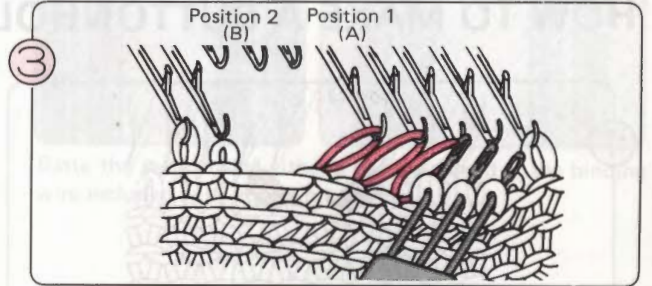

Transfer the stitches marked (A) to Position 1.

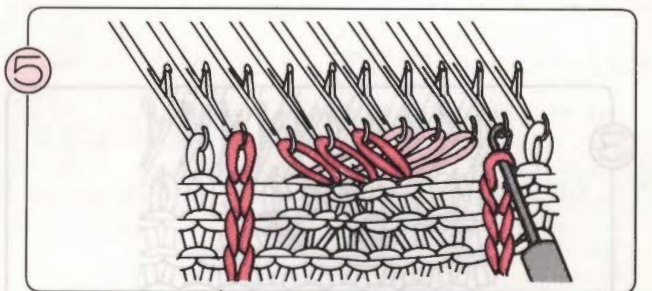

Allow the stitches on either side of the cable which you dropped in Step ①, to ladder down, and using the Latchet Tool reform them into purl stitches.

## TUBE KNITTING

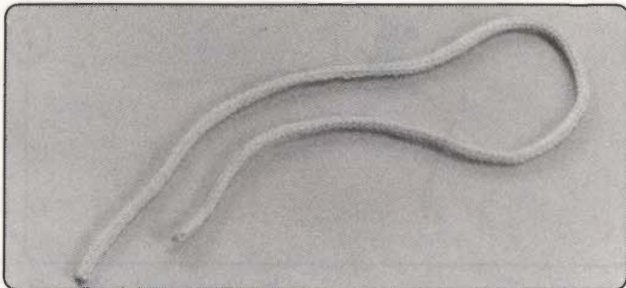

- Using the Skip Stitch facility, you can make seamless tubes. Set the Tension Dial to approx. one number lower (tighter) than you did for the same yarn in stocking stitch.

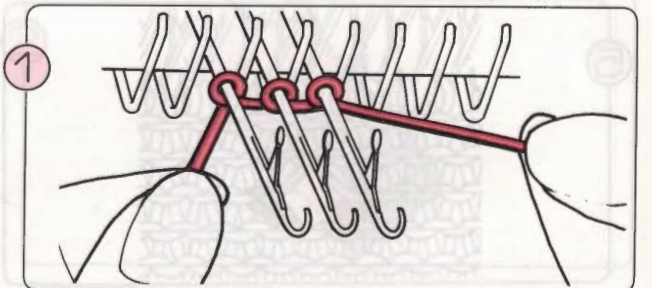

Using the "e" wrap method, cast on 3 or 4 stitches.

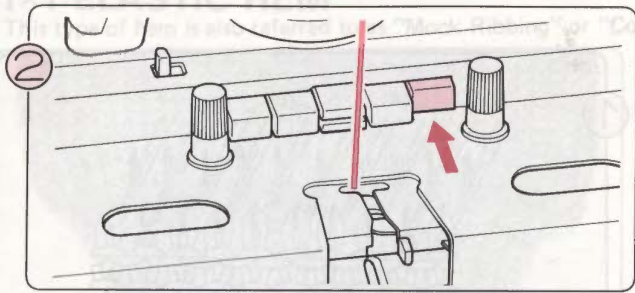

Place the K-Carriage on the right of the machine and push in either the right or the left Part Button.

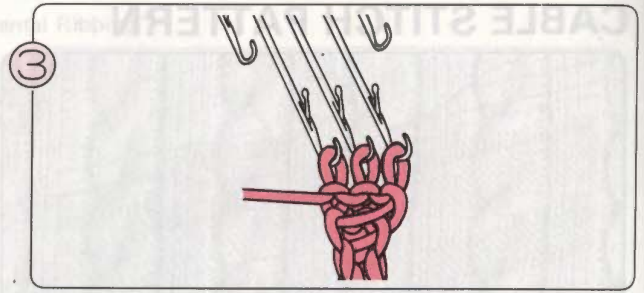

Operate the K-Carriage at the same time pull down the knitting with your other hand.

## HOW TO MAKE A BUTTONHOLE

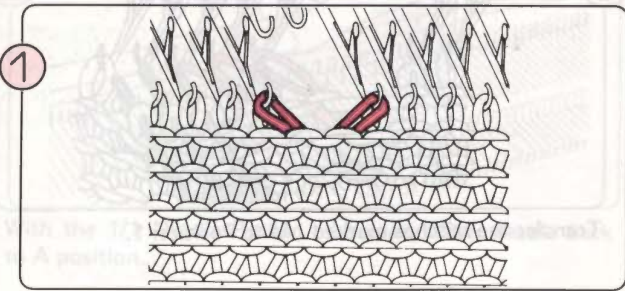

Using the 1/2 Transfer Tool, move the two stitches onto adjacent needles as illustrated.

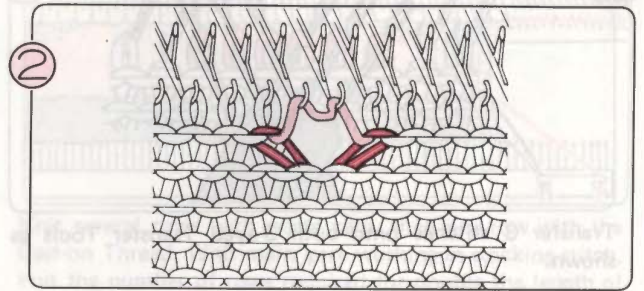

Place empty needles in B position and knit one row. The yarn has hooked over these two needles.

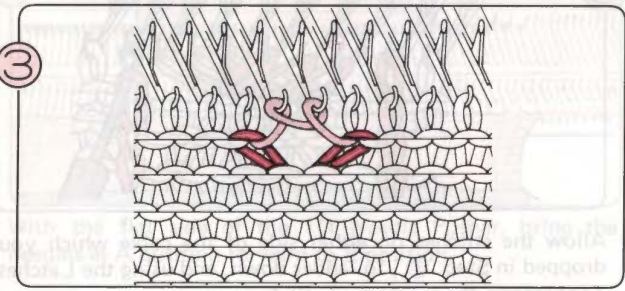

Loop the yarn around the two needles by hand as shown above.

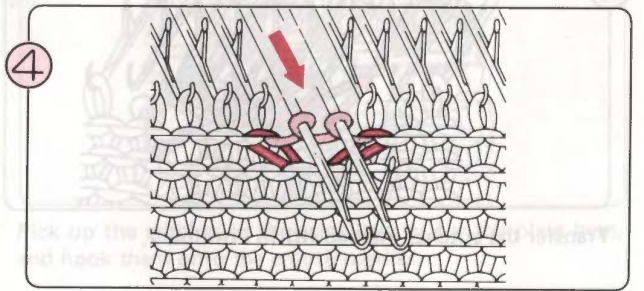

Bring the two needles forward to E position and knit one row.

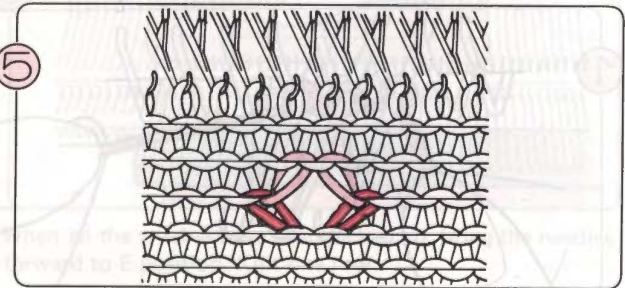

You have now made a buttonhole.

# USING A SEWING MACHINE FOR MAKE-UP

You can use your sewing machine to join your garments together. Either a straight stitch or a zigzag stitch machine is suitable, but it is best to use sewing thread which stretches and is specially made for sewing knitwear. Choose a colour to match your yarn.

WHEN THE NEEDLE IS DOWN, WATCH THE YARN PROPERLY

## BEFORE YOU BEGIN TO SEW

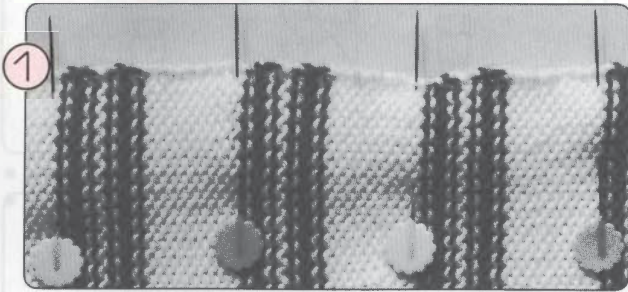

Pin together the parts to be basted.

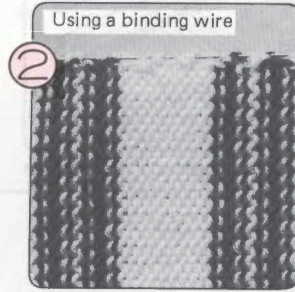

Using a binding wire

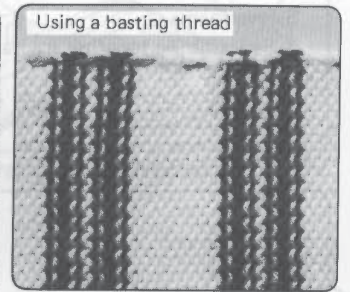

Using a basting thread

Baste the seams using either a basting thread or the binding wire included with your Knit Leader.

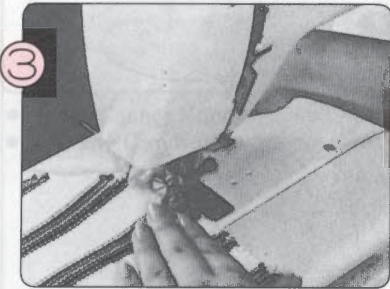

Slowly sew seam with your sewing machine easing the seam slightly whilst you sew, and taking care not to stretch the fabric too much. Allow a seam of approx. 3 – 5 mm.

- Make sure that the machine is not damaged or dirty; if the machine needs oiling or cleaning refer to page 167.
- Make sure you have inserted the yarn correctly into the Yarn Tension Unit. (See page 154)
- Make sure the yarn is flowing freely from the cone or ball.

## ORDER OF MAKE-UP

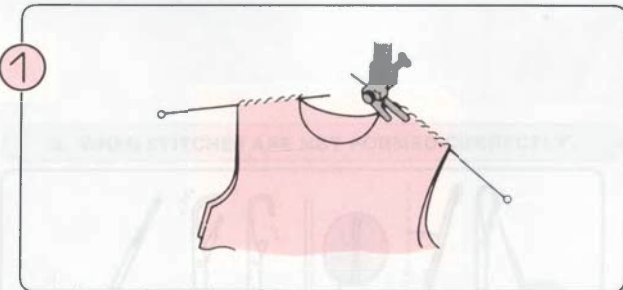

Shoulders (right and left).



Side seams.

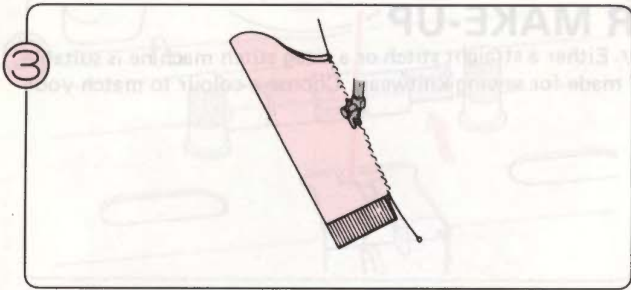

Sleeve seams.

✳ Sew ribbing together by hand.

4

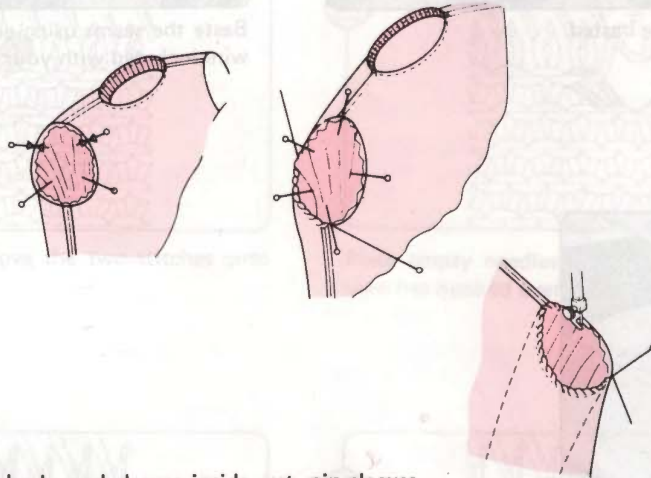

- 1) With garment body and sleeves inside out, pin sleeves around armhole edges.
- 2) Baste the armhole seam, using either basting thread or the binding wire.
- 3) Sew with a sewing machine.

How to set in the sleeves.

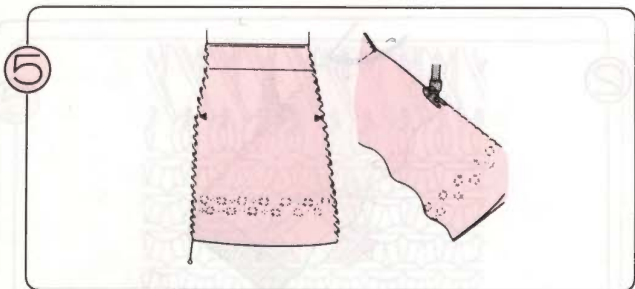

How to sew a skirt.

## PROBLEMS DURING KNITTING

### WHAT TO DO WHEN YOU CANNOT KNIT SMOOTHLY

#### 1. WHEN THE NEEDLES DON'T CATCH THE YARN PROPERLY

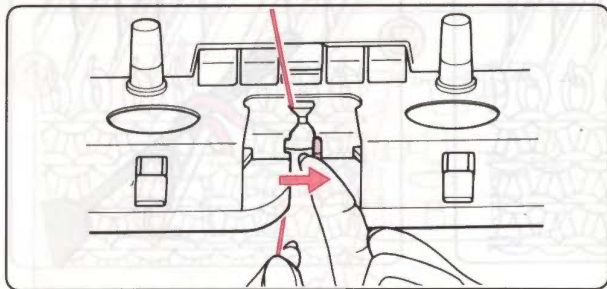

- Is the yarn correctly located in Feeder "A"?
- Is the Yarn Feeder Lever closed?

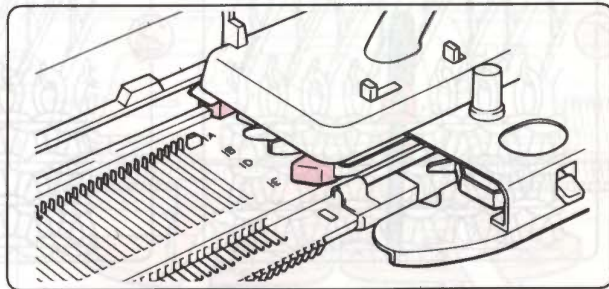

- Is the K-Carriage set correctly on the Needlebed?

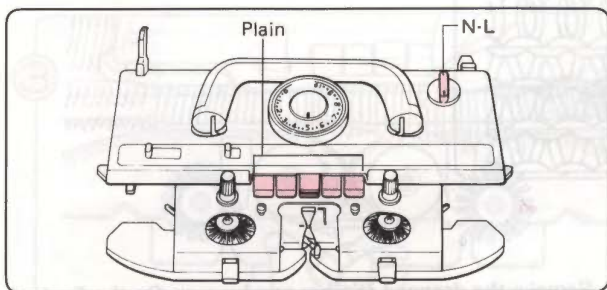

- Is the Change Knob set to N-L?
- Has any Cam Button been pushed in?

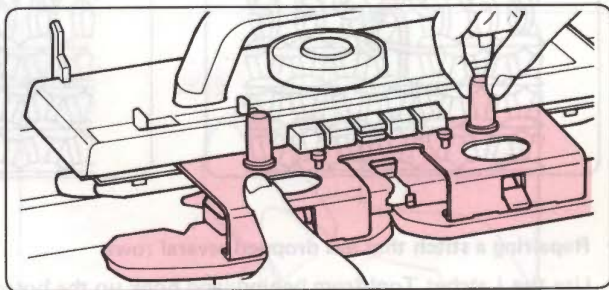

- Is the Sinker Plate Assembly joined correctly to the K-Carriage?

#### 2. WHEN THE K-CARRIAGE IS HARD TO PUSH BACK AND FORTH

- Make sure that the Tension Dial and Tension Discs are adjusted according to the thickness of your yarn. (Tension Dial see page 12. Tension Disc see page 15.)
- Make sure that the machine is not damaged or dirty. If the machine needs oiling or cleaning refer to page 167.
- Make sure you have threaded the yarn correctly into the Yarn Tension Unit. (See page 15.)
- Make sure the yarn is flowing freely from the cone or ball.
- Make sure the Wheel Brushes are rotating freely. If there is yarn wrapped around these, you must remove it.

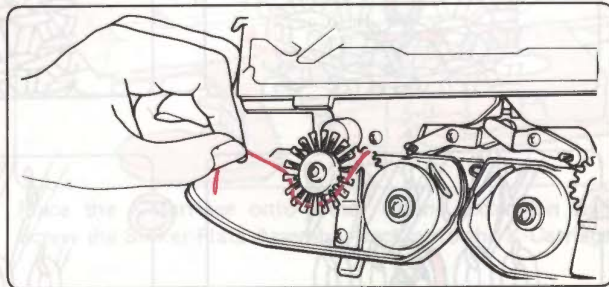

#### 3. WHEN STITCHES ARE NOT FORMED CORRECTLY.

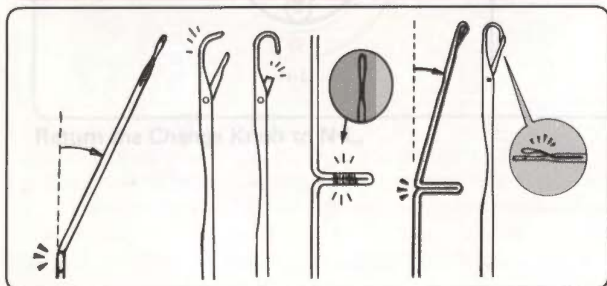

- Is the needle bent? If so, change it for a new one. (See p. 157.)
- Place the Rubber Wheels into working position. (See p. 18.)

#### 4. HOW TO PICK UP A DROPPED STITCH

- **Repairing a dropped stitch.**

Insert the Transfer Tool into the stitch on the row below the dropped stitch. Re-make the dropped stitch as illustrated.

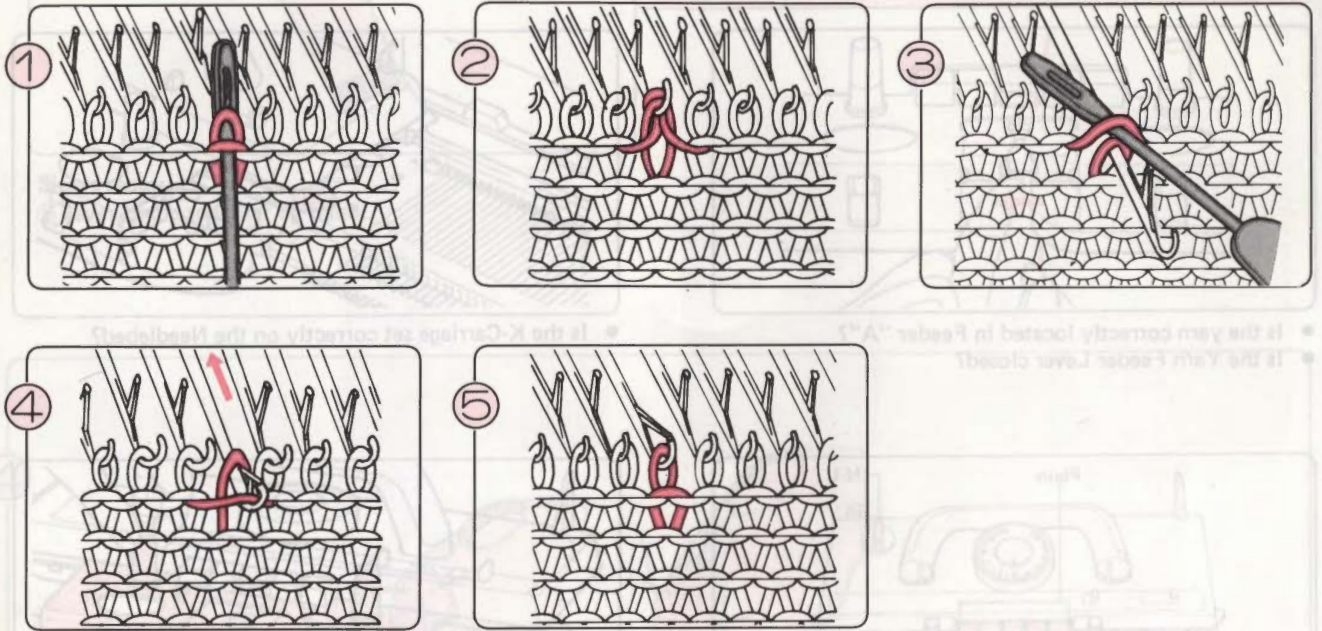

- **Repairing a stitch that has dropped several rows.**

Use the Latchet Tool from behind, and hook up the bottom stitch. Remake the dropped stitches row by row. On the final row, transfer the stitch from the Latchet Tool to a Transfer Tool, and replace it onto the needle.

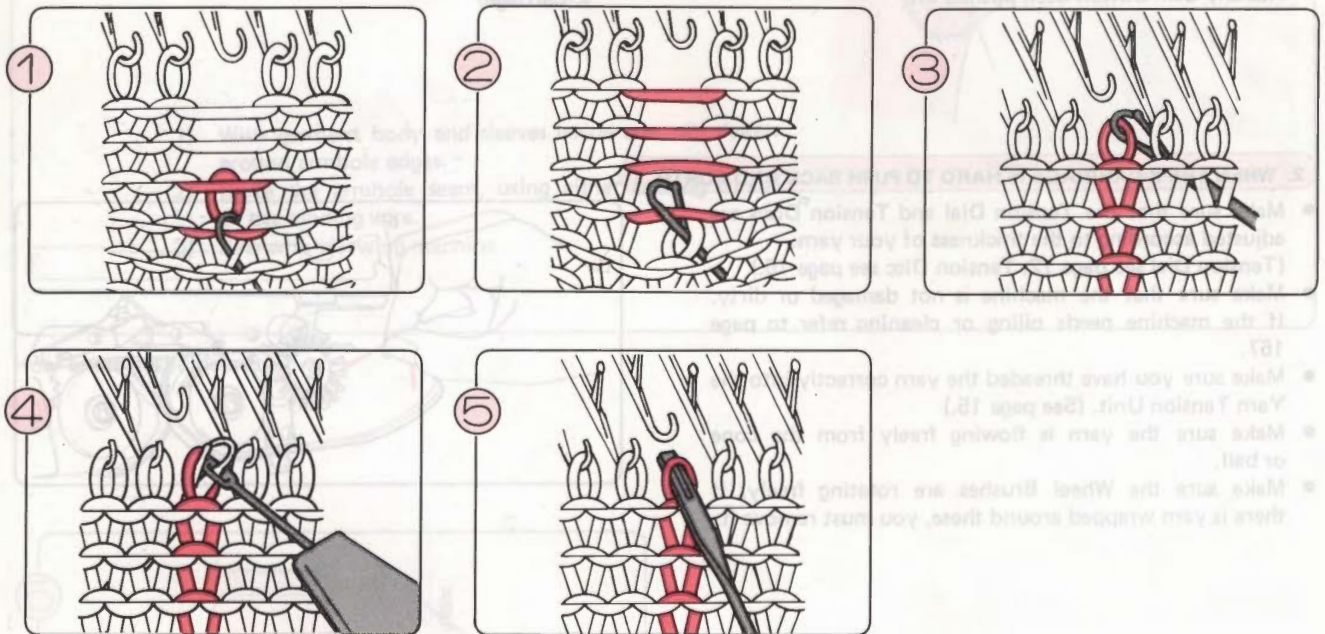

# WHAT TO DO IF YOU MAKE MISTAKES AS YOU KNIT STOCKING STITCH AND PLATING

## 1. IF THE CARRIAGE SHOULD JAM

- Do not attempt to move the K-Carriage by force. Proceed as follows:

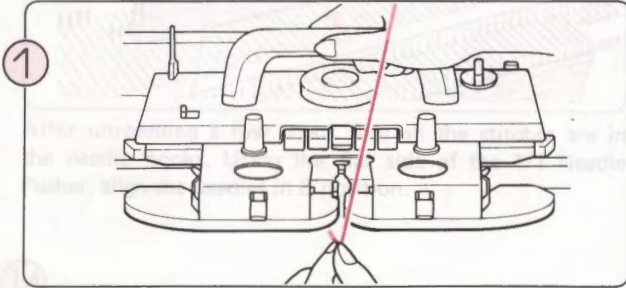

Take the yarn out of the Yarn Feeder.

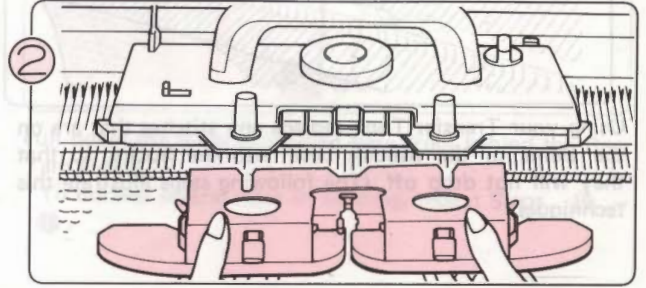

Loosen the knobs and remove the Sinker Plate Assembly.

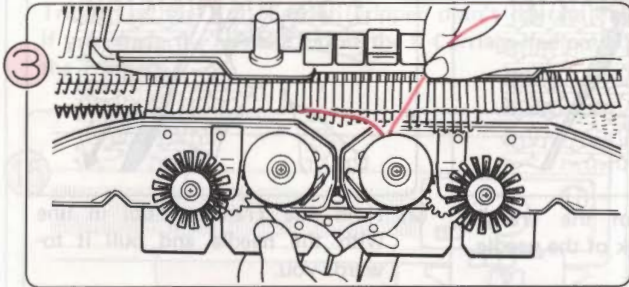

Untangle any yarn that has become wrapped around the Wheels.

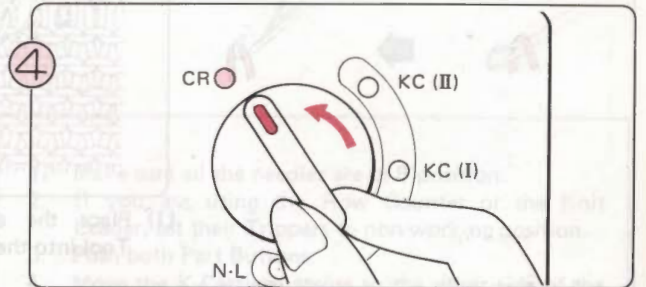

Set the Change Knob to CR to release the K-Carriage from the machine.

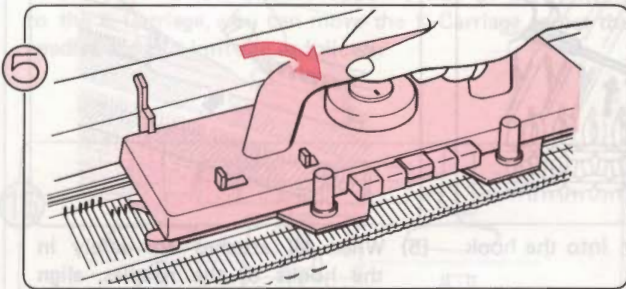

Lift up the K-Carriage towards you and remove it from the needlebed.

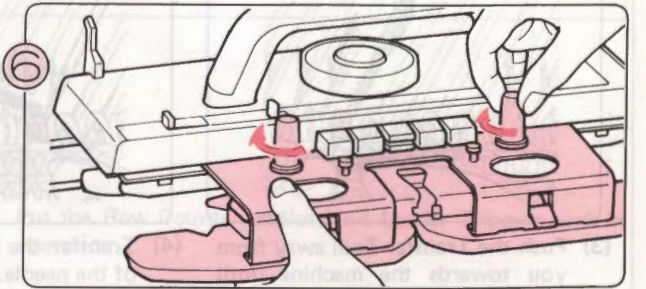

Place the K-Carriage onto either of the Extension Rails. Screw the Sinker Plate Assembly back onto the K-Carriage.

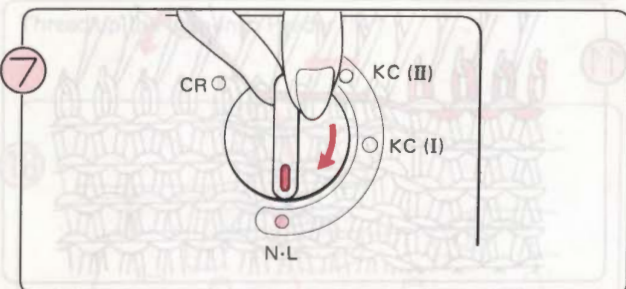

Return the Change Knob to N-L.

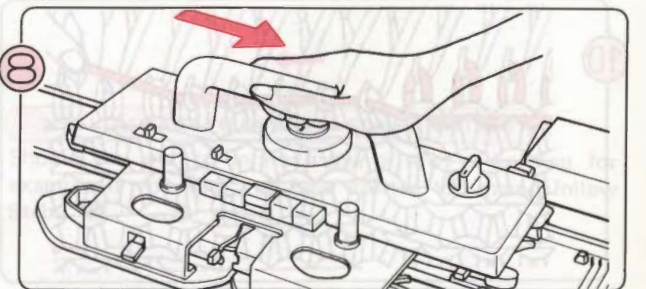

Slide the K-Carriage across onto the needlebed and check it is placed correctly.



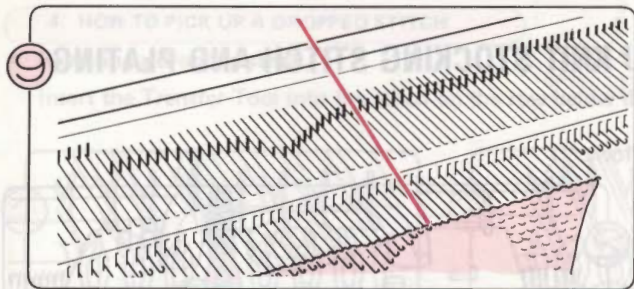

Using your Transfer Tool, replace any stitches that are on the stems of the needles back into the hooks, so that they will not drop off. (The following steps illustrate this technique).

Stitch behind latch on stem of needle

Stitch in needle hook

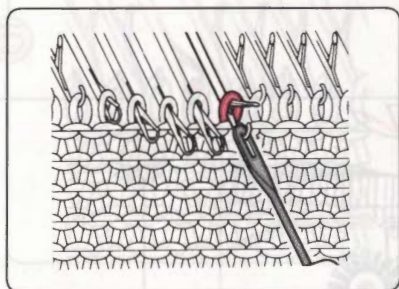

(1) Place the eye of the Transfer Tool into the hook of the needle.

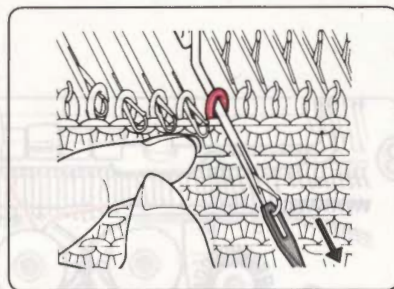

(2) Hold the Transfer Tool in line with the needle and pull it towards you.

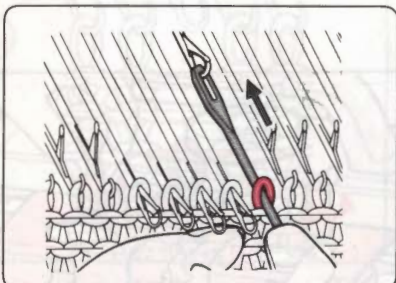

(3) Push the Transfer Tool away from you towards the machine until the stitch is on the Transfer Tool.

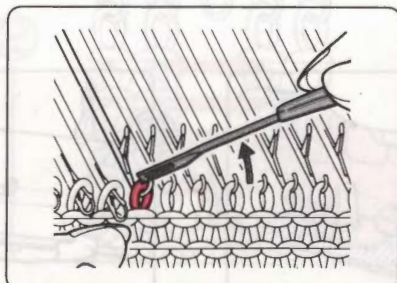

(4) Transfer the stitch into the hook of the needle.

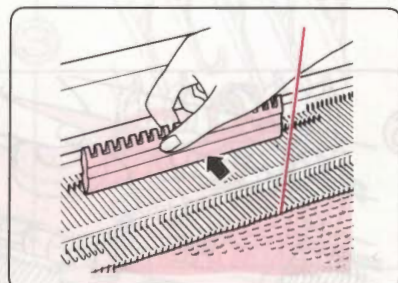

(5) When all stitches are safely in the hooks of the needles, align all needles in B position using the flat edge of the 1/1 Needle Pusher.

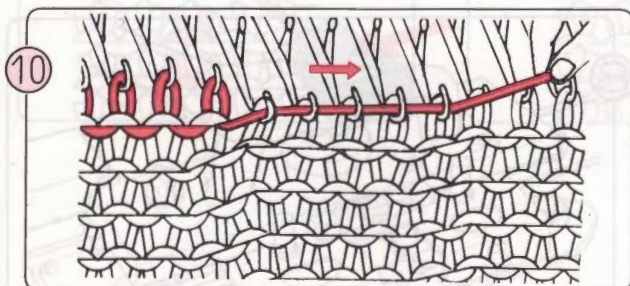

Pull the yarn sideways slightly so that it becomes tight in the needle hooks.

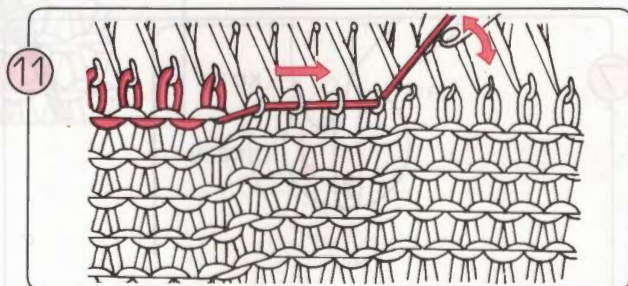

Now pull the yarn in an upwards direction to unravel the knitting. The stitches are undone and those from the row below will slip into the needle hooks. Work a few stitches at a time and repeat Steps 10 & 11 across the row.

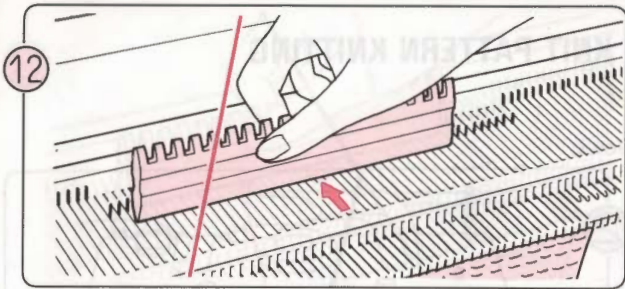

After unravelling a row check that all the stitches are in the needle hooks. Using the flat side of the 1/1 Needle Pusher, align the needles in B position.

14

Don't forget to wind back the Row Counter and Knit Leader (if used) by the number of rows you have unravelled.

\*You don't need to count the last row if the Row Counter Tripper or the Knit Leader Tripper didn't operate e.g. if you made the mistake before the K-Carriage had passed the Trippers.

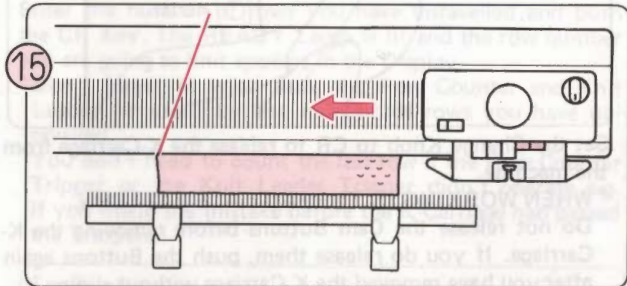

If the yarn is now on the opposite side of the knitting to the K-Carriage, you can move the K-Carriage across the needles without knitting as follows:

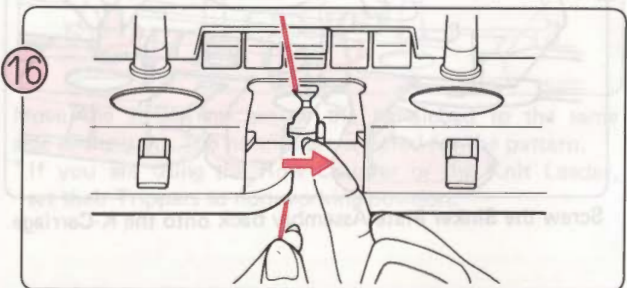

Thread up the yarn into Feeder "A".

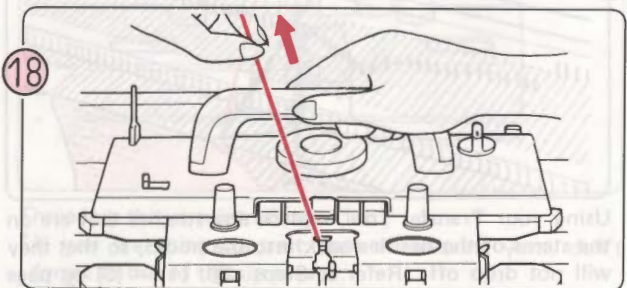

Continue knitting with the K-Carriage, pulling the yarn slightly on the first row to remove any slackness.

13

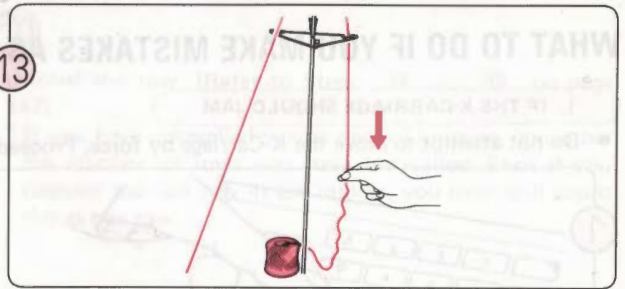

Pull down the loose unravelled yarn from behind the Rear Yarn Guide.

\* To unravel several rows of knitting, repeat Steps 10 - 12.

1. Make sure all the needles are in B position.
2. If you are using the Row Counter or the Knit Leader, set their Trippers to non-working position.
3. Push both Part Buttons.
4. Move the K-Carriage across to the other side of the needlebed.
5. Cancel both Part Buttons by sliding the Cam Button Release Lever.

17

Put the Row Counter and/or Knit Leader Trippers back in operation.

## 2. IF YOU WANT TO UNRAVEL SOME KNITTING

Should you wish to unravel a row or rows of knitting, for example if you find you have knitted too many, follow Steps 10 - 18 above.

# WHAT TO DO IF YOU MAKE MISTAKES AS YOU KNIT PATTERN KNITTING

## 1. IF THE K-CARRIAGE SHOULD JAM

- Do not attempt to move the K-Carriage by force. Proceed as follows:

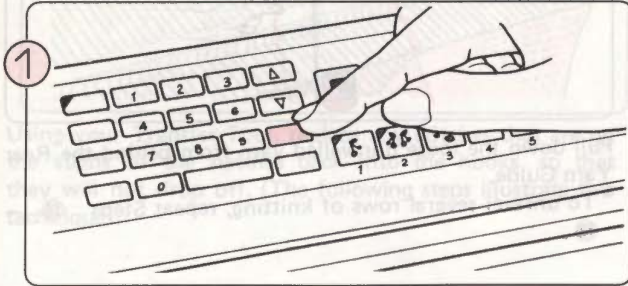

Push the CR Key. The Ready Lamp flashes on and off.

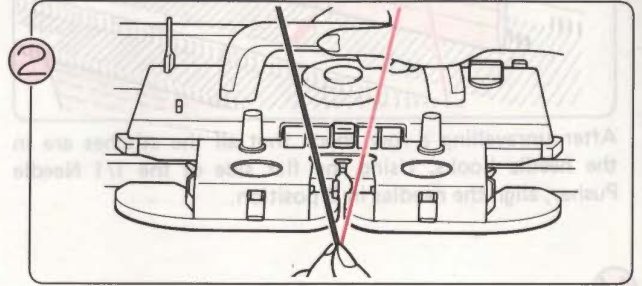

Take the yarn out of the Yarn Feeder.

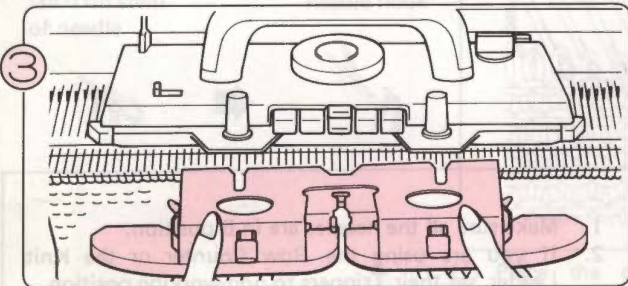

Loosen the knobs and remove the Sinker Plate Assembly.

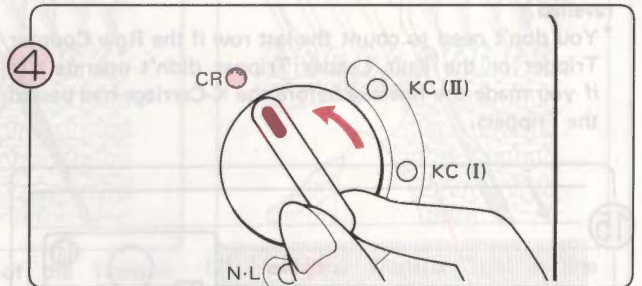

Set the Change Knob to CR to release the K-Carriage from the machine.

### \*WHEN WORKING IN THREAD LACE PATTERN

Do not release the Cam Buttons before removing the K-Carriage. If you do release them, push the Buttons again after you have removed the K Carriage without sliding it.

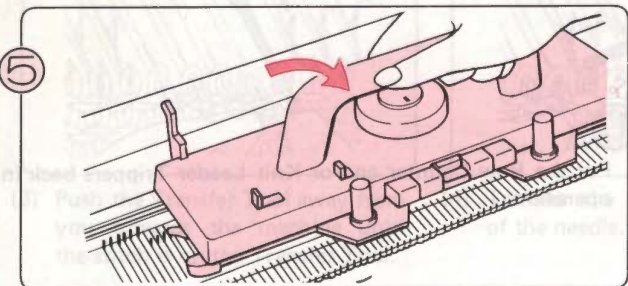

Place the K-Carriage onto either of the Extension Rails. Set the Change Knob to N-L.

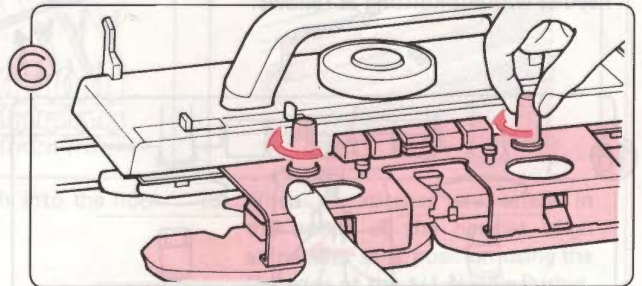

Screw the Sinker Plate Assembly back onto the K-Carriage.

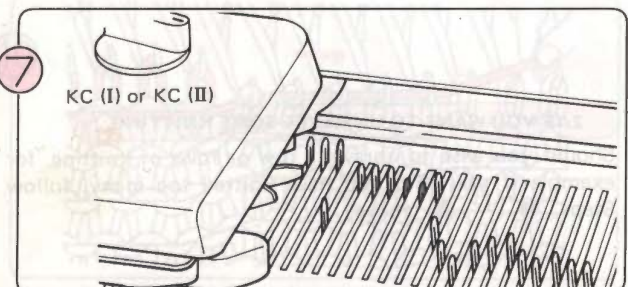

If some stitches have slipped back down the Needlebed, set the Change Knob to KC (I) or KC (II) and slide the K Carriage back and forth across the Needlebed without knitting to bring the needles up.

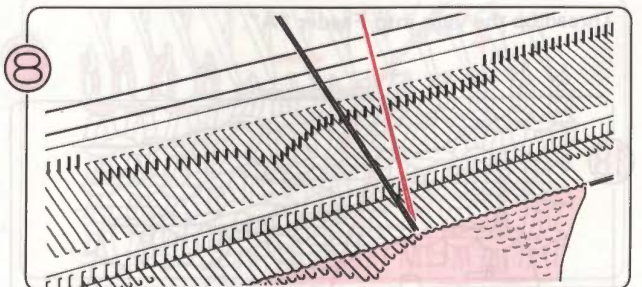

Using your Transfer Tool, replace any stitches that are on the stems of the needles back into the hooks, so that they will not drop off. (Refer to Steps (1) – (5) on page 147.)

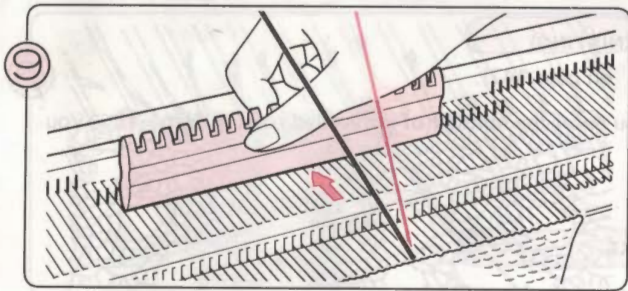

When all stitches are safely in the hooks of the needles, align all needles in B position using the flat edge of the 1/1 Needle Pusher.

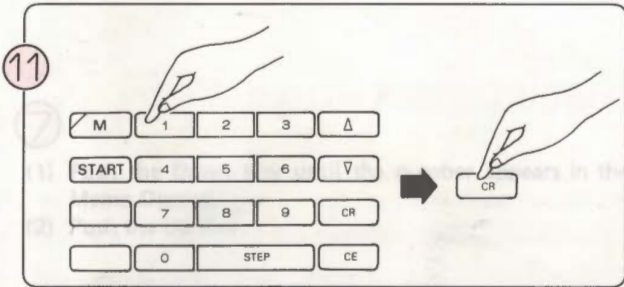

Enter the number of rows you have unravelled and push the CR Key. The READY Lamp is lit and the row number you are going to knit appears in the Display.

\* Don't forget to wind back the Row Counter and Knit Leader (if used) by the number of rows you have unravelled.

\* You don't need to count the last row if the Row Counter Tripper or the Knit Leader Tripper didn't operate e.g. if you made the mistake before the K-Carriage had passed the Trippers.

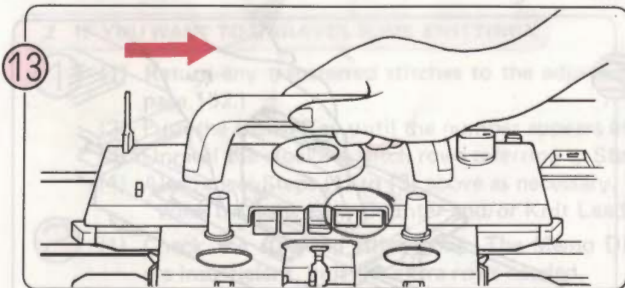

Move the K-Carriage across the needlebed to the same side as the yarn. The needles are selected for the pattern.

\* If you are using the Row Counter or the Knit Leader, set their Trippers to non-working position.

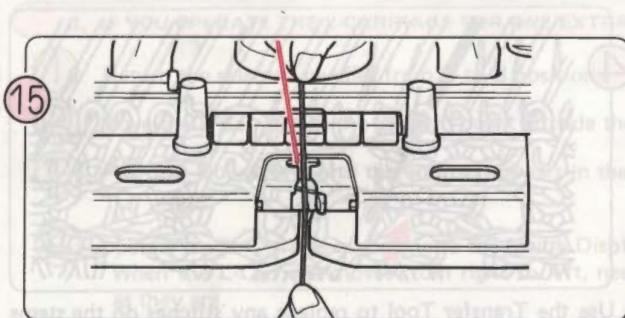

Thread up the yarn into Feeder "A".

\* If you are using contrast yarn or weaving yarn, don't forget to thread this up as well.

10

Unravel the row. (Refer to Steps 10 - 13 on page 147).

\* If you have unravelled several rows of knitting, remember the number of rows you have unravelled. Even if you stopped the last row in the middle, you must still count this as one row.

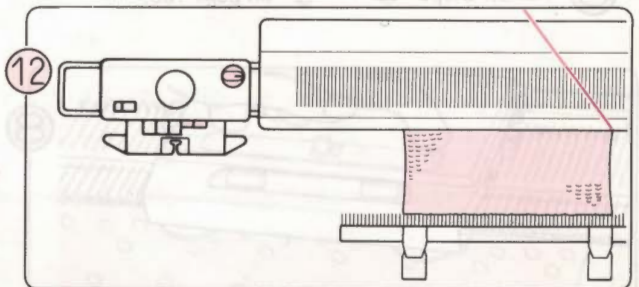

Place the K-Carriage at the opposite end of the needlebed to the yarn. (If the yarn is on the same side as the K-Carriage, refer to page 148 for how to pass the carriage across the needles without knitting.) Push both Part Buttons and set the Change Knob to KC (I) or KC (II).

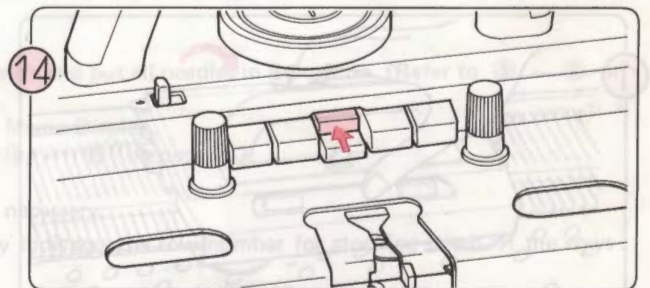

Push the Cam Buttons according to the pattern.

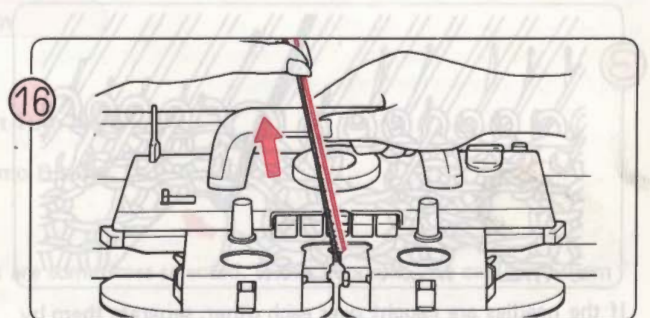

Continue knitting with the K-Carriage, pulling the yarn slightly on the first row to remove any slackness.

\* Put the Row Counter and/or Knit Leader Trippers back in operation.

**2. IF YOU WANT UNRAVEL SOME KNITTING  
(WHEN THE CARRIAGE HAS GONE PAST THE END OF THE KNITTING)**

- ① Begin by unravelling the rows. (Refer to Steps ⑩ – ⑬ on page 147).
- ② Now follow Steps ⑪ – ⑮ on page 150. (Before you enter the number of unravelled rows in Step ⑪, you should clear the number in the Display with the CE Key.)

**3. IF THE SELECTED NEEDLES ARE PUSHED BACK BY MISTAKE**

- ① Bring all the needles back to B position and take the yarn out of the Yarn Feeder.
- ② Push the CE Key. Enter 0 and push the CR Key.
- ③ Follow Steps ⑫ – ⑰ on page 150.

**WHAT TO DO IF YOU MAKE MISTAKES AS YOU KNIT LACE OR FINE LACE PATTERN KNITTING**

**1. IF THE L-CARRIAGE SHOULD JAM**

- Do not attempt to move the L-Carriage by force. Proceed as follows:

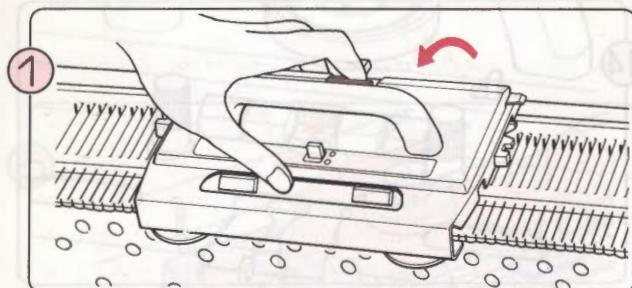

Remove the L-Carriage by pushing the Release Button. If the L-Carriage is caught on the needles, take care when removing it.

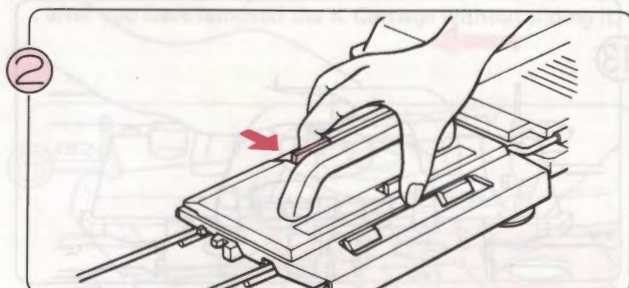

Place the L-Carriage securely on the left Extension Rail using the Release Button.

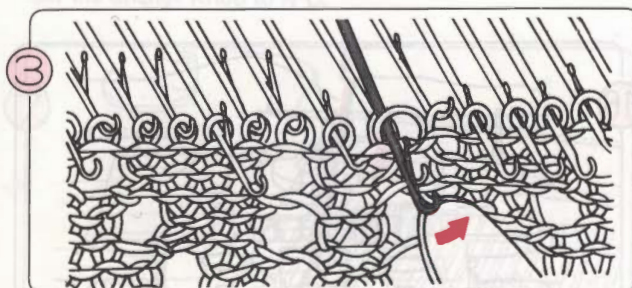

If the needles are caught over each other, separate them by lifting the tips as shown above.

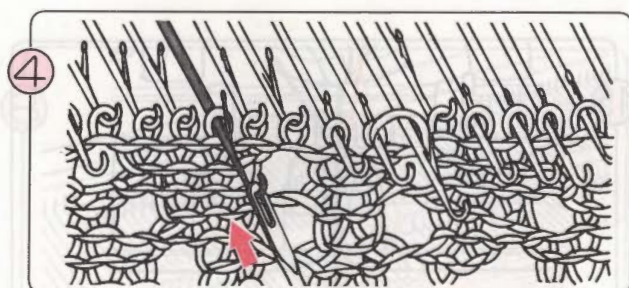

Use the Transfer Tool to replace any stitches on the stems of the needles back into the hooks.

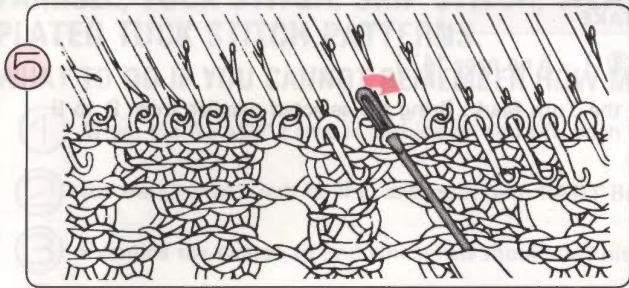

Return any stitches that have been transferred back onto the adjacent needles using the Transfer Tool.

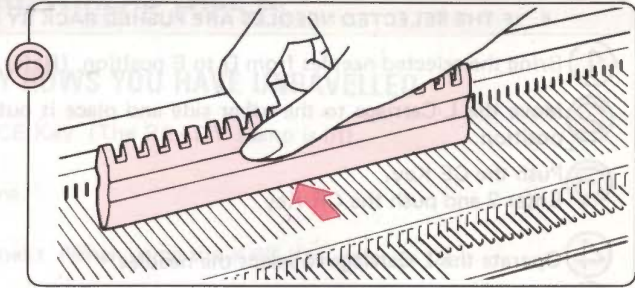

Bring all needles back into B position.

7

- (1) Push the Down Key until the number appears in the Memo Display.
- (2) Push the Up Key.

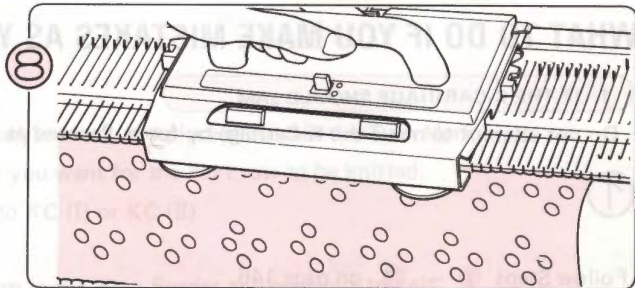

Continue knitting, operating the L-Carriage and the K-Carriage according to the Memo Display.

## 2. IF YOU WANT TO UNRAVEL SOME KNITTING

- 1
  - (1) Return any transferred stitches to the adjacent needles and put all needles in B position. (Refer to 5 – 6 on page 152.)
  - (2) Push the Down Key until the number appears in the Memo Display.
  - (3) Unravel the stocking stitch rows referring to Steps 10 – 13 on page 147.
  - (4) Also repeat Steps (1) to (3) above as necessary.
    - \*Wind back the Row Counter and/or Knit Leader if necessary.
- 2
  - (1) Check the stocking stitch rows. The Memo Display indicates the row number for stocking stitch. If the rows are insufficient, knit the extra rows needed.
  - (2) Push the UP Key.
    - \*Don't forget to set the Row Counter and Knit Leader Trippers back into action.
  - (3) Continue knitting, operating the L-Carriage and the K-Carriage according to the Memo Display.

## 3. IF YOU OPERATE THE L-CARRIAGE FOR ONE EXTRA ROW

- 1 Return the selected needles from D to B position.
- 2 Move the L-Carriage to the left and put it outside the left Turn Mark.
- 3 Push the Down Key until the number appears in the Memo Display.
- 4 Operate the K-Carriage according to the Memo Display.
  - \*When the L-Carriage moves from right to left, needles are sometimes selected. If this happens, you can leave them as they are.
- 5 Push the Up Key.
- 6 Operate the L-Carriage and the K-Carriage according to the Memo Display.

#### 4. IF THE SELECTED NEEDLES ARE PUSHED BACK BY MISTAKE

- 1 Bring the selected needles from D to B position. (Refer to ⑨ 1 – 5 on page 147.)
- 2 Move the L-Carriage to the other side and place it outside the Turn Mark. Bring the selected needles from D to B position.
- 3 Push the CE Key.  
Enter 2 and push the CR Key.
- 4 Operate the L-Carriage to select the needles.
- 5 Continue knitting operating the L-Carriage and K-Carriage according to the Memo Display.

## WHAT TO DO IF YOU MAKE MISTAKES AS YOU KNIT INTARSIA KNITTING

### 1. IF THE K-CARRIAGE SHOULD JAM

- Do not attempt to move the K-Carriage by force. Proceed as follows:

①

Follow Steps ② – ⑫ on page 146.

\* Wind back the Row Counter and Knit Leader (if used) by the number of rows you have unraveled.

\* You don't need to count the last row if the Row Counter Tripper or the Knit Leader Tripper didn't operate e.g. if you made a mistake before the K-Carriage had passed the Trippers.

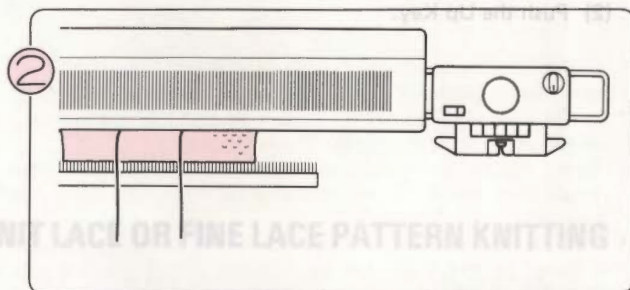

If the K-Carriage is at the same side of the knitting as the yarn, remove the K-Carriage from the needlebed and place it at the opposite side.

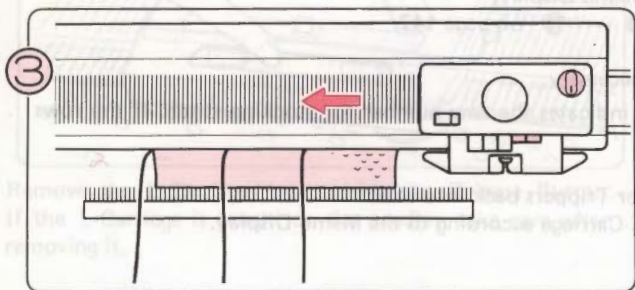

Push in both Part Buttons and move the K-Carriage across to the other side of the needlebed.

\* If you are using the Row Counter or the Knit Leader, set their Trippers to non-working position.

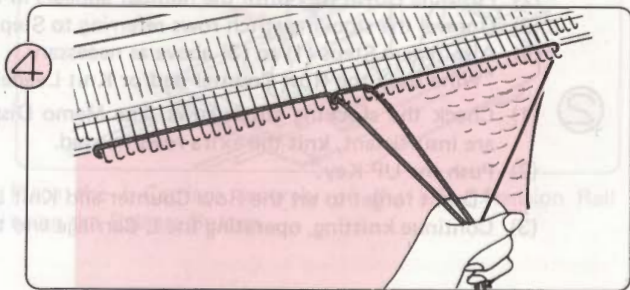

Lay the yarns according to the pattern and continue intarsia knitting.

\* Don't forget to set the Row Counter and Knit Leader Trippers back in operation.

### 2. IF YOU WANT TO UNRAVEL SOME KNITTING

- 1 Follow Steps ⑨ (1) – ⑫ on page 147 then follow Steps ② – ④ on this page.

# FAIRISLE, TUCK STITCH, SKIP STITCH, WEAVING, THREAD LACE & PLATED TUCK STITCH PATTERNS.

## WHAT TO DO IF YOU CANNOT REMEMBER HOW MANY ROWS YOU HAVE UNRAVELLED.

- ① When the READY Lamp is flashing on and off, push the CE Key. (The READY Lamp is lit).
- ② Set the Change Knob to N-L. and push both PART Buttons.
- ③ Examine the swatch to find which row should be knitted next. (When using the KRC Key, refer to C.)
- ④ Now follow the instructions according to the setting of the Variation Keys.

### (A) When the DOUBLE LENGTH Key and KRC Key are not in use.

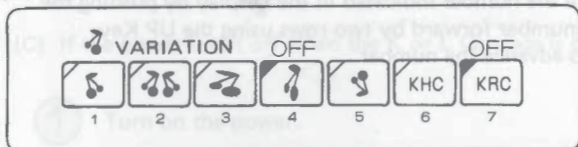

- (1) Move the K-Carriage to the opposite side of the needlebed to the yarn end, and place it outside the Turn Mark.
- (2) Push the UP or DOWN Key until the Display shows the number you want for the next row to be knitted.
- (3) When the Display shows the correct row, set the Change Knob to KC (I) or KC (II)
- (4) Move the K-Carriage across the needlebed to select the needles.
- (5) Push the Cam Button(s) according to the pattern, check the yarn in the Yarn Feeder and continue to knit.

### (B) When using the DOUBLE LENGTH Key.

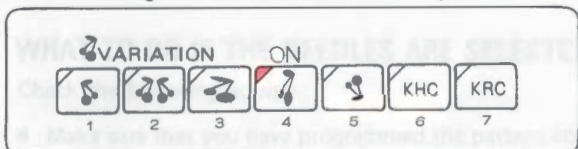

- When you knit double length patterns, each row is knitted twice. Check whether your next row is the first or the second row of the double length pattern.
- The steps are the same as for "(A) (When the DOUBLE LENGTH and KRC Keys are not in use)". However, please bear the following points in mind when you reach Step (2).  
When you push the UP or DOWN Key, the same number will appear in the Display twice. If the row you want is the first row of the double length pattern, use the number the first time it appears. If the row you want is the 2nd row, then use the number the 2nd time it appears.

### (C) When using the KRC Key or KRC Key and the DOUBLE LENGTH Key.

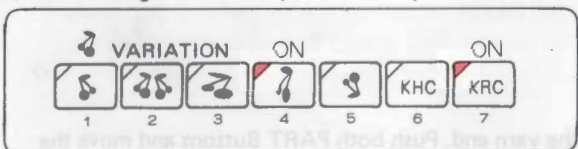

- (1) Unravel your knitting until the main yarn end is at the right of the swatch.
- (2) Place the KR-Carriage at the righthand side of the Ribber bed. (If the KR-Carriage is on the left side of the machine, release it from the needlebed and place it at the right).
- (3) Place the K-Carriage outside the left Turn Mark. Check the contrast colour stitches to find out which row number should be knitted next.
- (4) Push the UP or the DOWN Key until the Display shows the number you want for the next row to be knitted.  
NOTE: When you are using the DOUBLE LENGTH Key, the same number will appear in the Display four times. Use the number the first time it appears, regardless of whether the DOUBLE LENGTH Key is on or off.
- (5) Set the Change Knob to KC(II) and move the K-Carriage across the needlebed to select the needles.
- (6) Connect the K and KR Carriages, check the yarn in the Yarn Feeder and continue to knit.



## WHAT TO DO WHEN YOU HAVE ENTERED THE WRONG NUMBER FOR THE ROWS YOU HAVE UNRAVELLED.

(A) The number you have entered is smaller than the correct figure. (e.g. You have unravelled 4 rows, but entered the number as 3 and then pushed the CR Key.)

- 1 Work out the number of rows you are short, and turn back the number indicated in the Display by pushing the DOWN Key. In the example, you are one row short, so take the number back by one row using the DOWN Key. If you are using the UPSIDE DOWN Key, use the UP Key to turn back the number.
- 2 Now follow the instructions on page 150 Steps 12 - 16 .

(B) The number you have entered is larger than the correct figure. (e.g. You have unravelled 2 rows, but entered the number as 4 and then pushed the CR Key.)

- 1 Work out the number of rows you have too many, and advance the number indicated in the Display by pushing the UP Key. In the example, you have 2 rows extra, so advance the number forward by two rows using the UP Key. If you are using the UPSIDE DOWN Key, use the DOWN Key to advance the number.
- 2 Now follow the instructions on page 150 Steps 12 - 16 .

## SHOULD YOU TURN ON THE M LAMP BY MISTAKE ...

Push the C Key. (The M Lamp goes off).

## WHAT TO DO IF THE ELECTRIC POWER IS CUT OFF WHILST YOU ARE KNITTING.

(A) If the power is cut off whilst stitches are actually being knitted with the K-Carriage.

- 1 Move the K-Carriage to outside the Turn Mark on the side towards which it has moved.
- 2 Turn on the power.
- 3 Push the CR Key. (The READY Lamp flashes on and off.)
- 4 Unravel the knitting down to a row of correct pattern knitting.
- 5 Place the K-Carriage at the opposite side of the needlebed to the yarn end. Push both PART Buttons and move the K-Carriage across the needlebed from outside the Turn Mark, to select the needles.
- 6 Push the CE Key. (The READY Lamp is lit.)
- 7 Push the Cam Buttons according to your pattern. Check the yarn in the Yarn Feeder and continue knitting.

(B) If the power is cut off whilst you are actually transferring knitting with the L-Carriage.

- 1 Move the L-Carriage to the side towards which it was moving, and place it on the extension rail at the opposite side.
- 2 Turn on the power.
- 3 Push the CR Key. (The READY Lamp flashes on and off).
- 4 Return all selected needles to B position.
- 5 Move the L-Carriage across the needlebed from outside the Turn Mark to select the needles.
- 6 Push the CE Key. (The READY Lamp is lit).
- 7 Continue knitting according to the Memo Display.

(C) If the power is cut off when the K or L Carriage is clear of the knitting.

- 1 Turn on the power.
- 2 Move the K or L Carriage across the Turn Mark and continue knitting.

## WHAT TO DO IF THE NEEDLES ARE SELECTED INCORRECTLY.

Check the following points:

- Make sure that you have programmed the pattern correctly.
  - Make sure you have set the K-Carriage correctly and that you began with it outside a Turn Mark on the first row of the pattern.
  - Make sure the K-Carriage passed the centre of the machine (needle Green 1) on every row. If the Carriage is returned without passing the centre of the needlebed, the same needle selection will appear again. If this is what you have done wrong, correct the needle selection as follows:
- (1) Place all selected needles in B position.
  - (2) Push both PART Buttons and take the K-Carriage across to the other side of the needlebed. (The K-Carriage must pass the centre of the machine.
  - (3) Place any selected needles in B position.
  - (4) Take the K-Carriage across the needlebed again, this time to get the correct needle selection.
  - (5) Push the Cam Buttons according to your pattern, check the yarn in the Yarn Feeder and continue knitting.



## WHAT TO DO IF THE NEEDLES ARE NOT SELECTED AND REMAIN AT B POSITION.

Check the following points:

- Make sure you have set the K-Carriage correctly and that you began with it outside a Turn Mark on the first row of the pattern.
- Make sure that the READY Lamp is lit. If it isn't, check whether the program is finished or not.
- Should the SELECTOR Key be different? Check whether the pattern is made when SELECTOR (2) is on.
- When you began to pattern knit again after moving the K-Carriage outside the Turn Mark, did the K-Carriage pass the Turn Mark after setting the Change Knob to KC (I) or KC (II)?

If the K-Carriage didn't pass the Turn Mark, correct this as follows:

- (1) Unravel the knitting down to a correct row.
- (2) Place the K-Carriage outside the Turn Mark on the opposite side of the needlebed to the yarn end.
- (3) Set the Change Knob to KC (I) or KC (II) and push both PART Buttons.
- (4) Move the K-Carriage from outside the Turn Mark across the needlebed to select the needles.

## WHAT TO DO WHEN THE LETTER E IS FLASHING ON AND OFF IN THE MEMO DISPLAY.

- ① Push the CE Key to clear the Display.
- ② Enter the correct figure.

In the following cases, the E will flash on and off in the Memo Display.

- When you enter an unmemorized pattern number.
- When you enter a pattern position higher than Yellow 799 or Green 100.
- When you are programming your own pattern and enter a stitch number above 200 or a row number higher than can be knitted.
- When knitting in Lace Pattern — you enter 0 and push the CR Key or when you push the CR Key without moving the K or L Carriage after a correction.

## REPLACING A NEEDLE

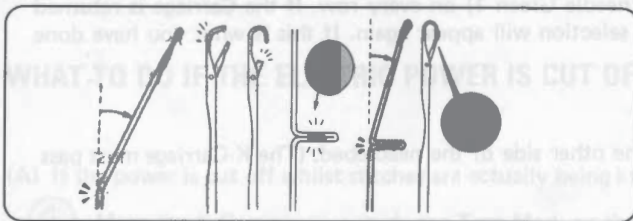

- Needles that are bent, broken or damaged will cause problems during knitting. If you experience dropped or badly knitted stitches you should check the needles and replace any faulty ones immediately. In an emergency if you have no spare needles, use one from the extreme edge of the needlebed.

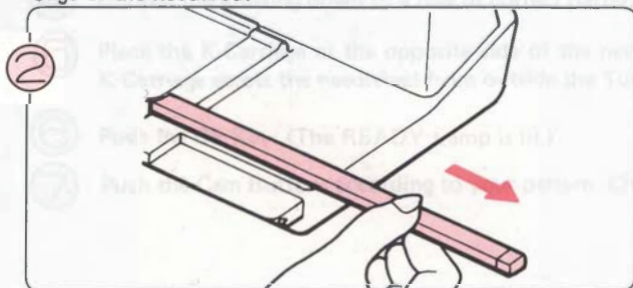

Draw the Bar out by hand until it passes the needle to be replaced.

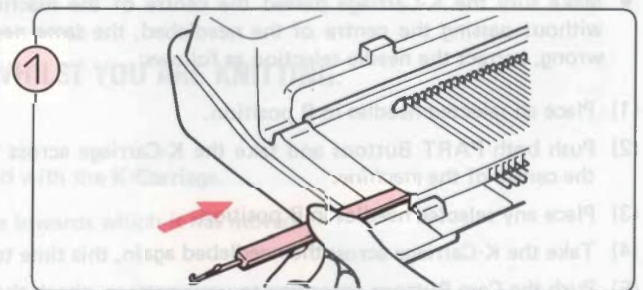

Push one end of the sponge Presser Bar with the handle of your Latchet Tool until it appears at the other end.

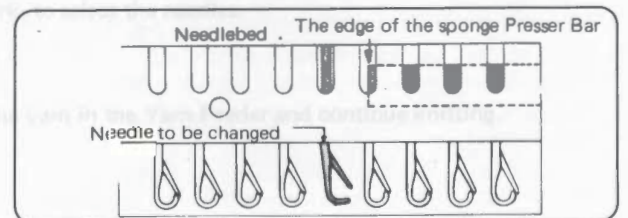

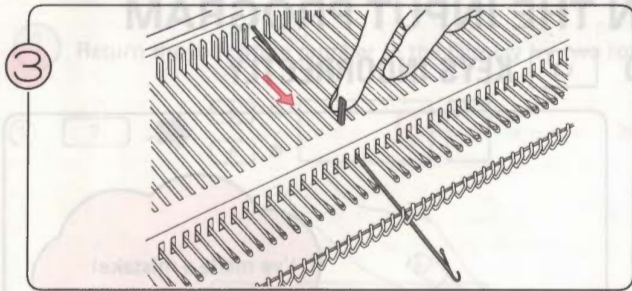

3 Push the faulty needle forward to E position as far as it will go.

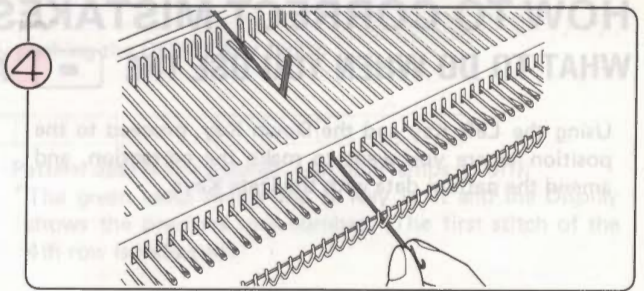

4 Press down at the hook end so that the shank end of the needle is raised clear of the needlebed.

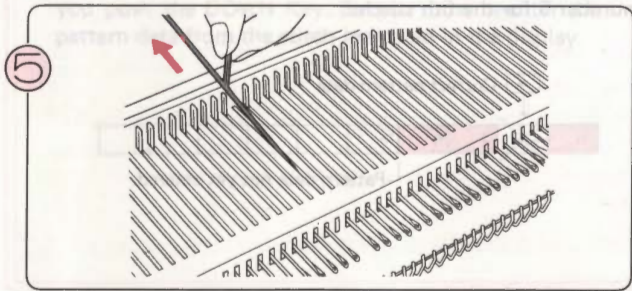

5 Catch hold of the shank end and lift the faulty needle out from the needlebed.

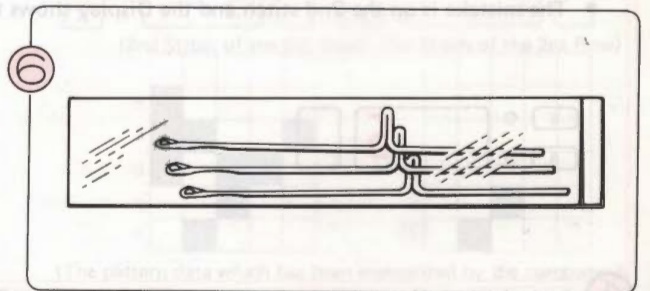

6 Take a spare needle out of the Accessory Box.

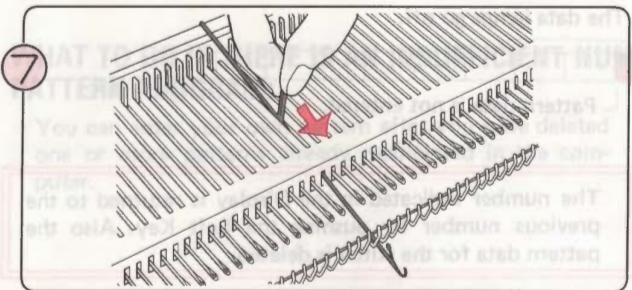

7 With the latch open, insert the new needle as shown.

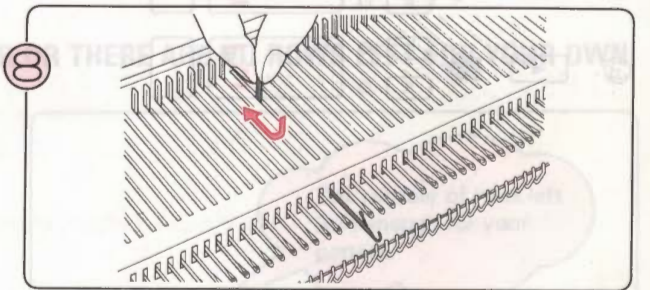

8 Return needle to A position.

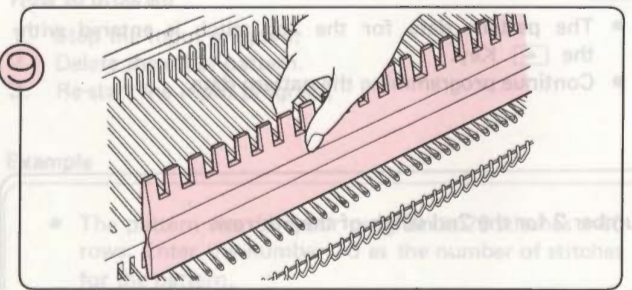

9 Holding the needles down with your hand or the flat side of your 1/1 Needle Pusher, push the sponge Presser Bar back in place.

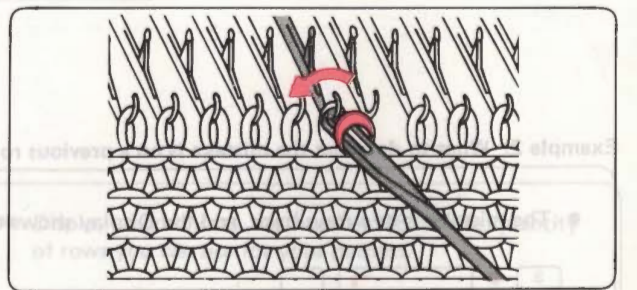

\* If you need to replace a needle whilst you have knitting on the machine, transfer the stitch from the faulty needle onto an adjacent needle. Replace the stitch after you have completed the replacement.

# HOW TO CORRECT MISTAKES IN THE INPUT PROGRAM

## WHAT TO DO WHEN YOU USE THE AND KEYS INCORRECTLY

Using the Left Key and the Down Key, proceed to the position where you want to make the correction, and amend the pattern data with the Data Keys.

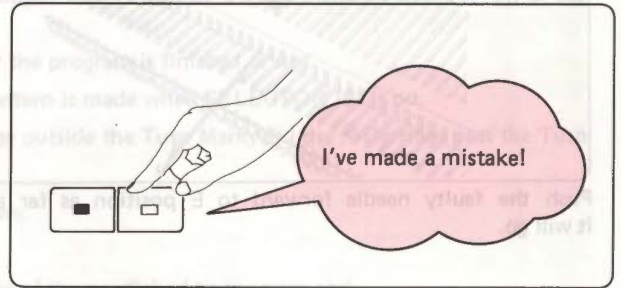

### Example 1: What to do when the mistake is on your current row.

- The mistake is on the 2nd stitch and the Display shows the number 5 for the 5th stitch.

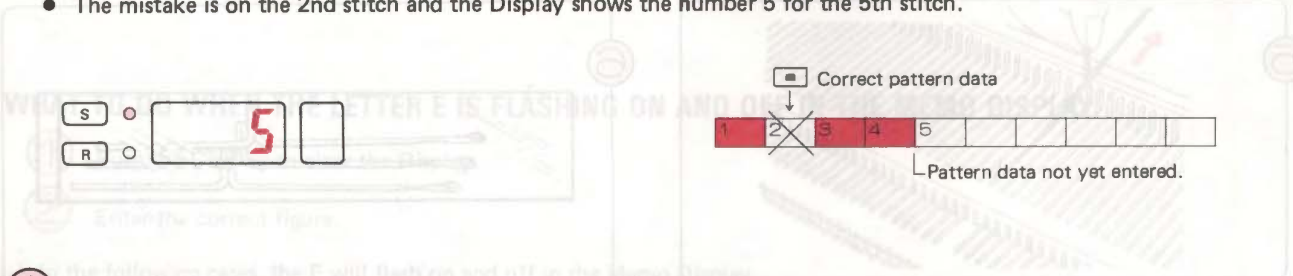

#### ① Push the Left Key until the Display shows the Number 2 for the 2nd stitch.

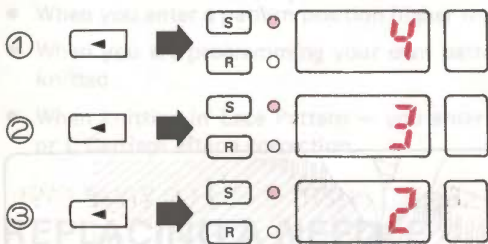

The data lamps go off.

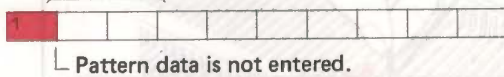

The number indicated in the Display is returned to the previous number by pushing the Left Key. Also the pattern data for the stitch is deleted.

#### ② Enter the correct pattern data for the 2nd stitch again.



- The pattern data for the 2nd stitch is entered with the  Key.
- Continue programming the pattern data.

### Example 2: What to do when the mistake is on a previous row.

- The mistake is two rows back, and the Display shows the number 2 for the 2nd stitch of the 5th row.

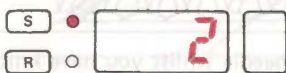

(2nd Stitch of the 5th Row)

① Return the indication number in the Display by two rows by pushing the DOWN Key twice.

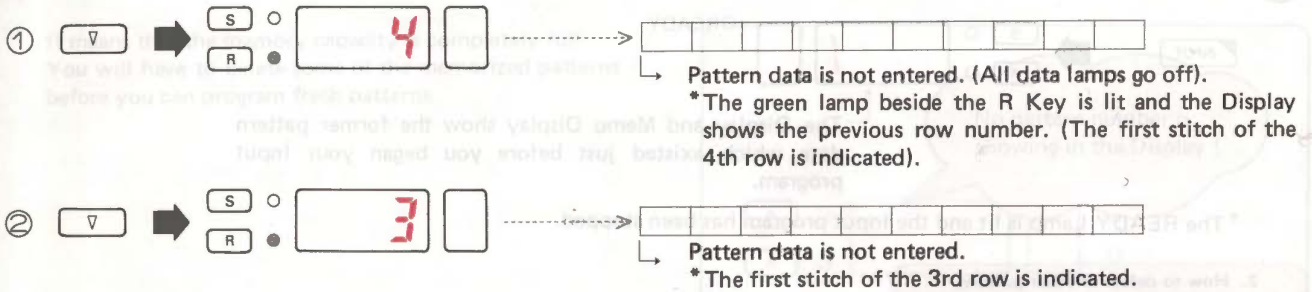

The pattern data is deleted from the computer when you push the DOWN Key. So you must re-enter the pattern data from the stitch indicated in the display.

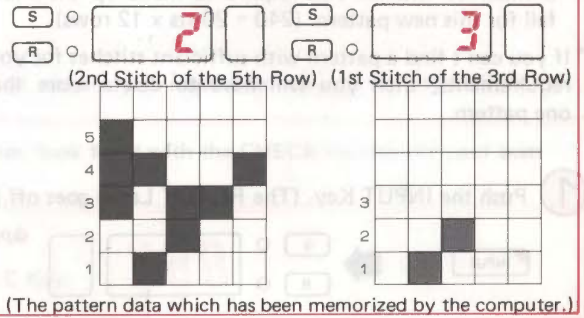

② Enter the correct pattern data for the first stitch of the 3rd row.

## WHAT TO DO IF THERE IS AN INSUFFICIENT NUMBER OR THERE ARE NO ROWS LEFT FOR YOUR OWN PATTERN PROGRAM.

You can enter your own pattern after you have deleted one or more patterns already memorized in the computer.

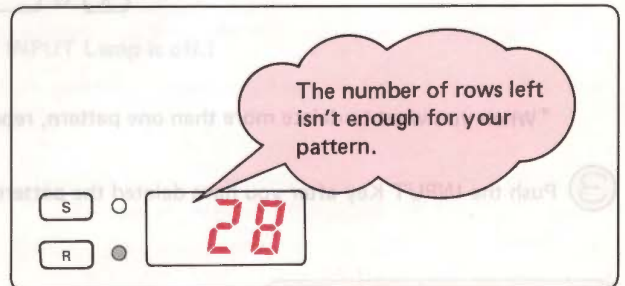

### How to program

1. Stop the Input program.
2. Delete the other pattern.
3. Re-start the Input program.

### Example

- The pattern size for your program is 20 stitches x 40 rows. Enter the number 20 as the number of stitches for the pattern.



The number of rows available for you to use. (You are 12 rows short of your required 40)

- Display then shows the number 28 as the quantity of rows you can use for your pattern.

### 1. Stop the Input program.

① Push the INPUT Key. (The INPUT Lamp goes off.)

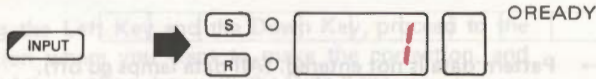

The Display and Memo Display show the former pattern data which existed just before you began your Input program.

\*The READY Lamp is lit and the Input program has been stopped.

### 2. How to delete another pattern.

Check back and find a pattern which has more than the number of stitches you require to make up the shortfall for this new pattern. (240 = 20 sts x 12 rows).

\*If you can't find a pattern with sufficient stitches for your requirements, then you will have to delete more than one pattern.

\*To find out how to check the memorized pattern, see "CHECK THE PATTERN DATA YOU HAVE STORED YOURSELF" on page 63.

① Push the INPUT Key. (The READY Lamp goes off.)



The Display shows the number which is used for the new pattern.

② Push the CE Key to clear the Display and enter the number of the pattern you want to delete, then push the C key.

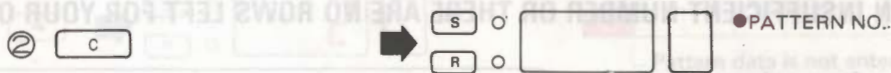
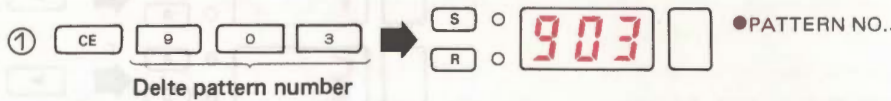

The number in the display together with all the pattern data for that number has been deleted from the computer.

\*When you want to delete more than one pattern, repeat Steps ① and ②.

③ Push the INPUT Key after you have deleted the pattern. (The INPUT Lamp is off.)

### 3. HOW TO INPUT PROGRAM

• Enter your own pattern program by referring to page 57.

Example 2: What to do when the mistake is on a previous row

Example

\* The pattern size for your program is 20 stitches x 12 rows. Enter the number 20 as the number of stitches for the pattern.

Example 2: What to do when the mistake is on a previous row

## WHAT TO DO WHEN THE DISPLAY DOESN'T INDICATE THE PATTERN NUMBER, EVEN IF THE INPUT KEY IS TURNED ON.

It means that the memory capacity is completely full. You will have to delete some of the memorized patterns before you can program fresh patterns.

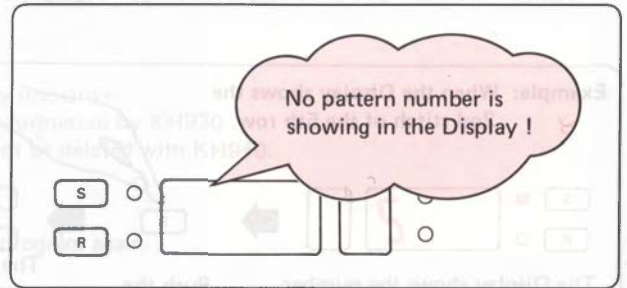

### 1. HOW TO DELETE THE MEMORIZED PATTERN

Check back and find a pattern which has more than the number of stitches you require to make up the shortfall for this new pattern.

\* If you can't find the pattern you want to delete from the computer, look for it with the CHECK routine for your own patterns on page 63.

① Enter the pattern number that you want to delete, and push the C Key.

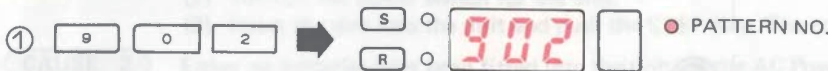

\* When you want to delete more than one pattern, repeat Steps ① and ②.

② Push the Input Key after you have deleted the pattern. (The INPUT Lamp is off.)

### 2. HOW TO INPUT PROGRAM

- Enter your own pattern program by referring to page 57.



## WHAT TO DO IF YOU WANT TO CHECK THE PATTERN DATA POSITION, WHILE YOU ARE ENTERING DATA.

① Push the INPUT Key. (The INPUT Lamp goes off.)

- You can check the pattern data position by changing the indication in the display with the R Key or the S Key.

**Example:** When the Display shows the 2nd stitch of the 5th row.

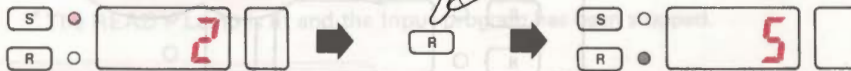

The Display shows the number 2 as the stitch number.

Push the R Key.

The Display changes to show number 5 as the row number, so you can check this.

\*When you push the S Key, the Display shows the stitch number again.

## WHAT TO DO IF THE ELECTRIC POWER IS CUT OFF WHILST YOU ARE ENTERING PATTERN DATA.

- When the electric power is cut off while you are using the Input Program, follow the instructions according to the Step you have reached.

### INPUT PROGRAM STEPS

- Turn on the INPUT Key.
- Push the STEP Key.
- Enter the number of stitches for the pattern.
- Push the STEP Key.
- Enter the number of rows for the pattern.
- Push the STEP Key.
- Enter the pattern data using the and Keys.

①

②

① What to do if the electric power is cut off while entering the Input program during Steps 1 to 5.

- The pattern data will revert back to the way it was just before you turned on the INPUT Key. Turn on the electric power and push the INPUT Key to activate it again. Enter the Input program from the beginning.

② What to do if the electric power is cut off when pushing the STEP Key at Step 6, after you have entered the number of rows for the pattern, or while entering pattern data with the Data Key at Step 7.

- All the pattern data entered before the power was cut off is memorized in the computer correctly. But the data for the rest of your pattern stitches will have been automatically entered as key stitches by the computer.

(1) If the pattern data programming is nearly finished, use the CHECK program to correct the Key entries for the remainder of the stitches. Please refer to page 63.

(2) If you had only just started pattern data programming, delete the pattern data and begin the Input program again.

1. Turn on the electric power.

2. Push the INPUT Key (on) and push the CE Key to clear the indication in the Display. Enter the pattern number you want to delete and push the C Key. Turn off the INPUT Key.

3. Push the INPUT Key (on) and enter the pattern data from the beginning again.

# WHEN USING FLOPPY DISC DRIVE

## WHAT TO DO WHEN AN ERROR MESSAGE APPEARS

### • ERROR MESSAGE

#### MESSAGE NO. 0

##### CAUSE

The disc formatted with KH930 is set in the floppy disc drive.  
Pattern data of KH940 cannot be saved in the disc formatted by KH930.  
Pattern data in the disc formatted by KH930 cannot be deleted with KH940.

##### SUGGESTED ACTION 1: Set the appropriate disc.

- (1) Change the disc.
- (2) Push the STEP key. The computer begins the program again.

##### SUGGESTED ACTION 2: Finish the program.

- (1) Remove the disc from the unit.
- (2) Turn off the power switches for both the disc drive unit and the knitting machine.

##### SUGGESTED ACTION 3: With KH940 format the disc formatted by KH930 and save the pattern data again.

\* In this case all the pattern data of KH930 is deleted.

- (1) Turn off the power switch for the knitting machine.
- (2) Turn on the power switch again and format the disc.
- (3) After formatting is completed, save the pattern data.

#### MESSAGE NO. 1

##### CAUSE 1

The floppy disc drive power switch is not on.

##### SUGGESTED ACTION:

- (1) Remove the disc from the unit.
- (2) Turn on the power switch for the unit.
- (3) Insert the disc into the unit and push the STEP Key. The computer begins programming again.

##### CAUSE 2

Either no batteries have been fitted into the unit, or the AC Power adaptor is not connected.

##### SUGGESTED ACTION:

- (1) Remove the disc from the unit.
- (2) Turn off the power switches for both the disc drive unit and the knitting machine.
- (3) Fit the appropriate batteries into the unit or connect the AC Power adaptor.
- (4) Turn on the power switches for both the disc drive unit and the knitting machine.
- (5) Insert the disc into the unit and start the program again.

##### CAUSE 3

The interface cable is not connected.

##### SUGGESTED ACTION:

- (1) Remove the disc from the unit.
- (2) Turn off the power switches for both the disc drive unit and the knitting machine.
- (3) Connect the interface cable securely.
- (4) Turn on the power switches for both the disc drive unit and the knitting machine.
- (5) Insert the disc into the unit and start the program again.

#### MESSAGE NO. 2

##### CAUSE

Floppy disc is not working correctly.

##### SUGGESTED ACTION:

- (1) Remove the disc from the unit.
- (2) Turn off the power switches for both the disc drive unit and the knitting machine.
- (3) Now turn on the power switches for both the disc drive unit and the knitting machine, and insert the disc into the unit.
- (4) Start the program again.

If the Memo Display shows Error Message No. 2 again, there is a defect in the floppy disc drive.  
Have the unit checked by your service dealer.

#### MESSAGE NO. 3

##### CAUSE

The disc is not inserted into the unit.

##### SUGGESTED ACTION:

Insert the disc into the disc drive unit and push the STEP Key. The computer begins the program again.

#### MESSAGE NO. 4

**CAUSE** The disc is write-protected.

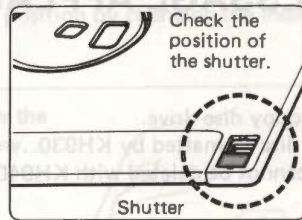

When the shutter is closed, the disc is not write-protected.

When the shutter is open, the disc is write-protected.

When the shutter is up and the hole is closed, you can write data onto the disc.

When the shutter is down and the hole is open, you cannot write data onto the disc, and the existing data is protected from accidental erasure.

#### SUGGESTED ACTION:

- (1) Remove the disc from the unit. Cancel the write-protect setting.
- (2) Replace the disc into the unit and push the STEP Key. The computer starts the program again.

#### MESSAGE NO. 5

**CAUSE** You are trying to use a disc that has not been formatted.

**SUGGESTED ACTION 1:** Use this disc again after you have formatted it.

- (1) Turn off the power switch for the knitting machine to finish the program.
- (2) Turn on the power switch for the knitting machine.
- (3) Now format the disc.

**SUGGESTED ACTION 2:** Use another disc which has already been formatted.

- (1) Exchange the disc for one that has been formatted.
- (2) Push the STEP Key. The computer starts the program again.

#### MESSAGE NO. 6

**CAUSE** Pattern data is not saved on the track number you programmed.

**SUGGESTED ACTION 1:** Re-enter another track number.

- (1) Push the CE Key to clear the error message from the Memo Display.
- (2) Enter the new track number.
- (3) Push the STEP Key again. The computer starts the program again.

**SUGGESTED ACTION 2:** Finish the program.

- (1) Push the CE Key to clear the error message from the Memo Display.
- (2) Push the STEP Key.

#### MESSAGE NO. 7

**CAUSE 1** The face of the programmed track has a flaw in it.

- If the flaw is on only part of the disc, you can't use that track, but you can use the remaining tracks.
- If the flaw is across the whole face of the disc, none of the tracks can be used.

**CAUSE 2** The pattern data on the programmed track has been affected by magnetism.

- If the pattern data is only partly broken, you cannot use this track, but you can use the other tracks.
- If all the pattern data are affected, you can only use the disc after you have formatted it again.

● **When finishing the program:—**

- (1) Push the CE Key to clear the error message in the Memo Display.
- (2) Push the STEP Key.

**NOTE:** Please refer to the leaflet accompanying the Floppy Disc Drive Unit or the blank discs for how to handle the discs.

## MESSAGE NO. 8

**CAUSE** There is no space left on the disc to save the pattern data.

**SUGGESTED ACTION 1:** Use this disc again after you have formatted it.

- (1) Turn off the power switch for the knitting machine to finish the program.
- (2) Turn on the power switch for the knitting machine.
- (3) Now format the disc.

**SUGGESTED ACTION 2:** Use this disc again after you have deleted one of the memorised patterns you no longer want to save.

- (1) Turn off the power switch for the knitting machine to finish the program.
- (2) Turn on the power switch for the knitting machine.
- (3) Now delete the pattern.

**SUGGESTED ACTION 3:** Use another empty or partly-empty disc which has already been formatted.

- (1) Exchange the disc for one which is already formatted.
- (2) Push the STEP Key. The computer begins to save the data.

## MESSAGE NO. 9

**CAUSE 1** You cannot format a disc because it is defective.

**SUGGESTED ACTION 1:** Use another disc.

- (1) Exchange the faulty disc for a fresh one.
- (2) Push the STEP Key. The disc will now be formatted.

**SUGGESTED ACTION 2:** Finish the program.

- (1) Remove the faulty disc from the unit.
- (2) Turn off the power switch for the knitting machine to terminate the formatting.

**CAUSE 2** You cannot save your pattern data because the disc is defective.

**SUGGESTED ACTION:** Use another disc which has already been formatted.

- (1) Exchange the disc for one that has been formatted.
- (2) Push the STEP key. The computer starts saving your pattern again.

\*When an error message is indicated in the Memo Display, you can stop the program by turning off the power switch for the knitting machine.

## IF THE LOW BATTERY ALARM LAMP IS LIT (WHILST USING THE BATTERIES)

As soon as the batteries become weak, you should change them for new ones.

\*When the batteries are exhausted, the power is cut off automatically, and you cannot program. Start the program again after you have replaced the batteries.

Even if the power is cut off, the data on the discs is not lost.

\*As you turn off the power switch for the unit, the low battery alarm lamp is lit for a short time. That is correct, and is not a fault.

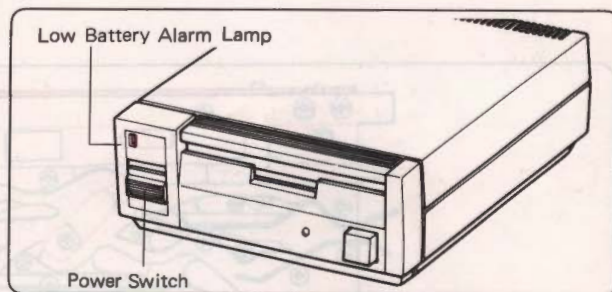

## WHAT TO DO IF YOU WANT TO COPY A PATTERN FROM ONE DISC ONTO ANOTHER.

Perhaps you have borrowed a disc from a friend and you want to copy one of the patterns.

- First you must transfer the pattern from your friend's disc into your knitting machine computer. (See p. 76 "How to load your pattern data".)
- Next, remove your friend's disc, and insert one of your own that has been formatted (See p. 74 "How to format your discs"), and that has sufficient space to store all or part of the pattern.
- Now transfer the pattern from the computer memory onto your disc. (See p. 75 "How to save your pattern data".)

You now have a copy of your friend's pattern on your own disc.

## CLEANING AND MAINTENANCE

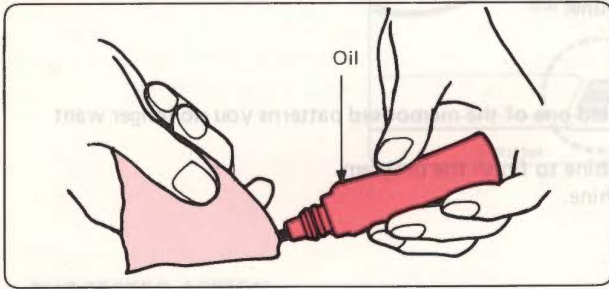

Wipe the metal parts with an oily cloth and clean plastic parts with a soft cloth and mild, neutral detergent.

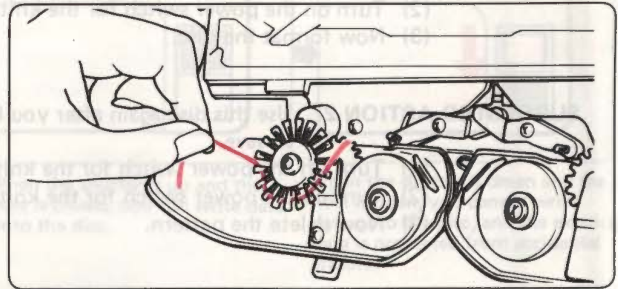

Remove the K and L Carriages from the needlebed and brush away any dust or fluff. Check that the brushes are free from fluff or strands of yarn, and that they revolve smoothly.

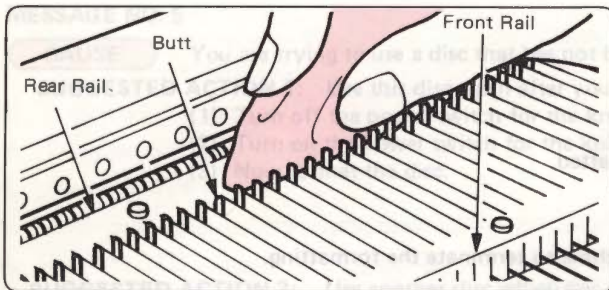

Arrange all needles in B position and clean the butts, rear and front rails as shown, using an oily cloth.

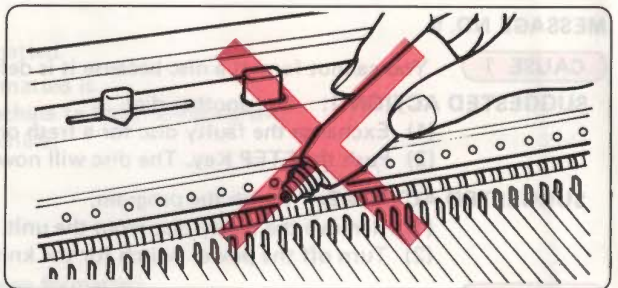

Do not put oil directly onto the machine.



Do not use alcohol, benzine, thinners or petrol.

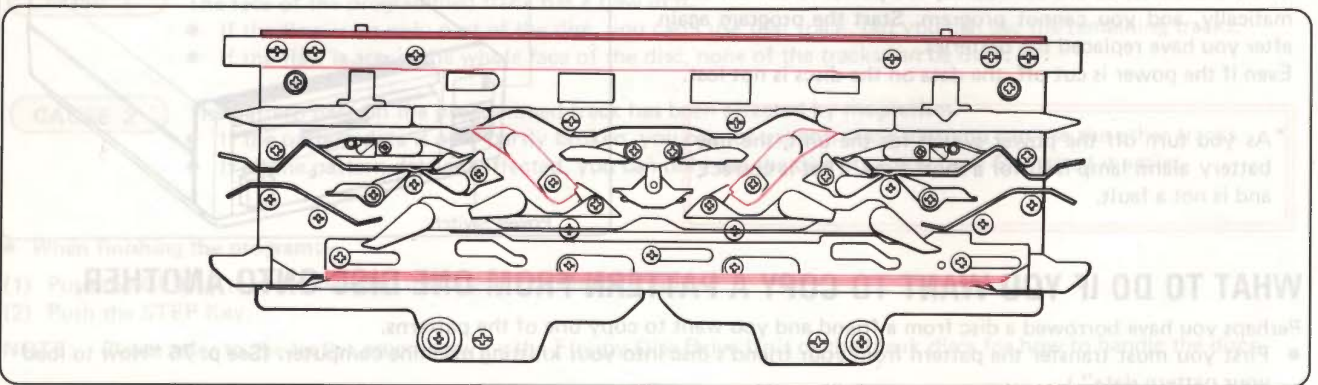

Should the K-Carriage feel heavy to operate, you should clean and lubricate the areas indicated above, using an oily cloth. If you regularly clean and lightly oil your machine it will make knitting easier and help to prevent excessive wear.

When you come to use your machine again after you have stored it for a while, knit 20 – 30 rows with waste yarn to clean away any dirty oil.

