

How to use your

Knit-Leader

KL-116

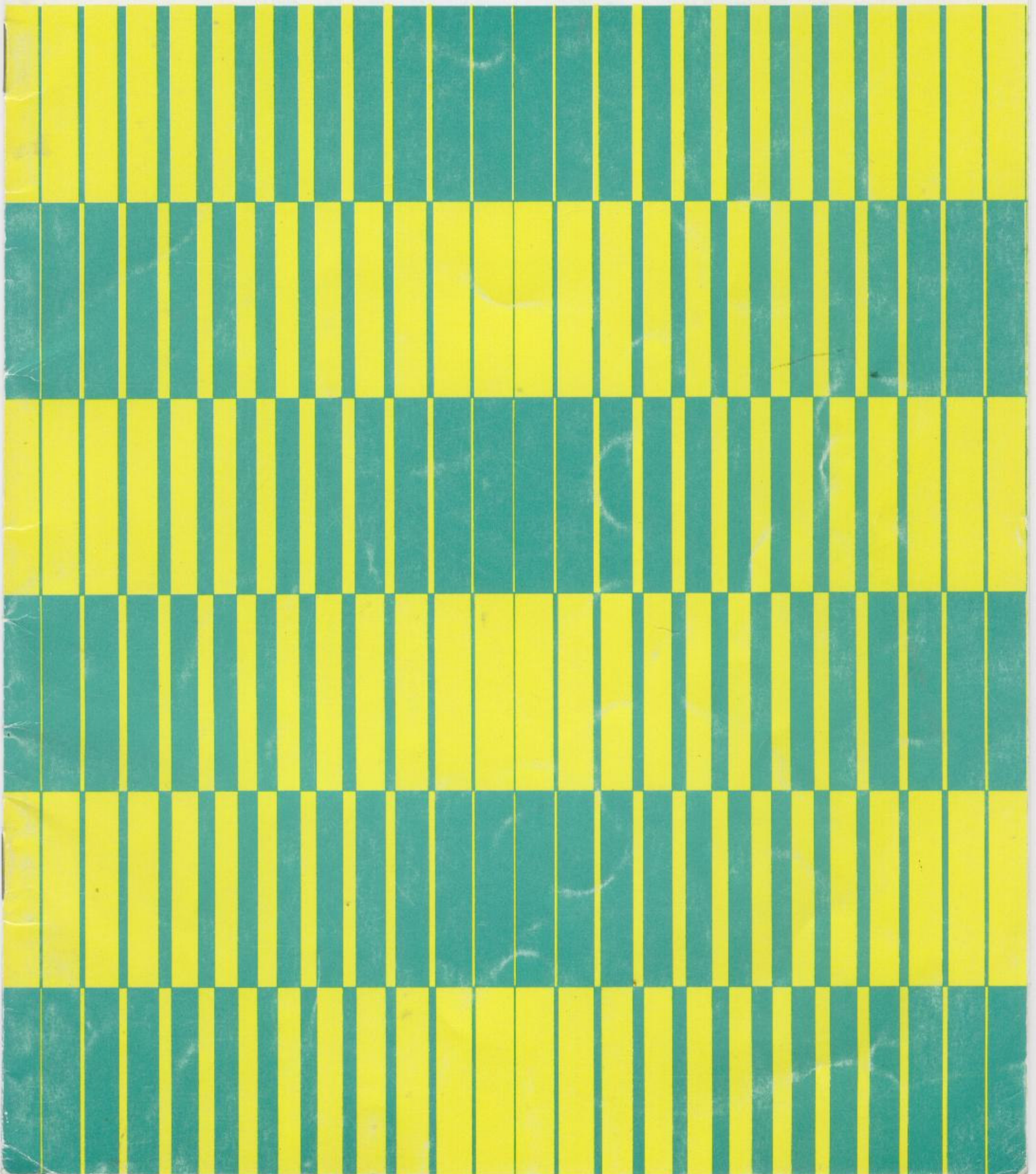

IMPORTANT

When you use the Knit-leader KL-116 with KH-120 fine gauge knitting machine:

The way to determine knitting gauge- Please measure knitting gauge in the same way as KH-830/840 as shown in the page 7 but because of narrower needle pitch of KH-120 than KH-830/840, there are some exceptions as follows:

EXAMPLE

Width of 40 stitches is 75 mm

KL-116 Stitch measure scales cover width of 40 stitches from 80 mm to 180 mm. So, in this case, please double the above width first, then select the measure scale as follows;

$$75 \text{ mm} \times 2 \text{ times} = 150 \text{ mm}$$

Select No. 17 measure scale referring to the table on the page 8.

But, please note that in case of decreasing or increasing stitch, Two graduations on the scale are equivalent to one stitch(needle).

Length of 60 rows is 5.6 cm

Regulator for cm and mm covers length of 60 rows from 6.0 cm to 20.9 cm. So, in this case, please double the above length and set the Regulator as follows;

$$5.6 \text{ cm} \times 2 \text{ times} = 11.2 \text{ cm}$$

Set the regulator for cm: 11

Set the regulator for mm: 2

At the same time, set the connecting pin into the right side hole as shown in the illustration, so that you can obtain proper knitting.

This method also applicable to the special knitting gauge like the TUCK stitch pattern which length of 60 rows is less than 6.0 cm.

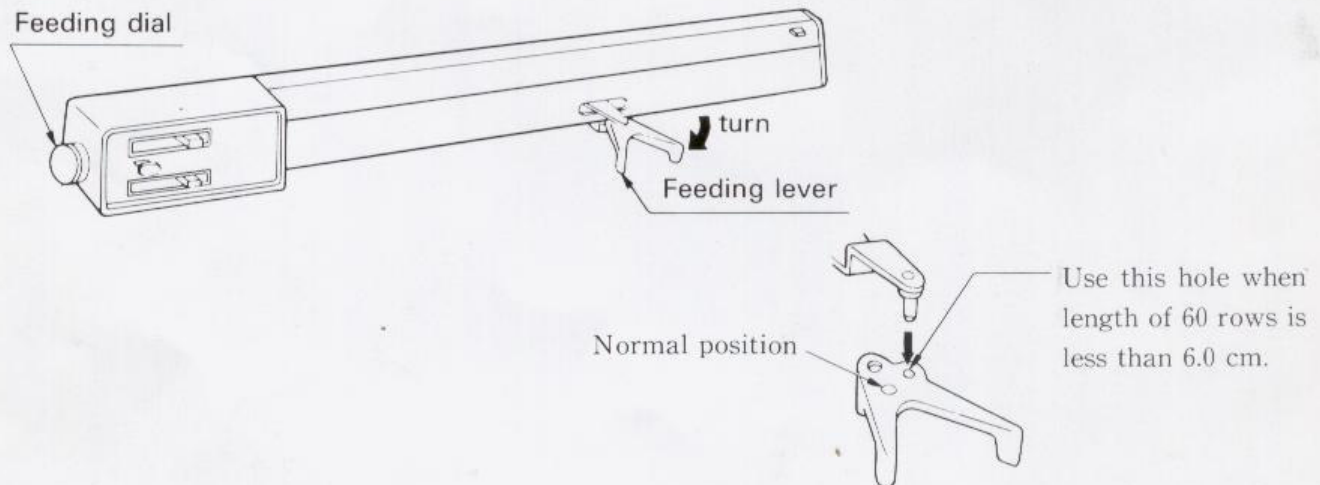

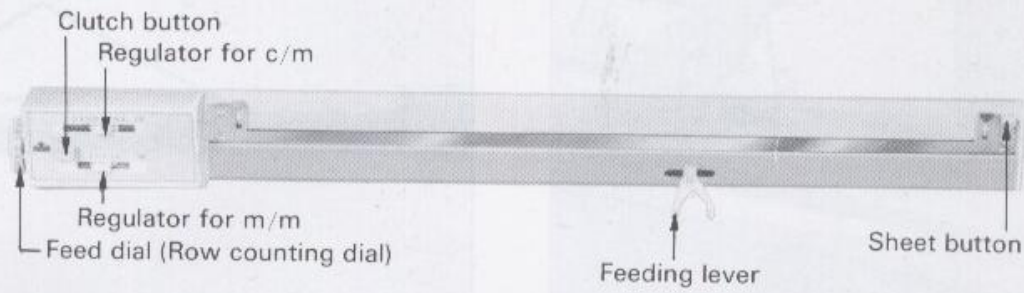

Sheet



Stitch measure scale



Sheet case



Sheet guides



Setting plates



Ruler

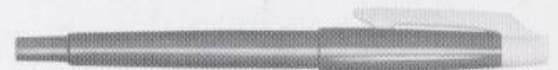

Felt pen (Black)

Binding wire

Installing the Knit-leader

2

1. Pull out both setting plates.

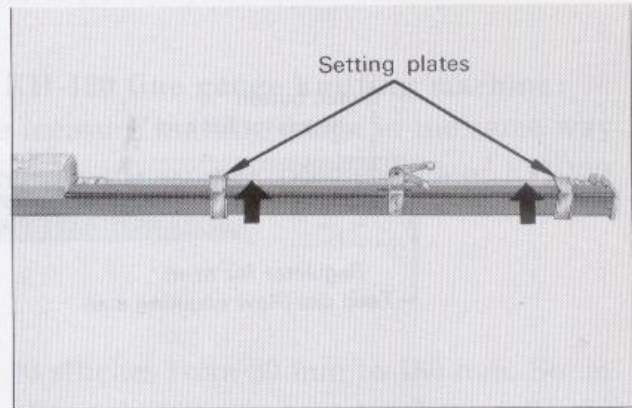

2. Insert the Setting plates in each setting plate holder.
And Turn out the Feeding lever.

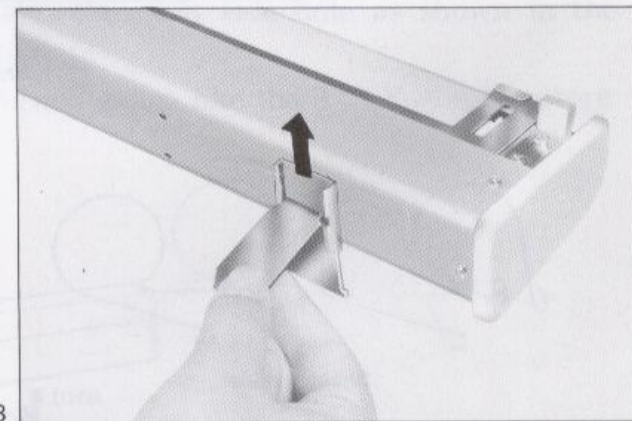
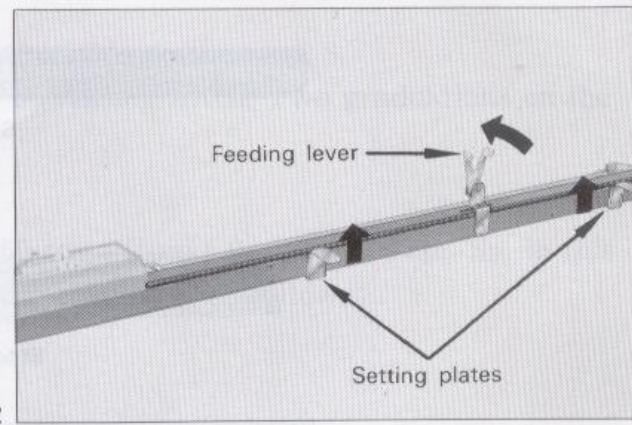

3. Insert the setting plates into the slots at the back of the knitter.

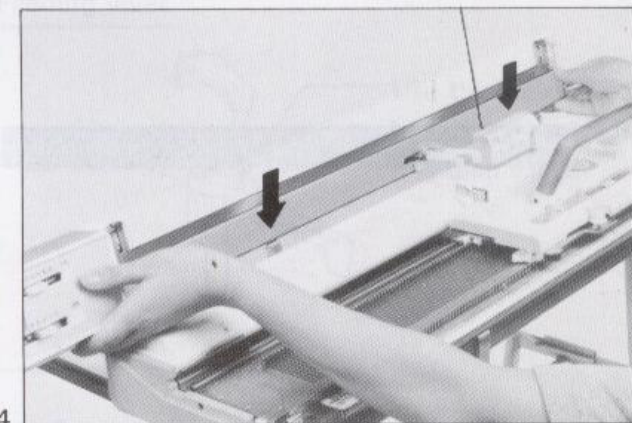

4. Insert the Sheet guides (one each at right and left) to the back of the Knit-leader.

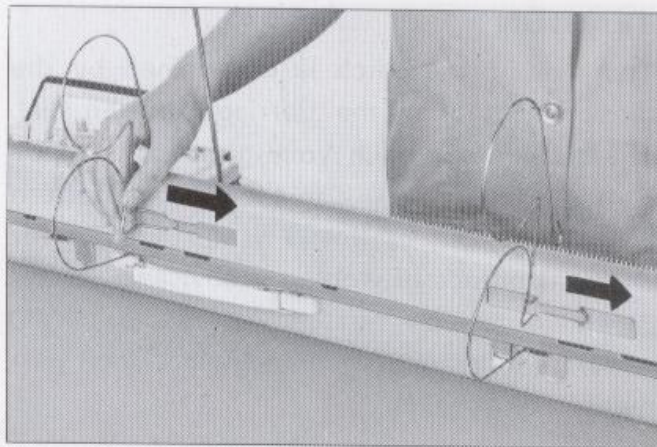

5

5. Now you have finished to set up the Knit-leader to the knitter.

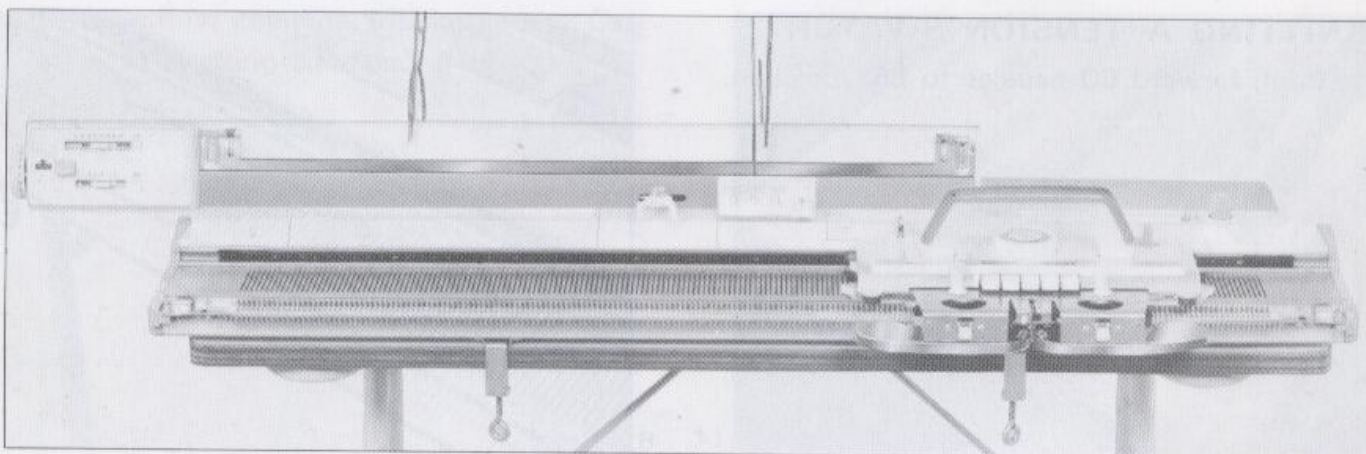

6

Tension the Knit-leader

Knitting a tension swatch

4

TENSION

The size of the stitch is determined by the tension setting on the Carriage tension dial. The tension at which your garment is to be knitted is usually given in the knitting pattern instructions, but as this is liable to differ for different brands of wool, it is advisable always to knit a tension swatch (40 stitches \times 60 rows) sample before commencing your garment.

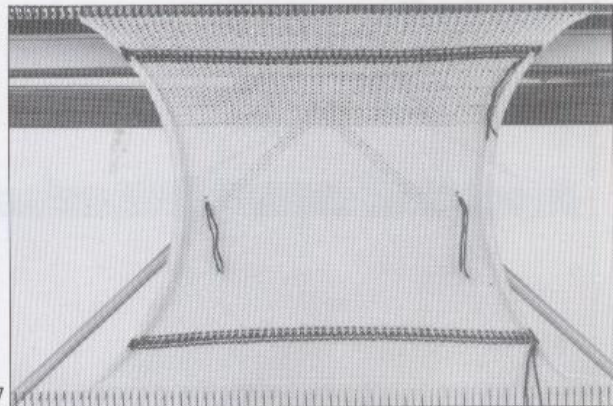

KNITTING A TENSION SWATCH

1. Bring forward 60 needles to "B" position.

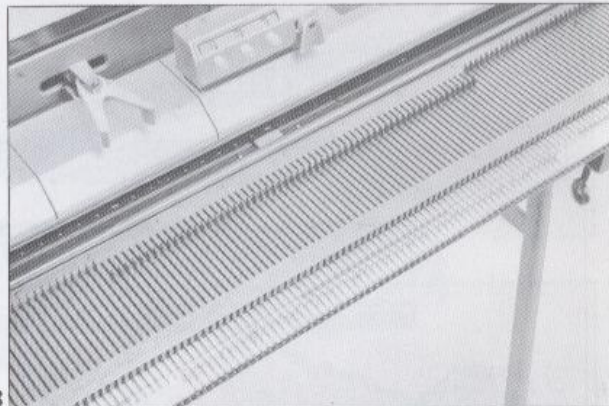

2. Using the Cast-on comb, knit 60 stitches across and about 10 rows of them. Then knit two rows using a different colour of yarn.

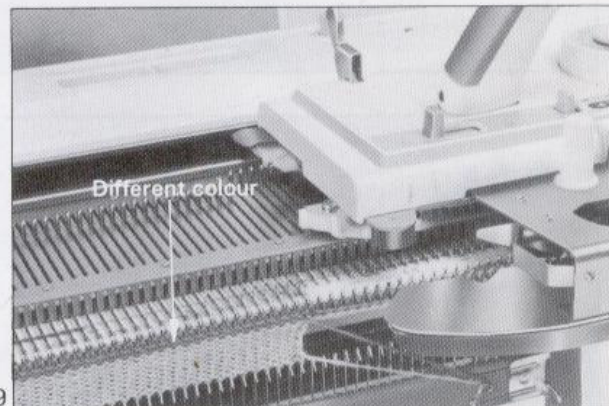

3. After knitting, set the Row counting dial to the number "0".



10

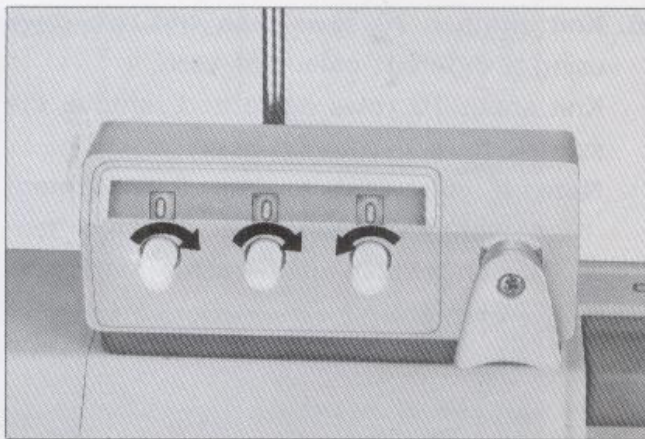

A row counting dial in plain stock

4. Set the Row counting tripper on the Carriage to working position.

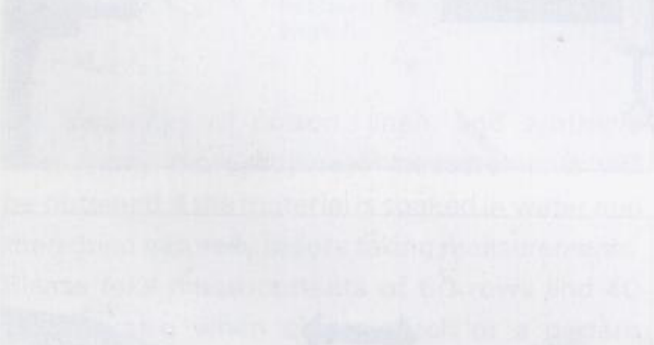

11

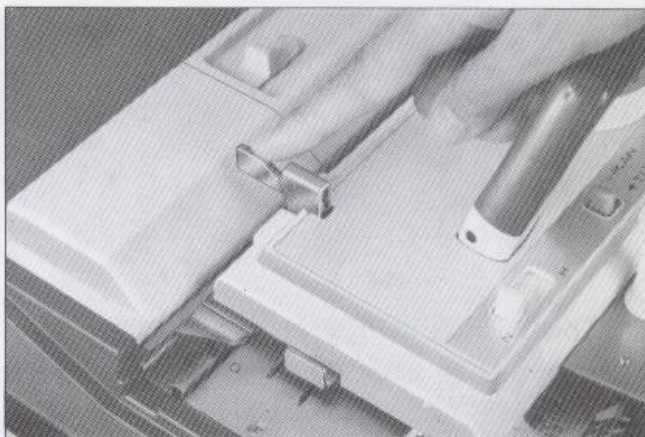

5. Knit 30 rows with the original yarn, then bring forward both 21st needles from the center to "E" position.

Hook the separate yarn into the hook of these needles, and make the stitch as shown in the Fig. 12.



12

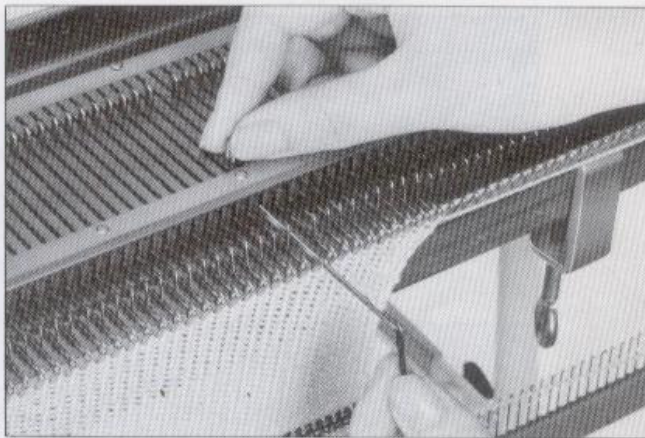

A row counting dial in plain stock

6. Knit another 30 rows then knit two rows using a different colour of yarn.

Knit about 10 rows again and remove the swatch from the knitter.

Note: If you want to knit the Garment with Pattern Stitches, make a tension swatch of the same pattern as Garment.

13

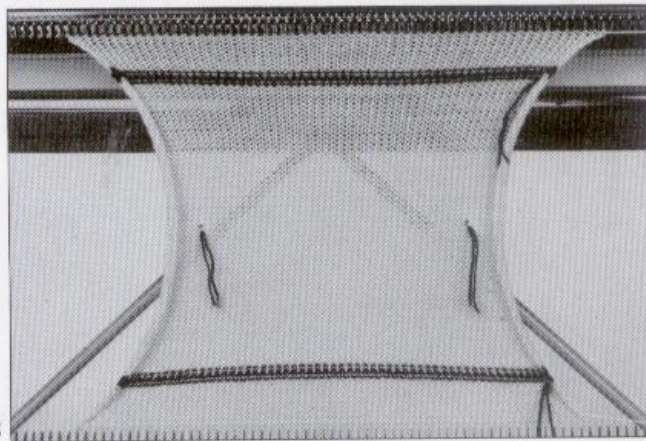

14

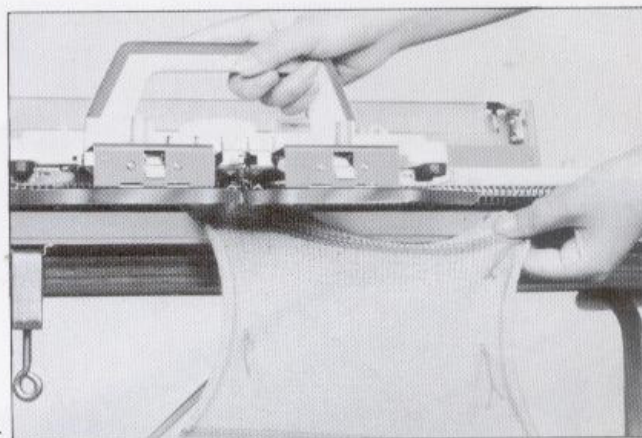

7. This swatch is in stretched condition right after it has been knitted and must be restored to its natural state by following the steps mentioned below.

(1) Stretch the swatch longitudinally two or three times. (Fig. 15)

15

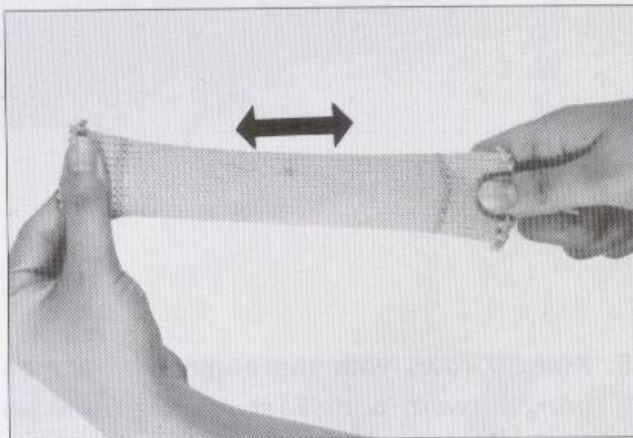

(2) Pat lightly with your hands to restore the stretched stitches.

16

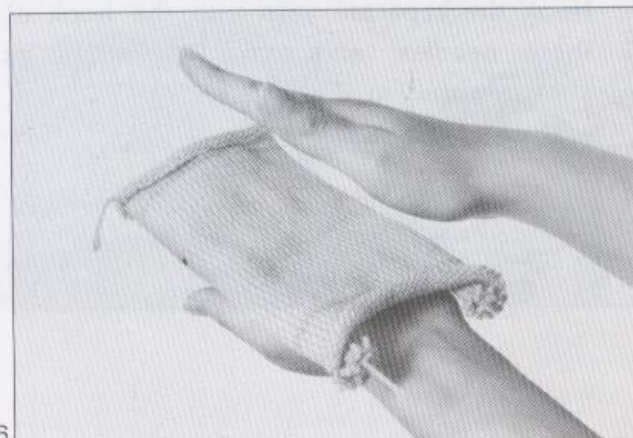

How to Determine Knitting Gauge

In order to knit according to the correct size of your pattern, please measure the tension swatch accurately.

- (1) Measure the height of 60 rows in centimeters, (inside the two lines knitted with a different color).
- (2) Measure the width of 40 stitches in centimeters. If the material used is pure wool, please apply steam to the swatch with a steam iron before taking measurements.

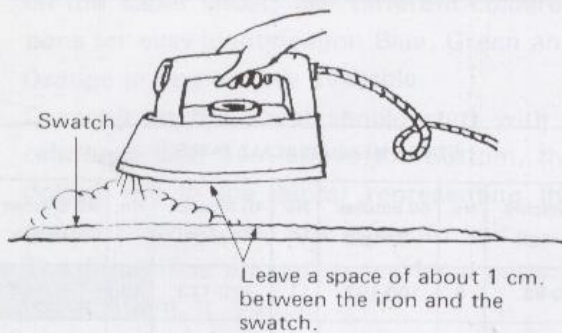

For swatches of cotton, linen, and synthetic fiber yarn, more accurate measurements will be obtained if the material is soaked in water and then dried naturally before taking measurements. Please take measurements of 60 rows and 40 stitches also when a lace stitch or a pattern stitch is used.

For better accuracy it is preferable to take the above-mentioned measurements at 3 different places on the swatch and use the average figure.

17

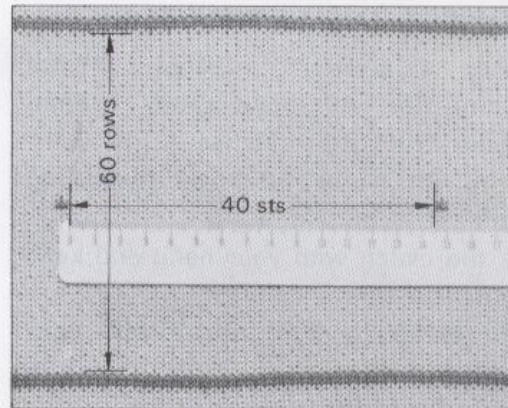

A tension swatch in plain stitch

18

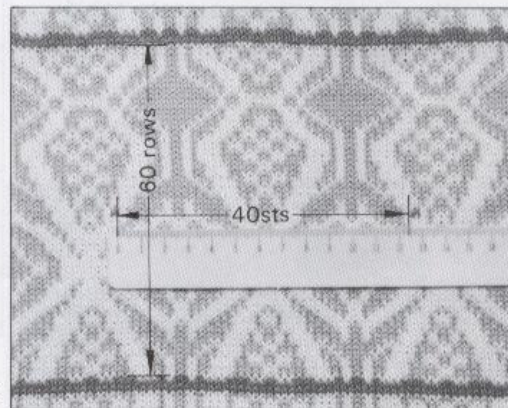

A tension swatch in pattern stitch

19

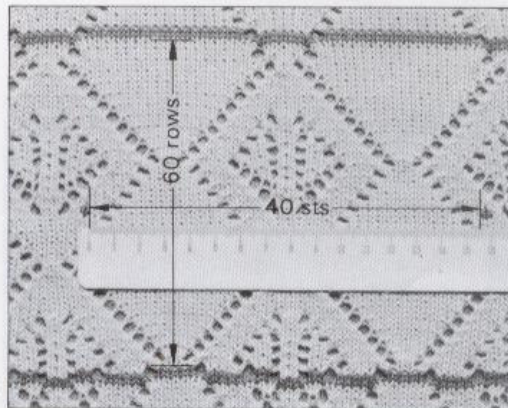

A tension swatch in lace stitch

How to set the Regulators and Measure scale

8

HOW TO SET THE REGULATORS

* Suppose a swatch measures 138mm (13.8cm) for 60 rows and 146mm (14.6cm) for 40 stitches.

A. How to set it for 60 rows measuring 138mm (13.8cm). Fig. 20.

- (1) Press the clutch with your hand and keep it there.
- (2) Set Regulator for c/m to 13 with your right hand.
- (3) Then set Regulator for m/m to 8.

* The clutch button will be released automatically as soon as knitting is started.

B. How to set it for 40 stitches measuring 146mm(14.6cm).

- (1) Refer to the Stitch measure scale table pasted on the Sheet case.

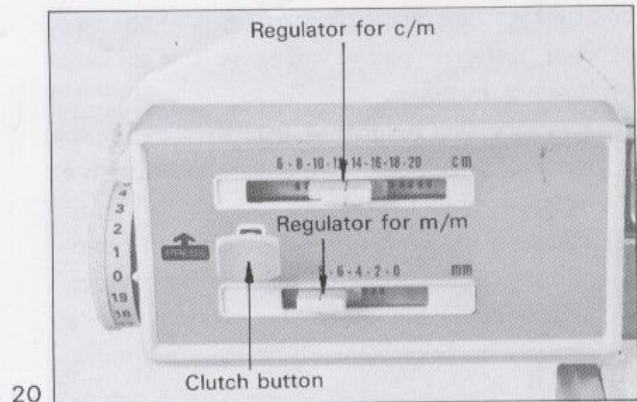

20

No.	40 Stitches Length	No.	40 Stitches Length	No.	40 Stitches Length	No.	40 Stitches Length
1	80-83	6	100-103	11	120-123	16	142-148
2	84-87	7	104-107	12	124-127	17	150-156
3	88-91	8	108-111	13	128-131	18	158-164
4	92-95	9	112-115	14	132-135	19	166-172
5	96-99	10	116-119	15	136-140	20	174-180

21

- (2) For 146mm(14.6cm), see the column which covers the figure 146, and you will see that 146mm(14.6cm) is represented by "No. 16 of Pink".

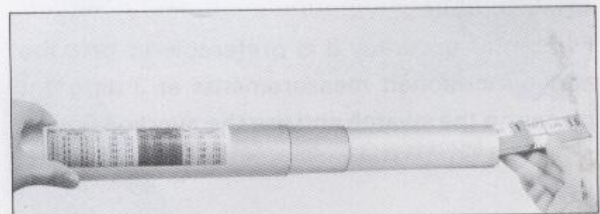

22

C. Take out "No. 16 of Pink" scale and set it to the Knit-leader. Fig. 23.

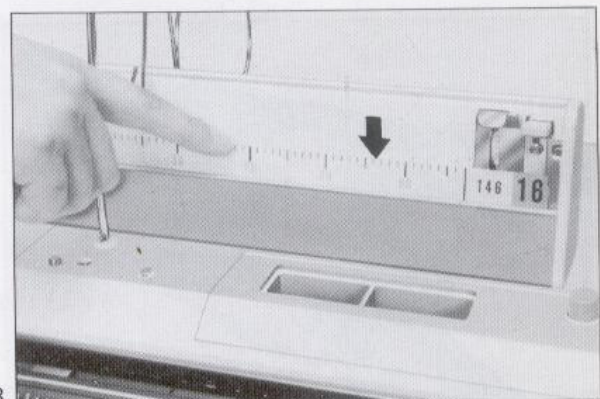

23

Pattern drawing on the Sheet

How to insert the Sheet

9

PATTERN DRAWING ON SHEET

1. A pattern is to be drawn on the sheet in actual size.
2. Use the special Felt pen included in the Sheet case for drawing.
3. If a line or lines must be erased, wipe the sheet gently with a wet cloth.
4. Wait until the sheet is dry again before redrawing a line or lines.
5. In case of drawing more than one pattern on the same sheet, use different-coloured pens for easy identification Blue, Green and Orange in one set are available.
6. Drawing on the sheet should start with a reference line, 5cm above the bottom, the dotted line in the center representing the center of what you are going to knit.
7. The Sheet has enough space for a pattern up to 60cm × 104cm.

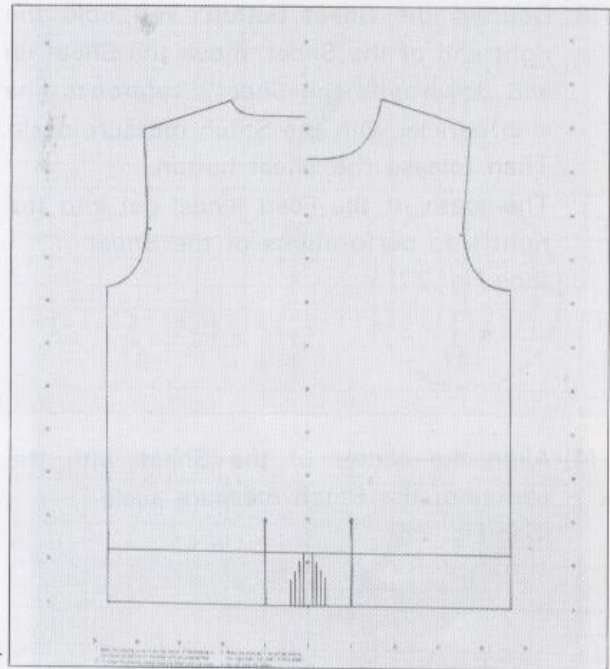

24

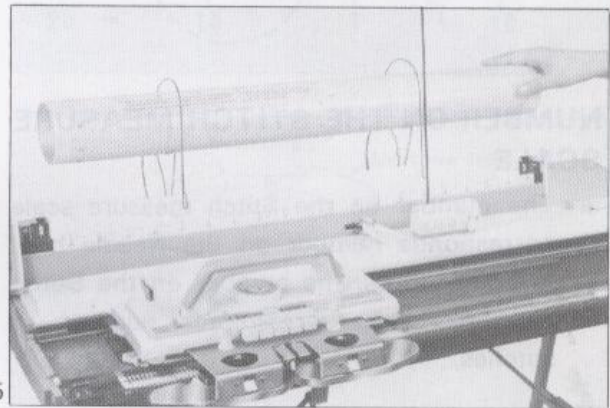

25

HOW TO INSERT THE SHEET

- (1) Insert the Sheet into the Sheet guides as shown in the Fig. 25.
- (2) Hold the left end of the Sheet with your hand and fit the Sheet's perforations over the teeth of the left Feed wheel. Turn the Feed dial 2 or 3 pitches.

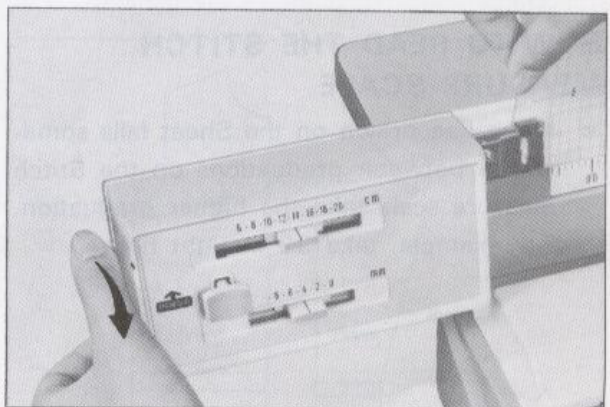

26

How to read the Stitch measure scale

10

- (3) Depress the Sheet button, and hold the right end of the Sheet, move the Sheet up and down until the Sheet's reference line is in parallel with the Stitch measure scale. Then release the Sheet button. The teeth of the Feed wheel get into the right side perforations of the Sheet. (See Fig. 27)

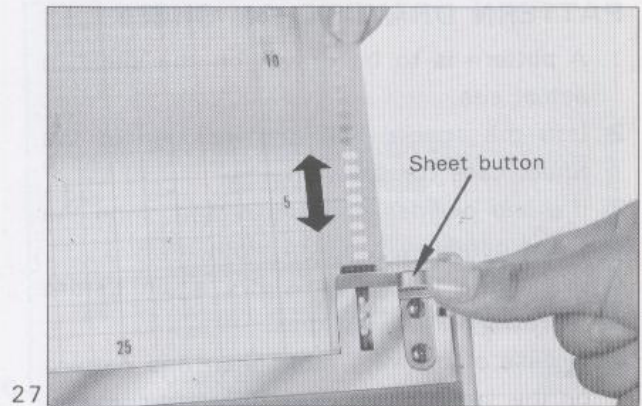

- (4) Align the center of the Sheet with the center of the Stitch measure scale. (See Fig. 28)

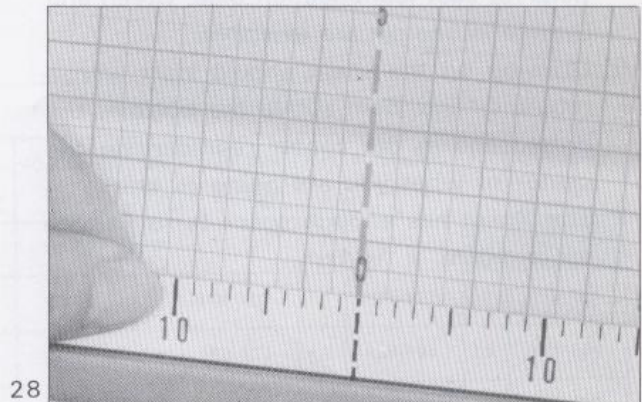

NUMBER ON THE STITCH MEASURE SCALE

- * The number on the Stitch measure scale corresponds number on the Needle bed. In other words, the number on the Stitch measure scale corresponds number of stitches.

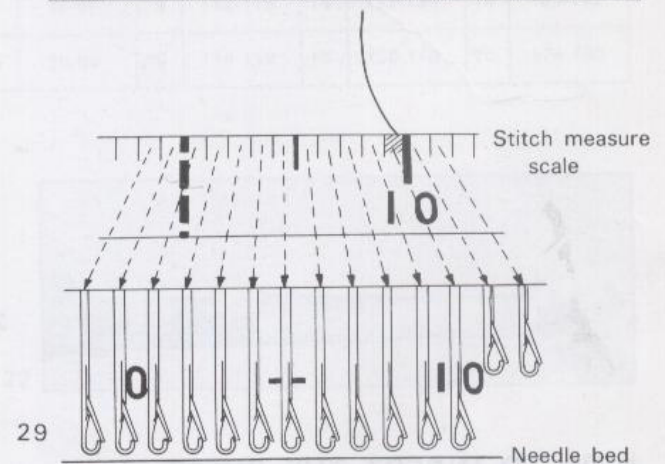

HOW TO READ THE STITCH MEASURE SCALE

- * If the line drawn on the Sheet falls somewhere between graduations on the Stitch measure scale take the higher graduation. For example, take 52 in right figure.

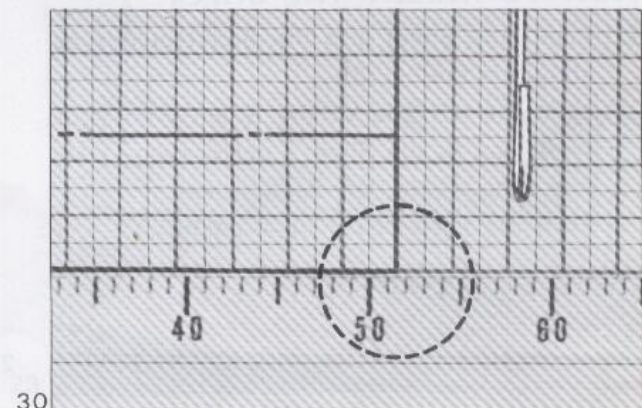

Procedure of making the garment

11

- * Take 11 in Fig. 31 and take 9 in Fig. 32.
- If the line drawn on the Sheet goes over to higher graduation, increase the stitches and goes over to lower graduation, decrease the stitches.
- If the half of pattern is drawn on the Sheet, do not forget operation of increasing or decreasing the stitches on another side.

PROCEDURE OF MAKING THE GARMENT

- (1) Pattern drawing on the Sheet in actual size.
- (2) Knitting a tension swatch. And measuring of swatch.
- (3) Setting the Regulator for c/m and m/m.
- (4) Selecting the Stitch measure scale and setting on the Knit-Leader.
- (5) Inserting the Sheet on the Knit-Leader. Turn the Feed dial until the position that a starting line drawn on the Sheet lie on the top of the Stitch measure scale.
- (6) Bring forward the needles. According to the Stitch measure scale and the line drawn on the Sheet, Bring forward the required needles to "B" position.
- (7) Setting the Row counter tripper to resting position.
- (8) Starting to knit with separate yarn. (waste knitting) After waste knitting, knit one row with the Cast-on thread.
- (9) Setting the Row counter tripper to working position.
- (10) Starting to knit with original yarn. Start the Knitting. Before moving the Carriage look at the line drawn on the Sheet and do the operation of increasing, decreasing stitches or short row knitting if required every row.

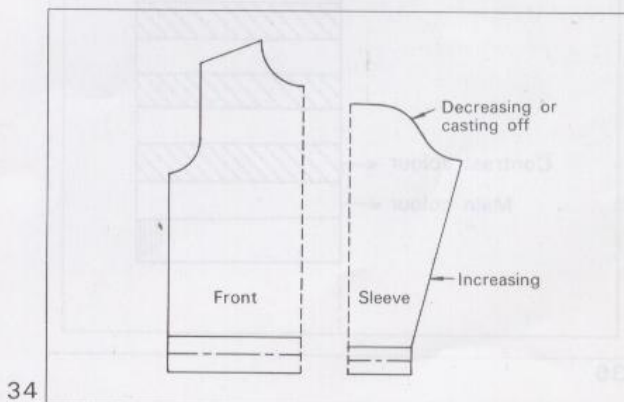
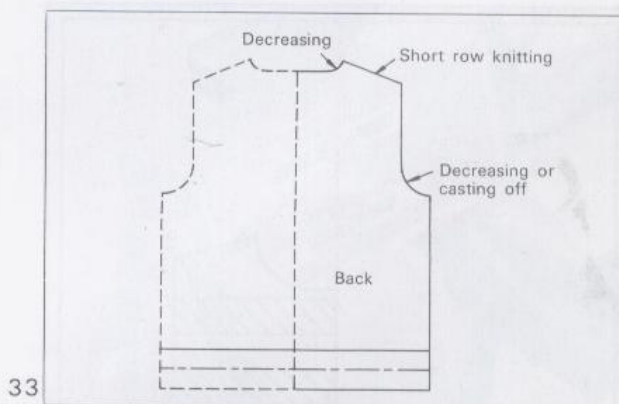
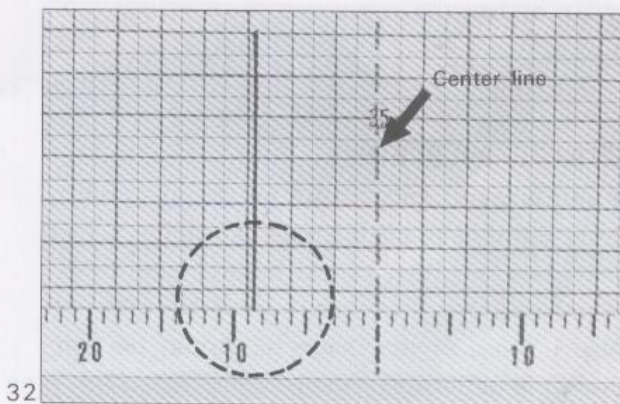
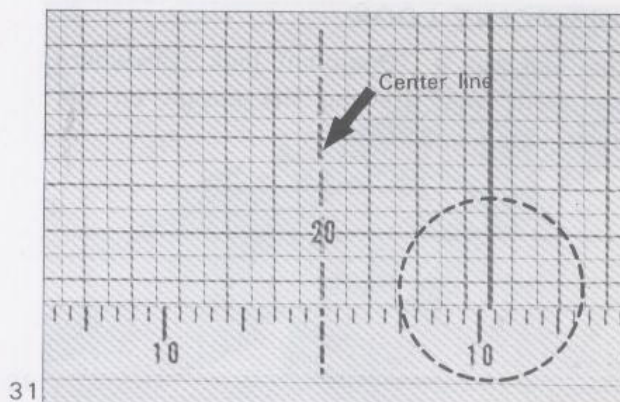

Useful hints

12

ONE-POINT LOOK

You can put a "One-point look" anywhere you want only drawing the design on the sheet. (See Fig. 35)



STRIPE PATTERN

If you want to knit the lateral stripes pattern, draw the stripes on the Sheet so that you can see when the yarn should be changed.

(See Fig. 36)

Also in case of the Diagonal, stripes pattern, draw the pattern as shown on the Fig. 37

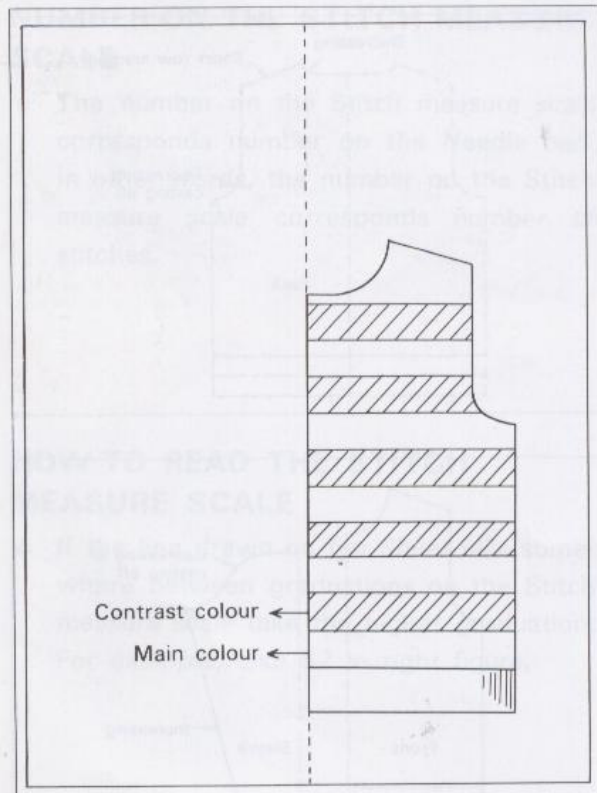

36

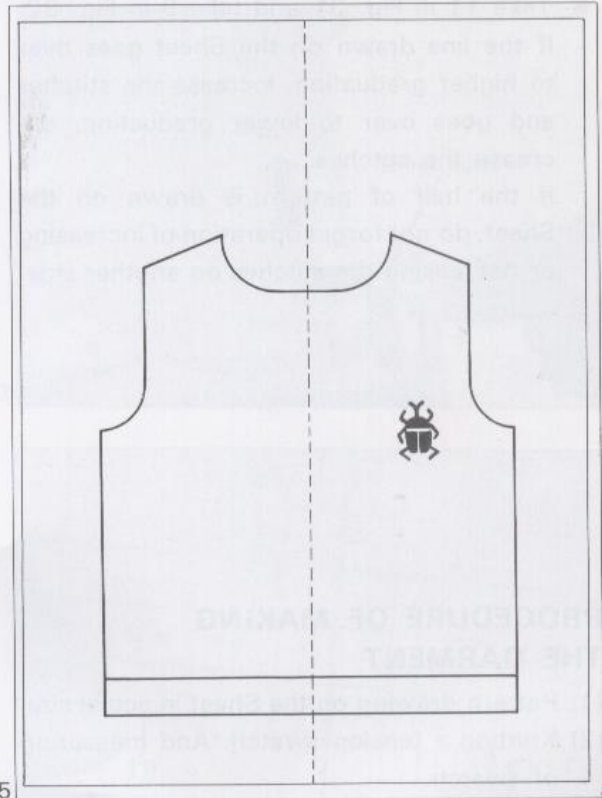

35

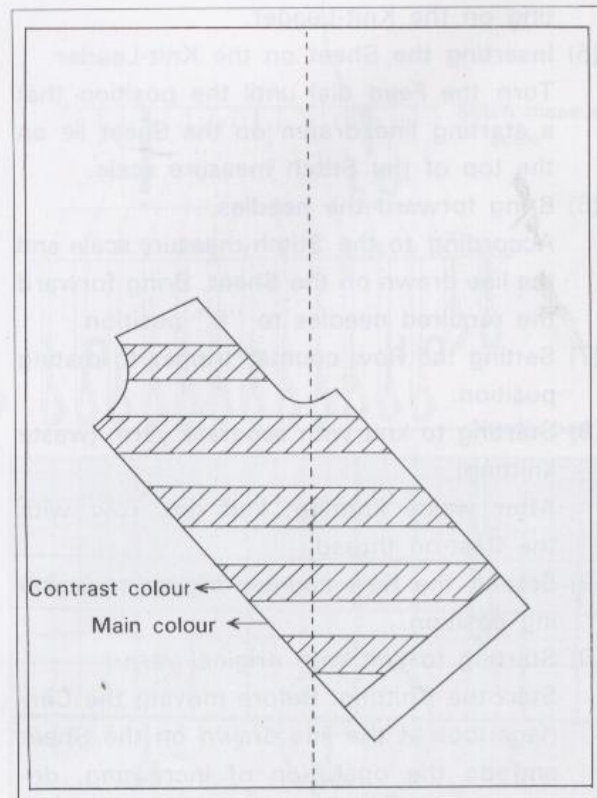

37

KNITTING ERRORS AND CORRECTIONS

* If you made the mistake, correct it in accordance with following method.

- (1) Set the change knob to position "CR", and remove the sinker plate and carriage. Unravell the incorrect rows.
- (2) Turn back the Feeding dial by the same number as the incorrect rows.
- (3) When the yarn stopped at the opposite side to the carriage after the incorrect rows are unravelled, set the Row counting tripper to resting position and move the carriage to the same side as the yarn without knitting.

38

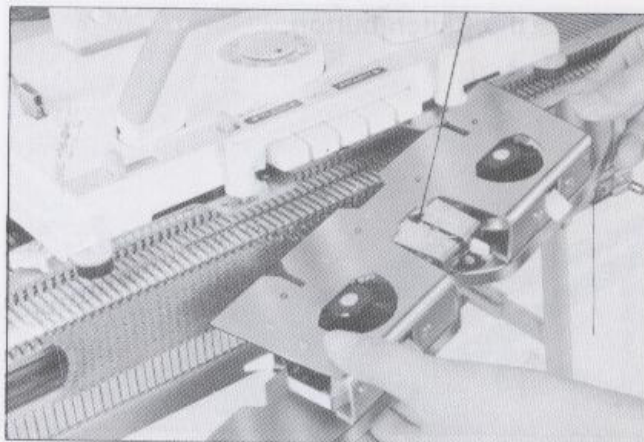

39

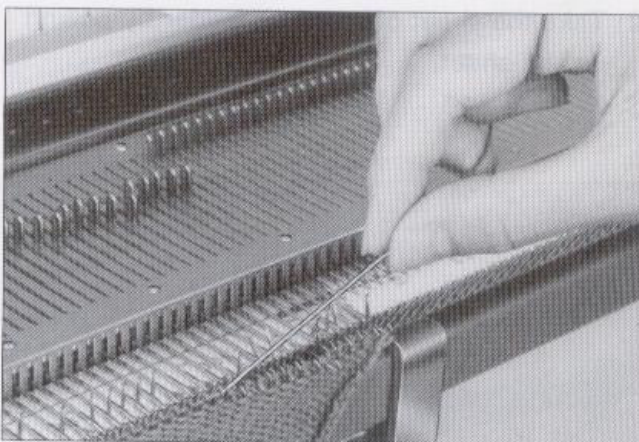

40

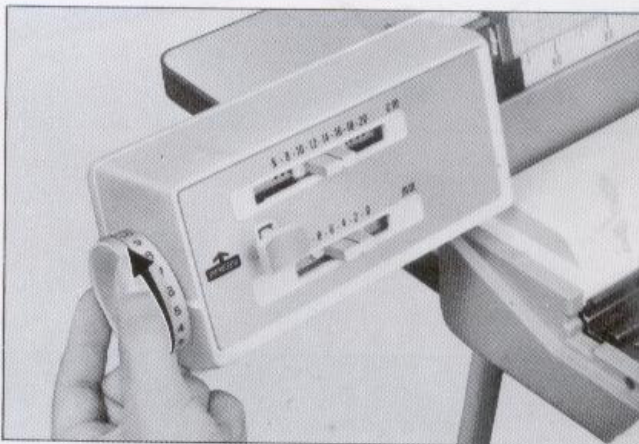

Folding up the Knit-leader

14

(1) Press the Clutch button.

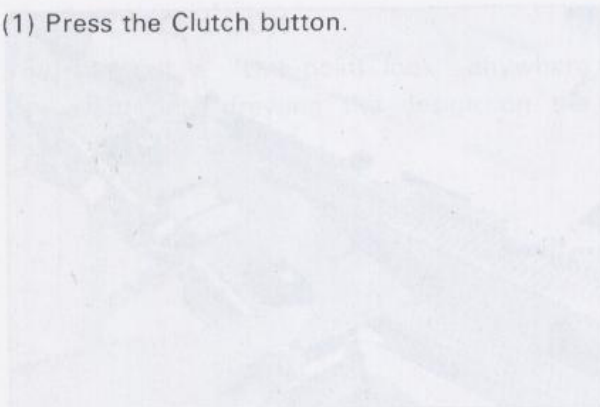

41



(2) Take the sheet off the knit-leader by pulling up the sheet.



42

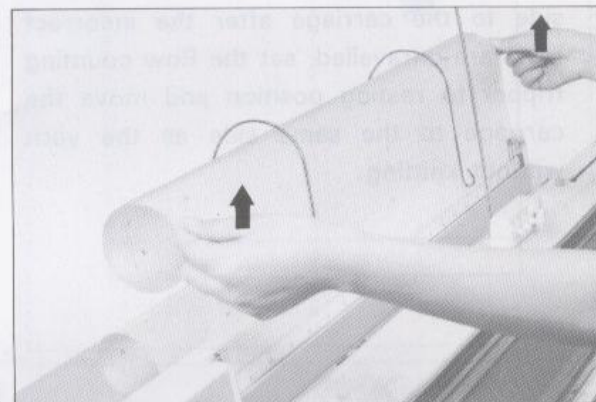

(3) Remove both Sheet guides.



43

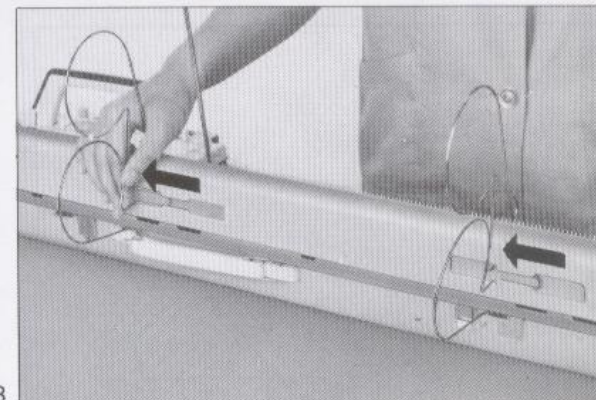

(4) Put the Sheet and Stitch measure scale into the Sheet case.



44

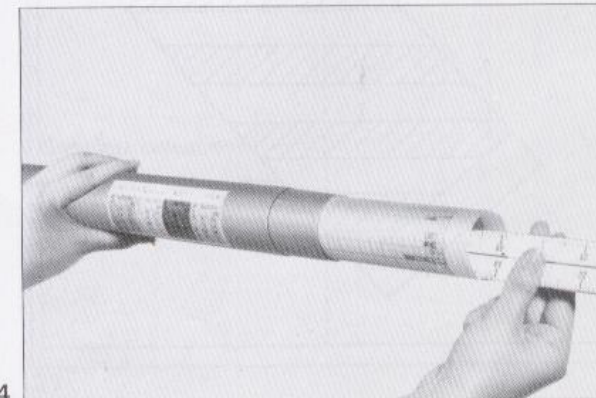

(5) Remove the Knit-leader.

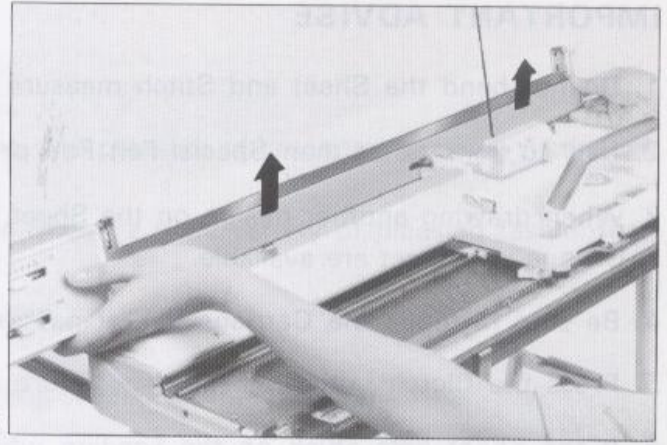

45

(6) Remove both Setting plates.

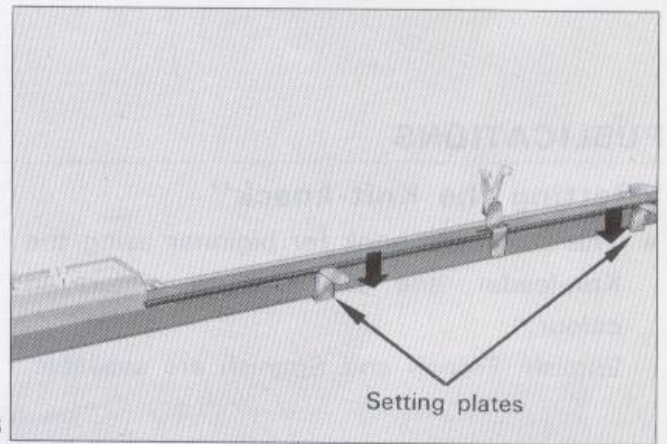

46

(7) Put both Setting plates to the place as shown in the Fig. 47. And fold the Feeding lever.

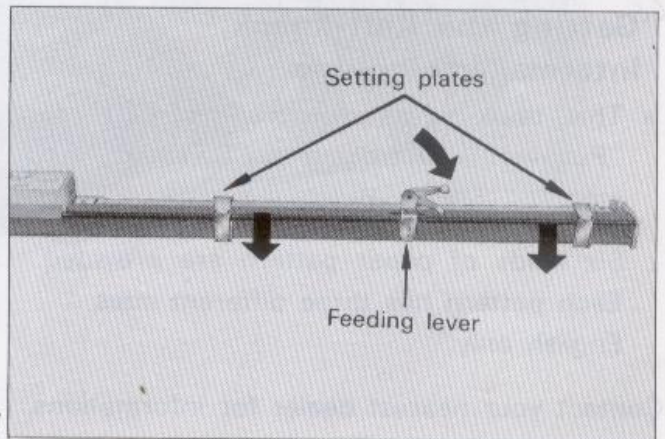

47

IMPORTANT ADVISE

1. Do not bend the Sheet and Stitch measure scale.
2. Use no pens other than Special Felt Pen provided in the Accessories.
3. When drawing another design on the Sheet, use a different colour of Felt pen. Blue, Green and Orange in one set are available.
4. Be sure to move the Carriage until it passes the Feeding lever of the Knit-leader.
5. Press the Clutch button all the way before operating the regulator c/m and m/m.
6. If the Sheet gets stuck on the Feeding wheel, turn the Feeding dial backward to release the Sheet.
7. To erase a pattern, wipe the Sheet with a wet cloth.
If the Sheet gets dirty, clean it with neutral detergent.

PUBLICATIONS

“Getting the Knit-knack”

- * This is a guide book for beginner using the Knit-leader, and explained by picture in colour.
English, French and Spanish are available.



“Getting the Knit-knack” intermediate course

- * This book gives you various hints for “Pullover”, “Cardigan”, “Sweater” and etc...

Six kinds of paper pattern are provided.
Each pattern has three different sizes.
English only.

Contact your nearest dealer for informations.



“HOME KNITTING PATTERN”

* With those Anyone can knit quickly and easily.
For great looking knit-wear you can make yourself.....

Home Knitting Patterns give you the joy, excitement, and pleasure of creating your own distinctive and attractive knitted fashion.

Simply by tracing the pattern onto the Knit Leader Sheet, a wide variety of pleasing fashion can be easily created.

- Vol. 1 Pullovers, skirts, little rompers.
- Vol. 2 Cardigans, little sack-coat.
- Vol. 3 Press, Sleeveless top, Evening skirt, Jacket, Trousers.
- Vol. 4 Vests, Pullover, Cardigan



...Directions for knitting...

The following materials, sizes, and tension dial (T.D.) numbers given for each pattern are for making the garments shown in the pictures. Material and T.D. numbers may be changed according to your preference and thickness of the yarn. If you want to knit a Pullouer with Plain stitch, then please disregard the instructions about the pattern knitting.

18

This is extracted from a Home Knitting Pattern Vol. 1.



LADY'S PULLOVER

Size:

Directions are for medium (M) size.

Materials:

Yarn—Pure wool.

* 4 ply, 400 grams Orange yarn.

* 4 ply, 100 grams White yarn.

Parts to be knitted:

(1) BACK (2) FRONT (3) SLEEVES (4) NECKBAND



To determine knitting gauge, knit and measure a tension swatch in the Plain Stitch.

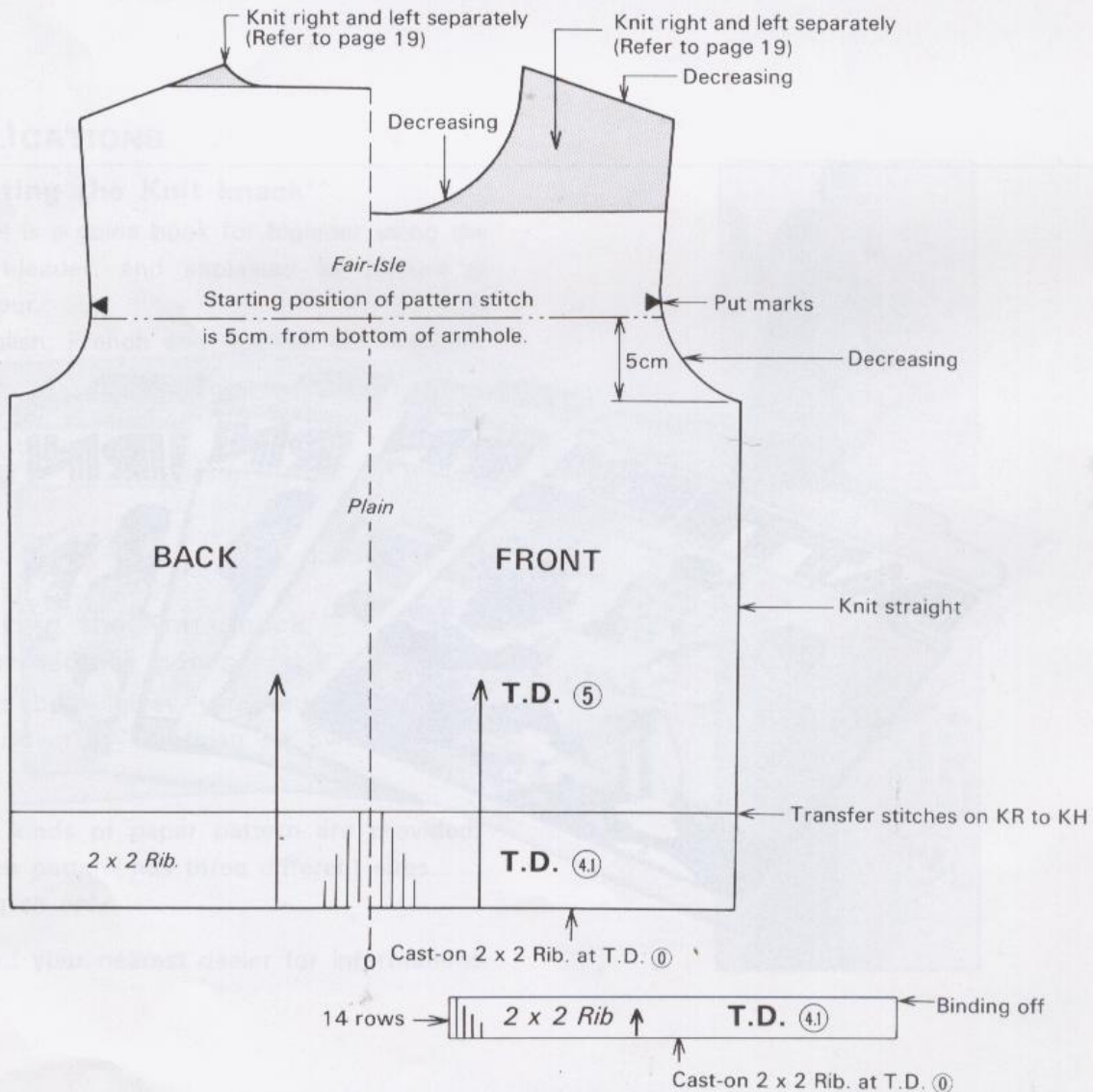

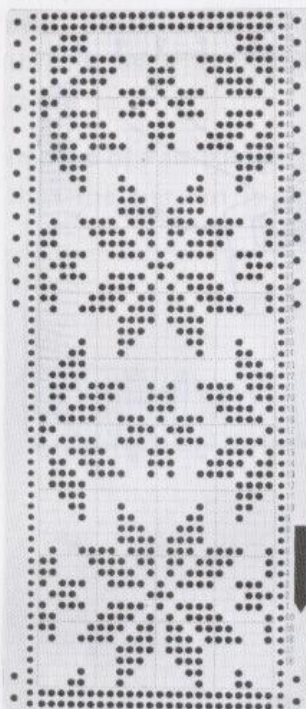

Pattern No. 60
in Punch Card Pattern Book

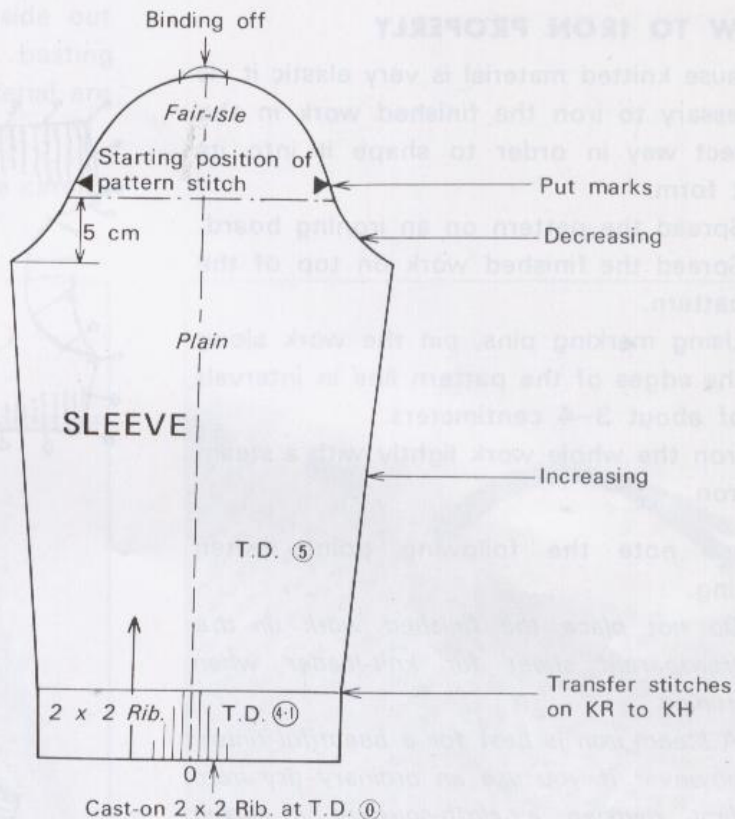

PROCEDURE FOR "PARTIAL KNITTING" AT THE NECK OPENING

FRONT

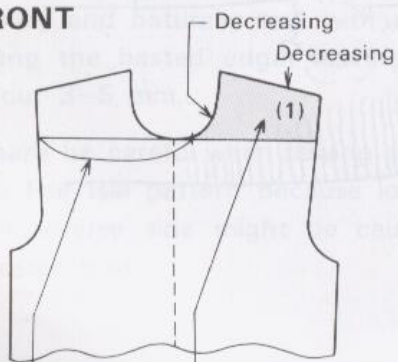

All needles for this part should be placed at the "E" position. Part to be knitted.

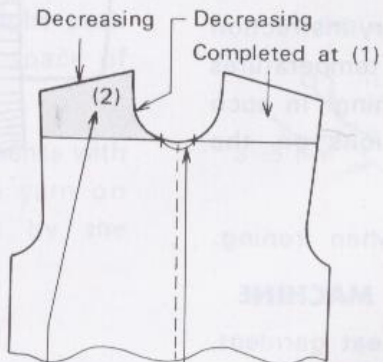

Part to be knitted. Needles for this part only should be placed at the "E" position and left there.

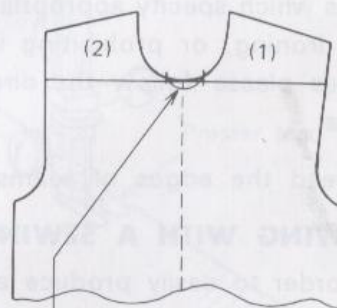

When (1) and (2) are completed, bring the needles for this part to the "B" position and bind off.

BACK * The back should be knitted in the same manner.

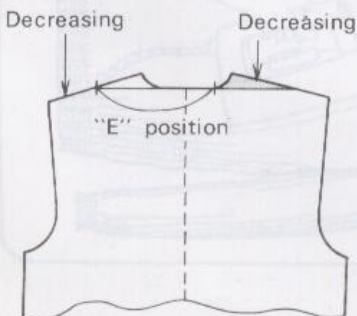

Important points for finishing

20

HOW TO IRON PROPERLY

Because knitted material is very elastic it is necessary to iron the finished work in the correct way in order to shape it into its best form.

1. Spread the pattern on an ironing board.
2. Spread the finished work on top of the pattern.
3. Using marking pins, pin the work along the edges of the pattern line in intervals of about 3–4 centimeters.
4. Iron the whole work lightly with a steam iron.

Please note the following points when ironing.

- * *Do not place the finished work on the transparent sheet for knit-leader when ironing.*
- * *A steam iron is best for a beautiful finish, however if you use an ordinary dry iron, first dampen a cloth-squeeze it almost dry—and place it on top of the finished work then iron lightly and evenly over it.*

Synthetic fiber yarns usually carry instruction tags which specify appropriate temperatures for ironing, or prohibiting ironing. In such cases please follow the directions on the tags.

Spread the edges of seams when ironing.

SEWING WITH A SEWING MACHINE

In order to easily produce a neat garment, it is recommended to use a sewing machine for all necessary sewing.

Any type of sewing machine can be used because only straight stitch sewing is necessary.

Stretchy thread of the same color as the yarn used for knitting is most suitable for sewing. (Or, silk thread can also be used.)

Use the sewing machine needle for cloth of medium thickness.

A suitable number of stitch length dial is 3.

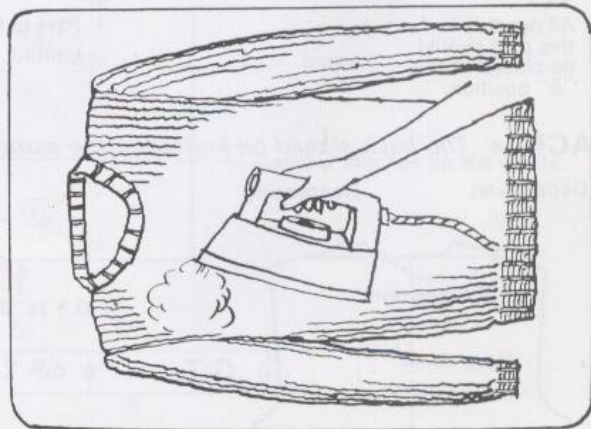
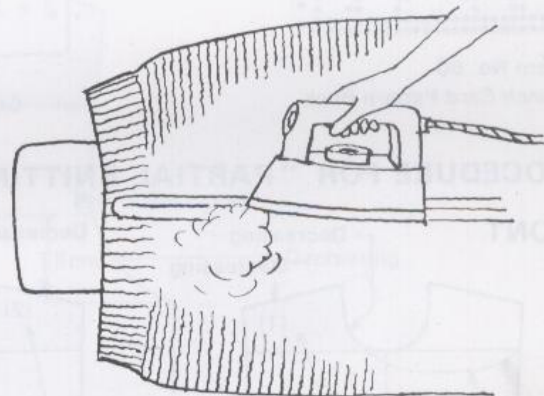
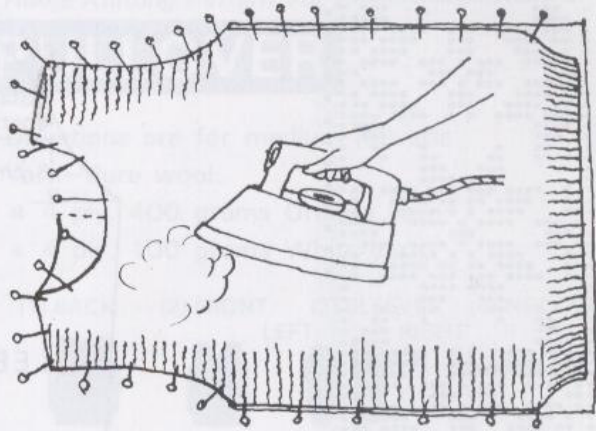

Put two knitted pieces together inside out and baste with binding wire or basting thread, as if the edges of the material are rolled in.

In case of Fair Isle patterns, please be careful that the pattern is properly aligned.

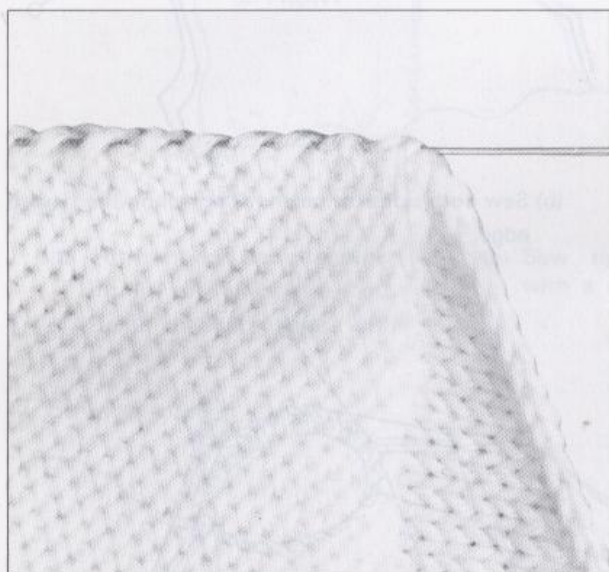

Basting with binding wire

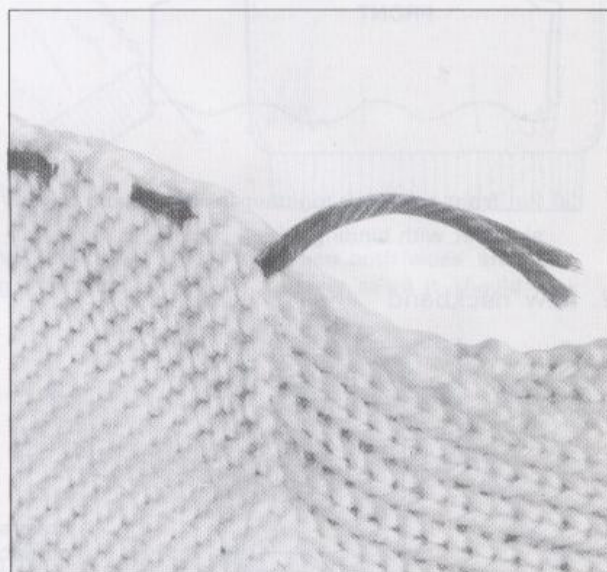

Basting with thread

Slowly and naturally sew with a slight push along the basted edge, leaving a space of about 3–5 mm.

Please be careful when sewing garments with the Fair Isle pattern because loose yarn on the reverse side might be caught by the presser foot.

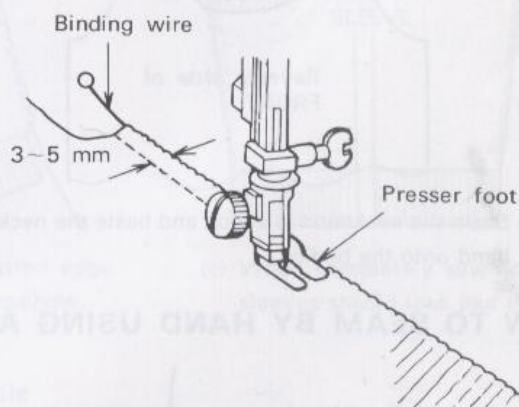

Please be careful not to cut the thread too strongly. It is easier to sew back if some places are damaged.

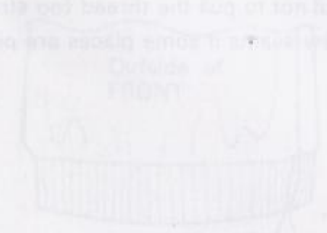

Sewing procedure for finishing

22

1. Shoulders (right and left)

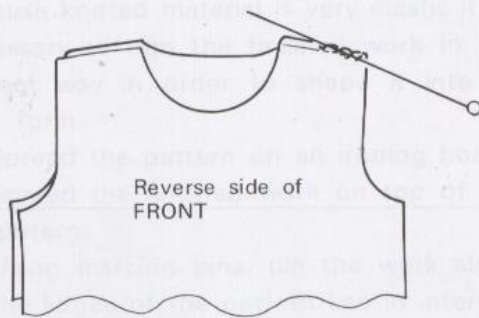

(a) Put front and back together inside out and baste shoulder with binding wire.

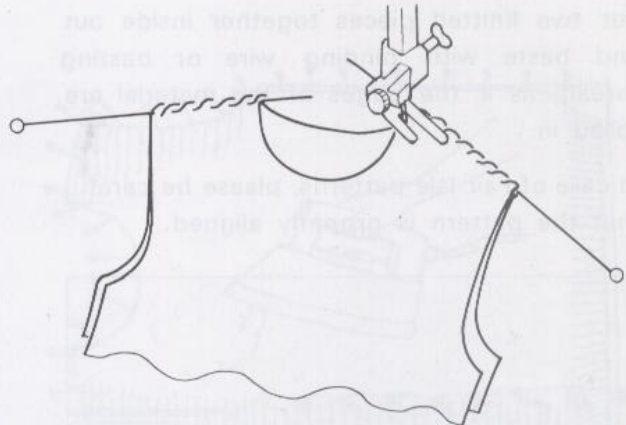

2. Sew neckband

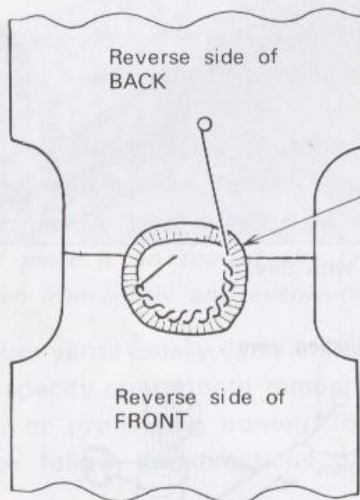

(a) Seam the neckband in a loop and baste the neckband onto the bodice.

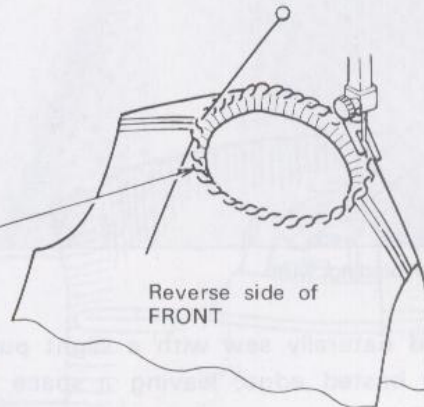

HOW TO SEAM BY HAND USING A TAPESTRY NEEDLE

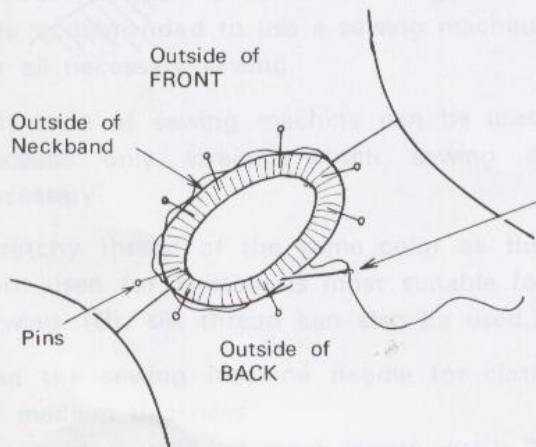

Please be careful not to pull the thread too strongly. It is easier to sew seams if some places are pinned.

3. Sew sides

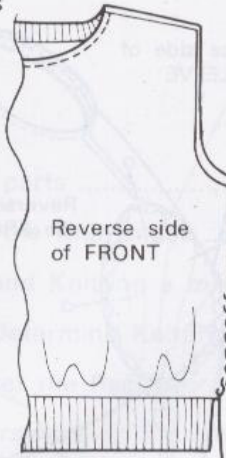

(a) Put front and back together inside out and baste both right and left sides with binding wire.

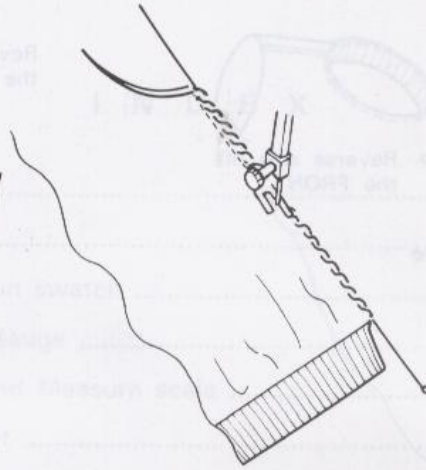

(b) Sew right and left sides with a Sewing machine.

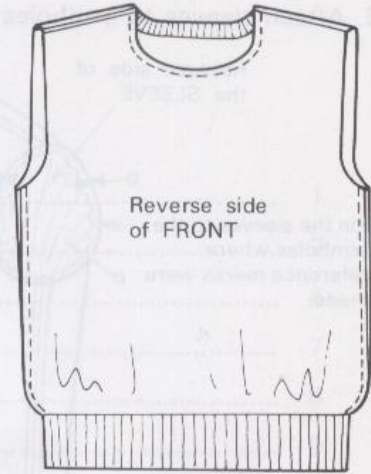

(c) When both sides are completely sewn it should look like this.

4. Sew sleeves

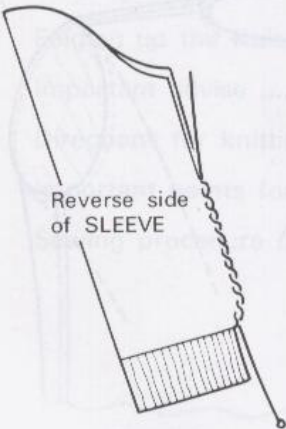

(a) Fold sleeves inside out as shown below and baste with binding wire.

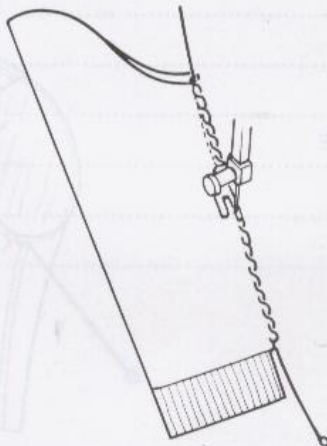

(b) Sew along the wired edge with a Sewing machine.

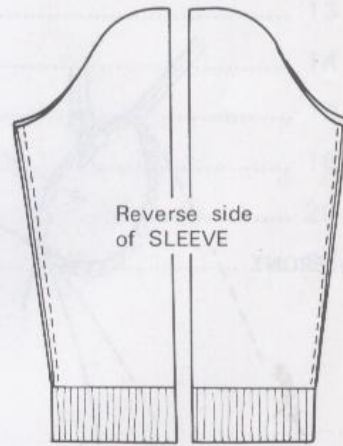

(c) When completely sewn the sleeves should look like this.

5. Seam bodice rib and cuffs with a tapestry needle

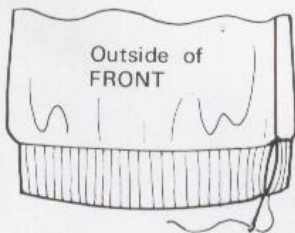

(a) Seam ribbing of both sides of the bodice.



(b) Seam cuffs.

6. Attach sleeves to armholes

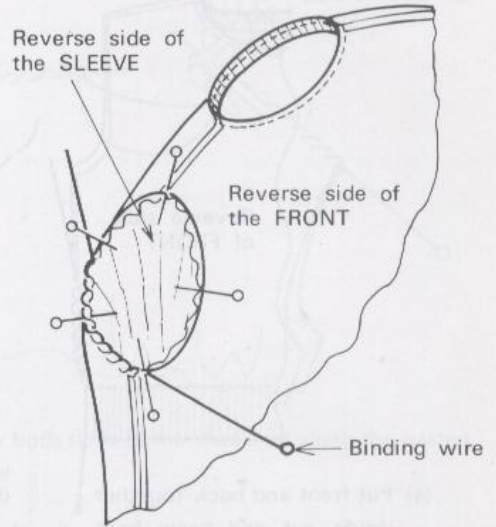
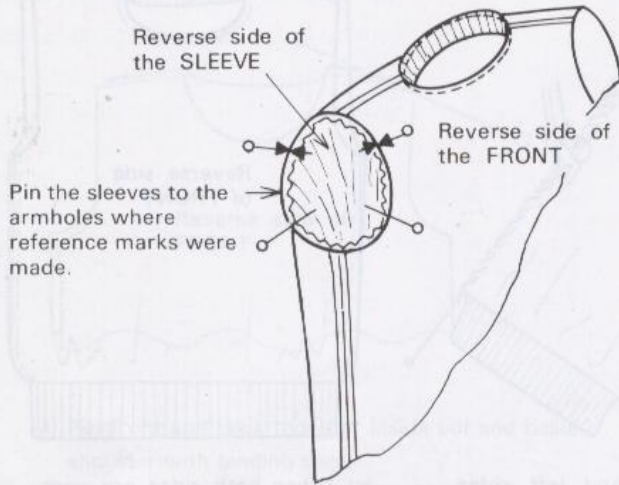

(a) Put bodice and sleeves inside out and pin the edges of the sleeves to the edges of the armholes where reference marks were previously made.

(b) Baste the sleeves to the armholes using binding wire or basting thread.

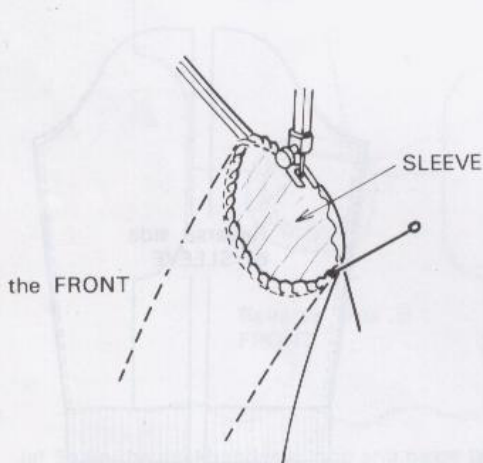

(c) Sew basted parts with a Sewing machine.

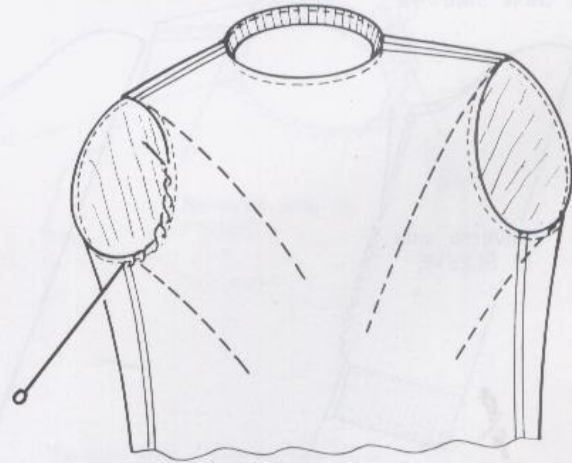

(d) Take out the basting thread or binding wire.

7. Finished garment



I N D E X

Name of parts	1
Installing the Knit-leader	2
Tension and Knitting a tension swatch	4
How to Determine Knitting Gauge	7
How to set the Regulators and Measure scale	8
Pattern drawing on the Sheet	9
How to insert the Sheet	9
How to read the Stitch measure scale	10
Procedure of making the garment	11
Useful hints	12
Knitting errors and corrections	13
Folding up the Knit-leader	14
Important advise	16
Directions for knitting	18
Important points for finishing	20
Sewing procedure	22